

TECTUM FINALE PB  
4' x 4' x 1" BEVSQ PANEL  
LONG EDGES BEVELED  
SHORT EDGES SQUARE  
ITEM 8255W4L04T10

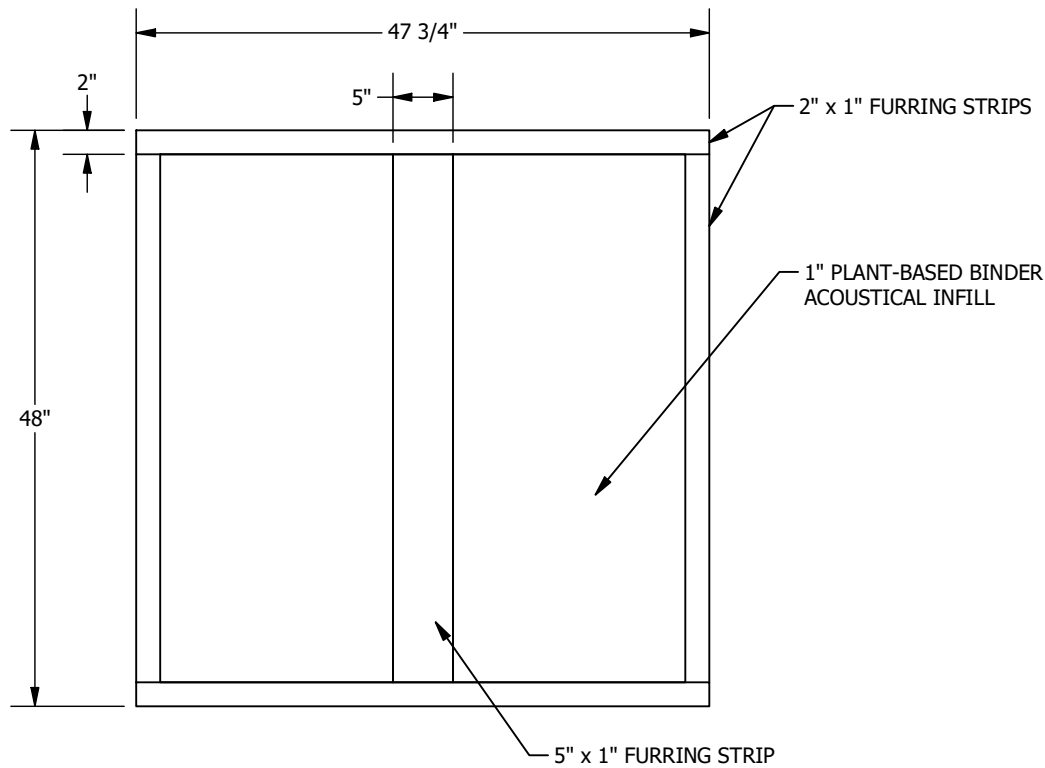

**Armstrong**<sup>®</sup>  
World Industries

TECTUM FINALE PB  
4' x 4' x 1" BEVSQ PANEL

DRAWN BY: PRW

DATE: 8/31/2023

PD

These drawings show typical conditions which the Armstrong products depicted are installed. They are not a substitute for an architect's or engineer's plan and do not reflect the unique requirements of local building codes, laws, statutes, ordinances, rules and regulations (Legal Requirements) that may be applicable for a particular installation. Armstrong does not warrant, and assumes no liability for the accuracy or completeness of the drawings for a particular installation or their fitness for a particular purpose. The user is advised to consult with a duly licensed architect or engineer in the particular locale of the installation to assure compliance with all legal requirements. Armstrong is not licensed to provide professional architecture or engineering design services.