

NOTES:

1. THE CONSTRUCTION OF 2X4 TECTUM DESIGNART LINES FINALE PB PANELS IS IDENTICAL FOR ALL DESIGNART PANEL DESIGNS

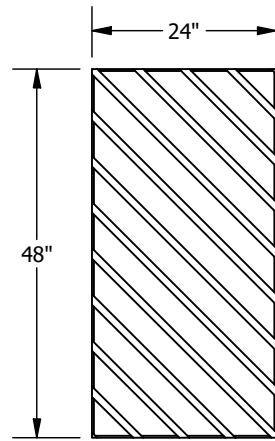

BP6383D41T10-???
TILTS C 2X4 TEC DAL FINALE PB PANEL
SCALE 1 : 25

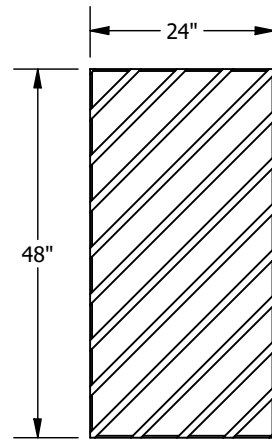

BP6383D40T10-???
TILTS B 2X4 TEC DAL FINALE PB PANEL
SCALE 1 : 25

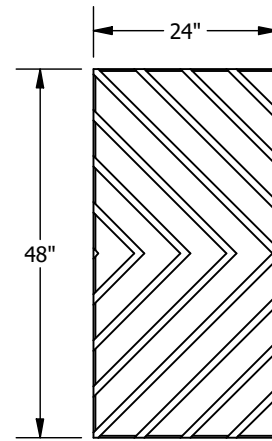

BP6383D42T10-???
TILTS D 2X4 TEC DAL FINALE PB PANEL
SCALE 1 : 25

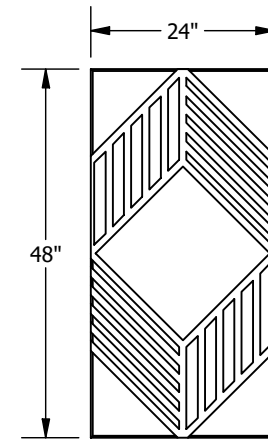

BP6383D48T10-???
ILLUSIONS B 2X4 TEC DAL FINALE PB PANEL
SCALE 1 : 25

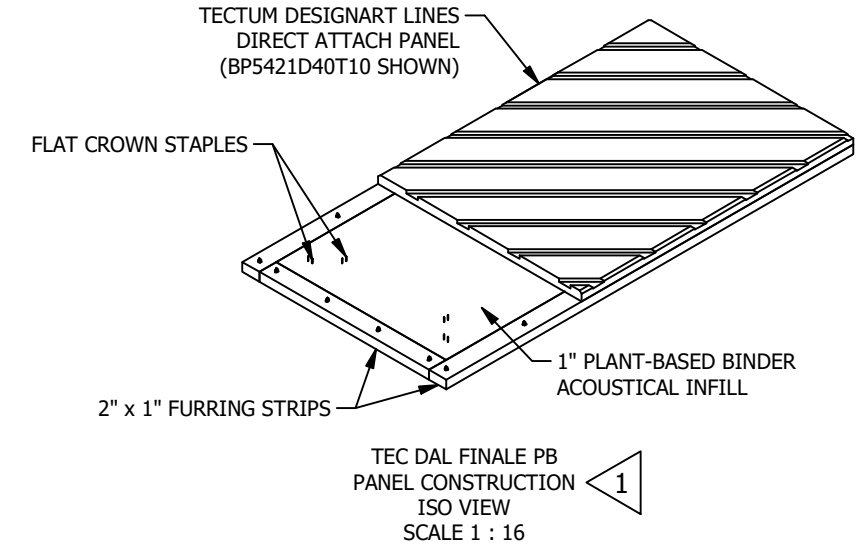

TEC DAL FINALE PB
PANEL CONSTRUCTION
ISO VIEW
SCALE 1 : 16

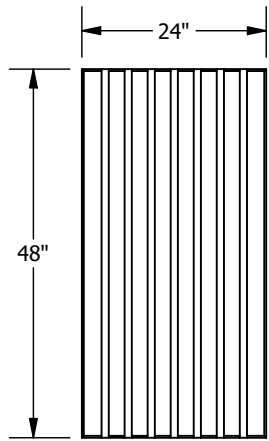

BP6383D50T10-???
STRINGS B 2X4 TEC DAL FINALE PB PANEL
SCALE 1 : 25

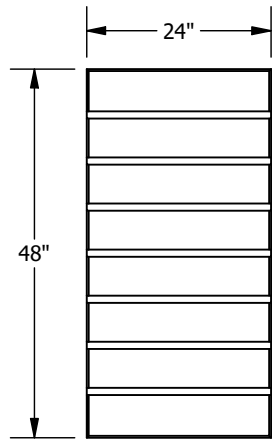

BP6383D47T10-???
BANDS C 2X4 TEC DAL FINALE PB PANEL
SCALE 1 : 25

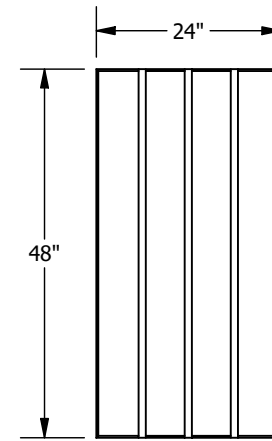

BP6383D46T10-???
BANDS B 2X4 TEC DAL FINALE PB PANEL
SCALE 1 : 25

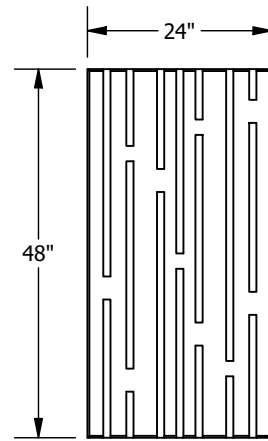

BP6383D52T10-???
SIGNALS B 2X4 TEC DAL FINALE PB PANEL
SCALE 1 : 25

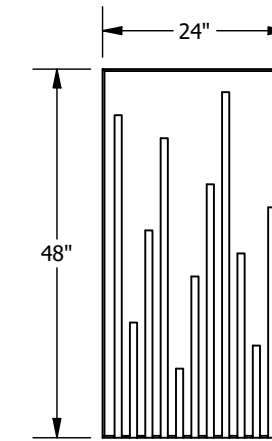

BP6383D54T10-???
LEVELS 2X4 TEC DAL FINALE PB PANEL
SCALE 1 : 25

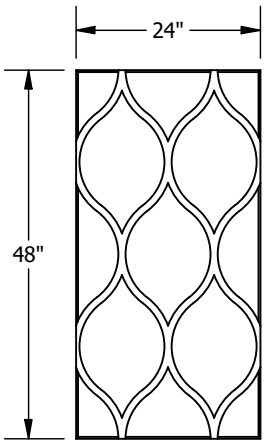

BP6383D51T10-???
DROPLETS B 2X4 TEC DAL FINALE PB PANEL
SCALE 1 : 25

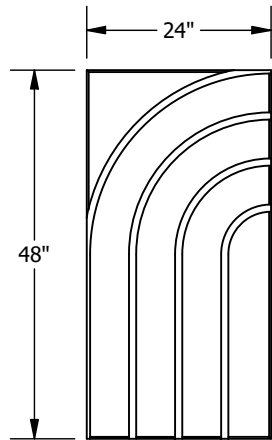

BP6383D43T10-???
RETRO 2X4 TEC DAL FINALE PB PANEL
SCALE 1 : 25

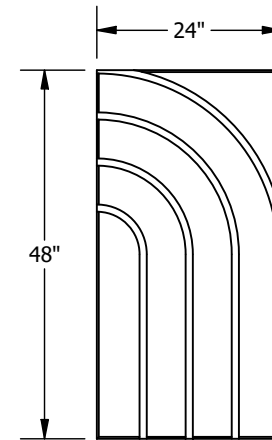

BP6383D44T10-???
RETRO B 2X4 TEC DAL FINALE PB PANEL
SCALE 1 : 25

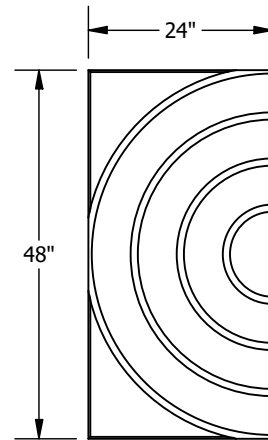

BP6383D45T10-???
RINGS 2X4 TEC DAL FINALE PB PANEL
SCALE 1 : 25

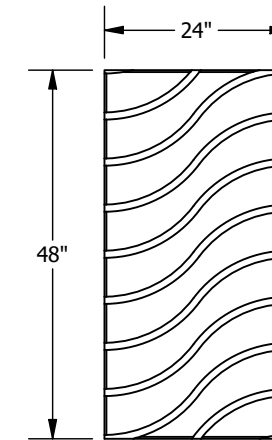

BP6383D49T10-???
CURRENTS B 2X4 TEC DAL FINALE PB PANEL
SCALE 1 : 25

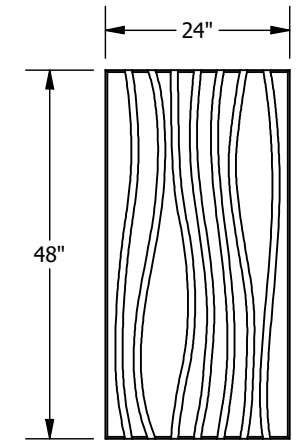

BP6383D53T10-???
CONTOURS 2X4 TEC DAL FINALE PB PANEL
SCALE 1 : 25



TECTUM DESIGNART LINES FINALE PB - 2X4 PANELS

DRAWN BY: PRW DATE: 5/10/2024 PD

These drawings show typical conditions which the Armstrong products depicted are installed. They are not a substitute for an architect's or engineer's plan and do not reflect the unique requirements of local building codes, laws, statutes, ordinances, rules and regulations (Legal Requirements) that may be applicable for a particular installation. Armstrong does not warrant, and assumes no liability for the accuracy or completeness of the drawings for a particular installation or their fitness for a particular purpose. The user is advised to consult with a duly licensed architect or engineer in the particular locale of the installation to assure compliance with all legal requirements. Armstrong is not licensed to provide professional architecture or engineering design services.