

HARDWARE INSTALLATION

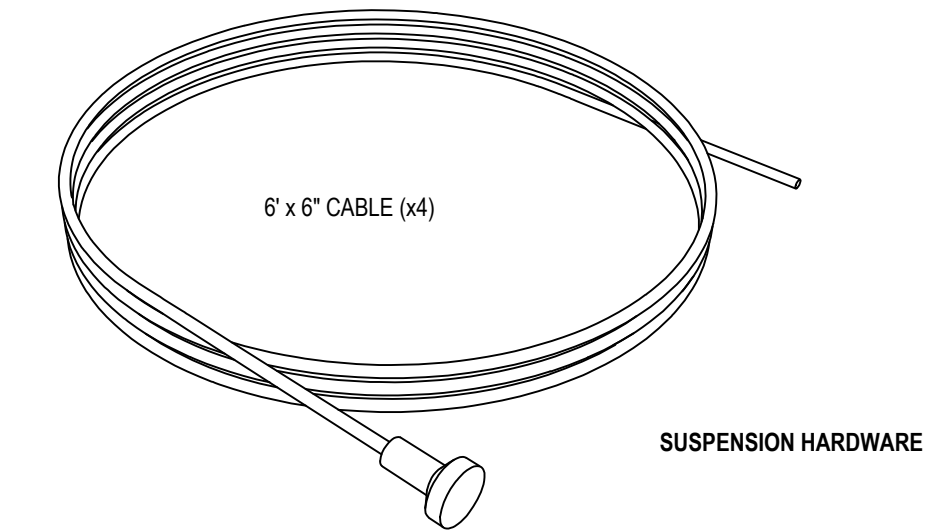

SUSPENSION HARDWARE

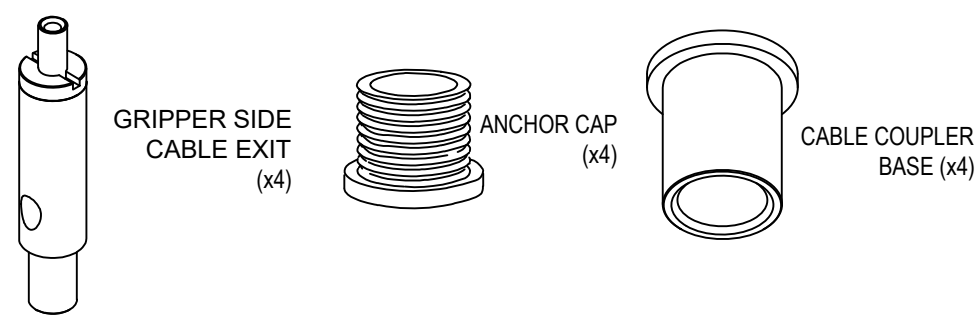
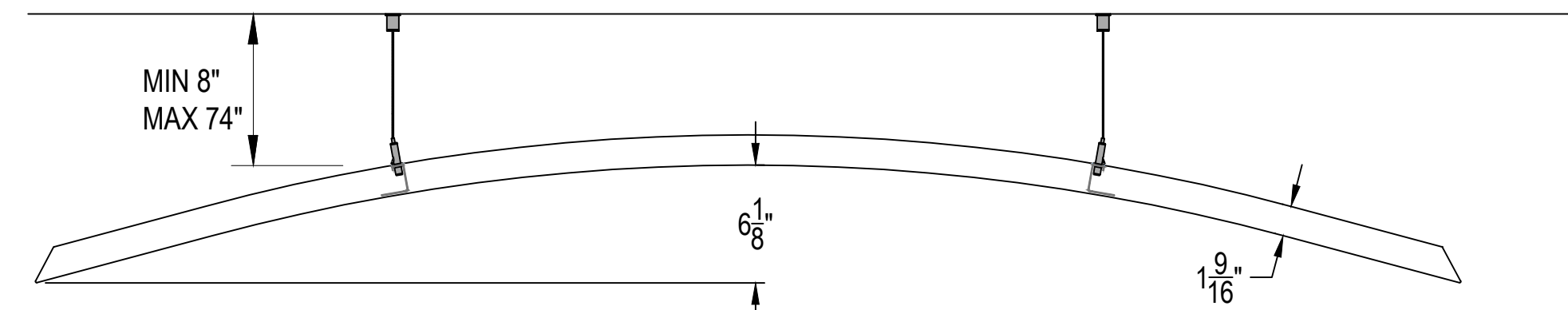

ELEVATION VIEW

HILL
(ALL DIMENSIONS NOMINAL)
74- $\frac{1}{2}$ " X 46- $\frac{1}{2}$ " X 1- $\frac{3}{8}$ "

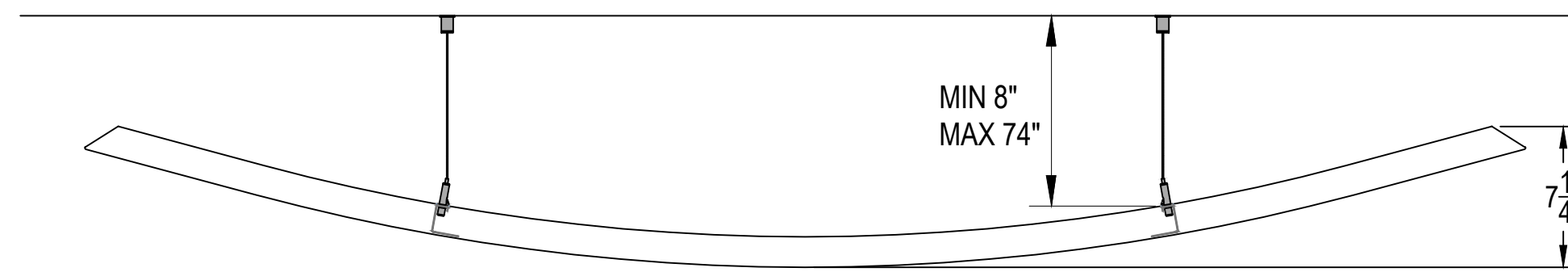

ELEVATION VIEW

VALLEY
(ALL DIMENSIONS NOMINAL)
74- $\frac{1}{2}$ " X 46- $\frac{1}{2}$ " X 1- $\frac{3}{8}$ "

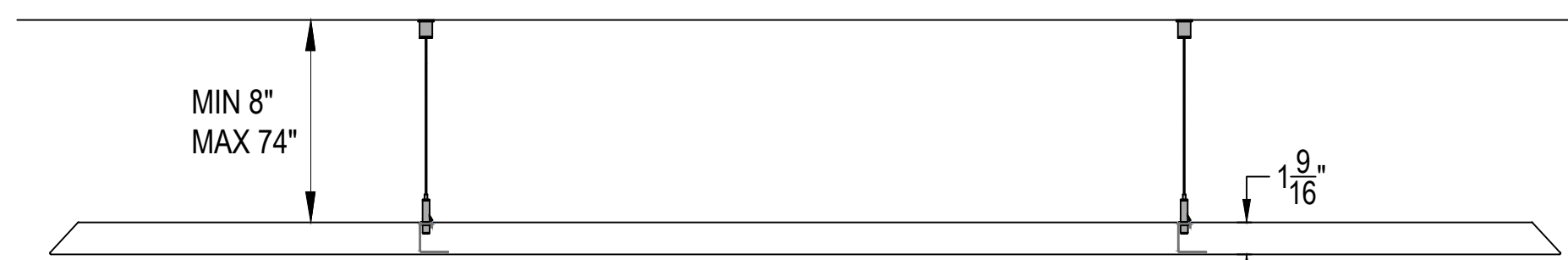

ELEVATION VIEW

FLAT
(ALL DIMENSIONS NOMINAL)
74- $\frac{1}{2}$ " X 46- $\frac{1}{2}$ " X 1- $\frac{3}{8}$ "

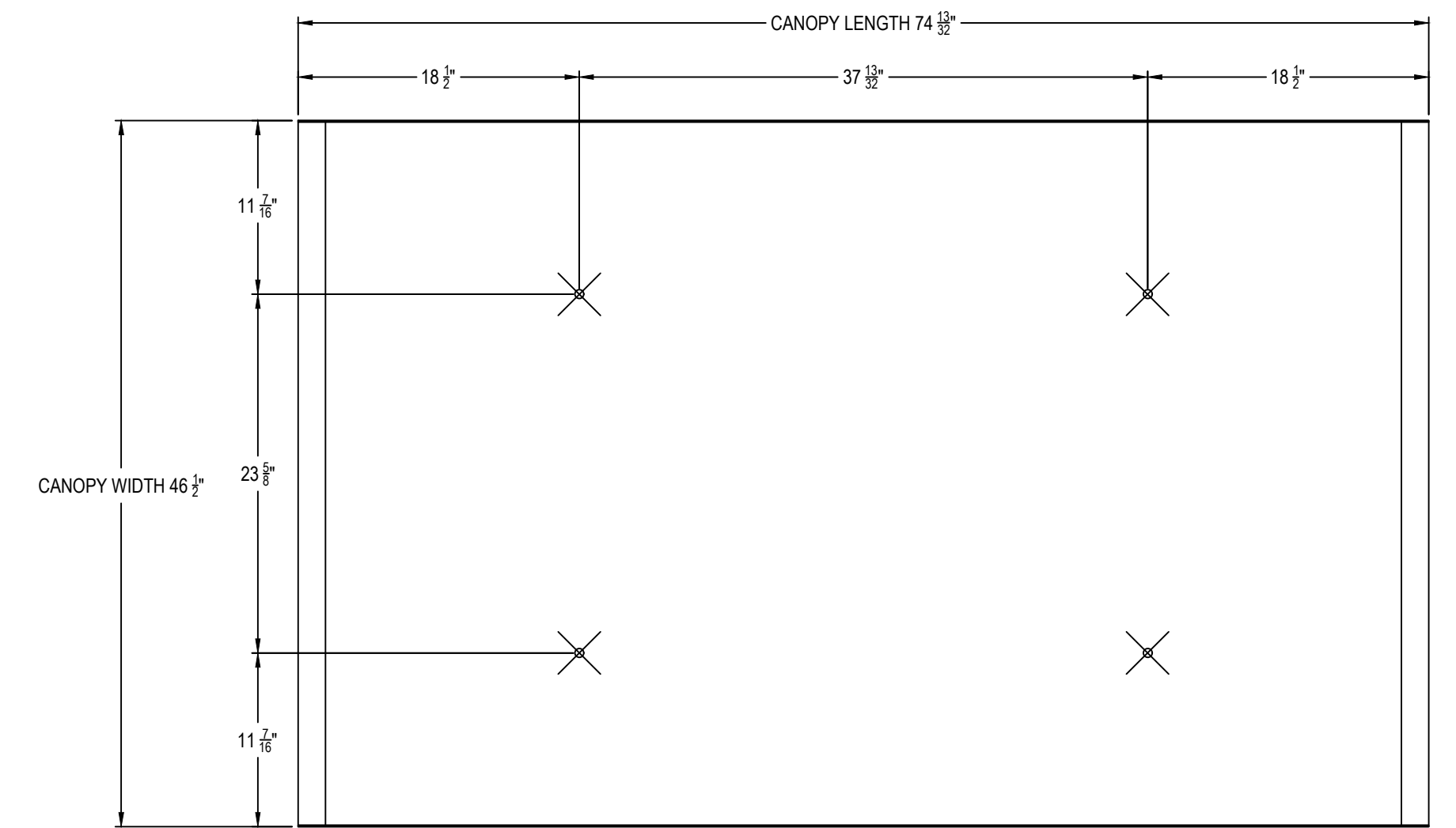

PLAN VIEW
VALLEY PANEL

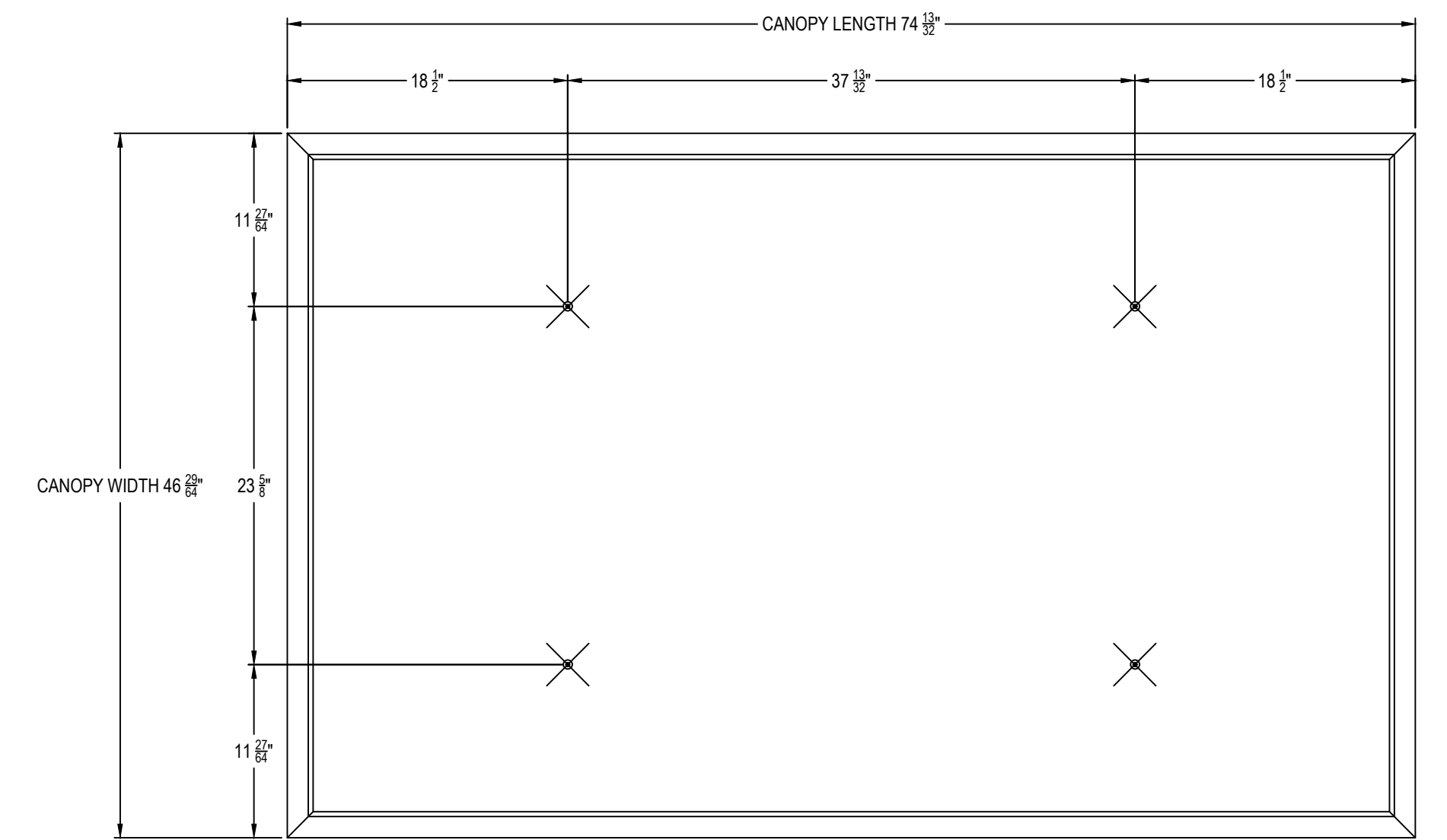

PLAN VIEW
FLAT PANEL

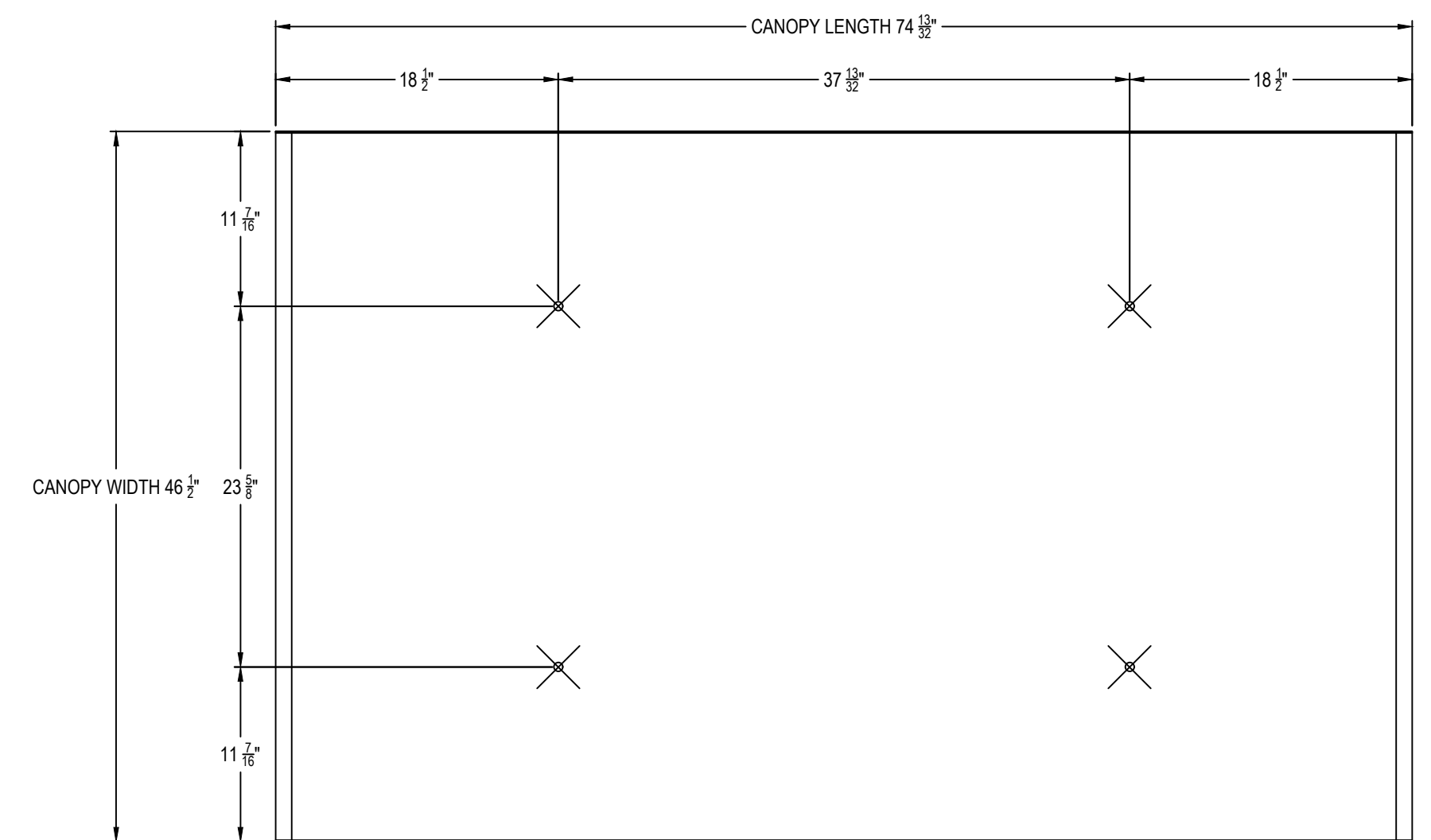

PLAN VIEW
HILL PANEL

<small>These drawings show typical conditions in which the Armstrong product depicted is installed. They are not a substitute for an architect or engineer's plan and do not reflect the unique requirements of local building codes, laws, ordinances, rules and regulations (Legal Requirements) that may be applicable for a particular installation.</small>		PROJECT NAME: METALWORKS CANOPIES LITERATURE DETAILS	
<small>Armstrong does not warrant, and assumes no liability for the accuracy or completeness of the drawings for a particular installation or their fitness for a particular purpose. The user is advised to consult with a duly licensed architect or engineer in the particular locale of the installation to assure compliance with all Legal Requirements.</small>	DWG. NO. SHEET 1	REV: .	DATE: .
<small>Armstrong is not licensed to provide professional architecture or engineering design services.</small>	DATE: 7/18/19	SCALE:	DESC.:
Tech	DRAWN BY: MAP	CHK BY:	ARMSTRONG
<small>ARMSTRONG CEILING SYSTEMS * ARMSTRONG WORLD INDUSTRIES, INC. * Lancaster, PA * Phone: 877-ARMSTRONG</small>			