

NOTES:
 THE EXAMPLE LAYOUT AND CORRESPONDING BOM SHOWN ARE MEANT TO BE USED AS REFERENCE POINTS WHEN SPECIFYING A DESIGNFLEX SYSTEM.
 IF YOU PLAN TO USE THE EXACT LAYOUT SHOWN, OR ANY VARIATION THEREOF, CONSIDER THE FOLLOWING NOTES:

- 1) DRAWING DETAILS SHOW A CEILING PLAN VIEW WHICH IS FROM A PLENUM POSITION LOOKING DOWN ONTO THE BACKSIDE OF THE CEILING SYSTEM. BOM LISTS DESCRIPTIONS THAT COORDINATE WITH THE DATA PAGES, AND THESE ITEM DESCRIPTIONS ARE BASED ON VIEWING THE FACE OF THE PRODUCTS.
- 2) ANGLE BRACKETS AND CORNER BRACKETS ARE INSTALLED AT STANDARD 6" OC ROUTE HOLE INCREMENTS ALONG THE MAIN BEAMS - ALL MAIN BEAMS ARE INSTALLED WITH ALIGNED ROUTE HOLES.
- 3) ANGLE BRACKETS USED WITHIN LAYOUTS HAVE SCREWS, WASHERS, AND NUTS INCLUDED WITH THEM FOR FASTENING TO MAIN BEAMS. IF CORNER BRACKETS ARE USED IN THE SYSTEM THEY WILL REQUIRE SCREWS THAT ARE NOT INCLUDED AND NEED TO BE SUPPLIED BY OTHERS.
- 4) SCREWS, RIVETS, AND OTHER GENERAL FASTENERS THAT ARE NOT INCLUDED IN BOM OR IN DETAILS BELOW, NEED TO BE SUPPLIED BY OTHERS. REFER TO INSTALLATION INSTRUCTIONS FOR DETAILS ON REQUIRED FASTENERS.
- 5) HANGER WIRE LOCATIONS SHOWN BELOW ARE ONLY SUGGESTIONS BASED ON EXAMPLE LAYOUT AND CAN BE MOVED IN ACCORDANCE WITH FOLLOWING REQUIREMENT - HANGER WIRES ARE REQUIRED ALONG MAINS WITHIN 24" OF THE WALL AND NO MORE THAN 48" O.C THEREAFTER.
- 6) CONDITIONS SHOWN ARE FOR NON-SEISMIC INSTALLATIONS (SEISMIC DESIGN CATEGORY A,B) - REFERENCE INSTALLATION INSTRUCTIONS FOR CONSIDERATIONS AND REQUIREMENTS FOR SEISMIC INSTALLATIONS.
- 7) DETAILS BELOW AND BOM ARE SUBJECT TO CHANGES AT THE PERIMETER BASED ON THE LAYOUT (LINEAR FEET OF PERIMETER, FULL SIZE VS. CUT PANELS, BORDER PANEL INSTALLATION METHOD).
- 8) 7800 WALL ANGLE PERIMETER SHOWN BELOW. REFERENCE INSTALLATION INSTRUCTIONS FOR DETAILS ON ALTERNATIVE PERIMETER SOLUTIONS.
- 9) BOM DOES NOT ACCOUNT FOR THE USE OF SCRAP OR EXCESS MATERIAL CUT FROM OTHER ITEMS.
- 10) REFER TO MASTER PARTS SHEET, PANEL SHEET, AND INSTALLATION INSTRUCTIONS ILLUSTRATIONS SHEET FOR SPECIFIC DETAIL VIEWS AND DIAGRAMS OF ALL PARTS AND PIECES LISTED IN BOM.

SH-0001-3 BILL OF MATERIALS				
ITEM	QTY	STOCK NUMBER	DESCRIPTION	DESCRIPTION
1	16	7800	Angle Molding	
2	76	7500/7501	12" ID/HD Suprafine Main Beam	
3	120	75AB45L	Suprafine 45 Deg. Left Angle Bracket	
4	120	75AB45R	Suprafine 45 Deg. Right Angle Bracket	
5	122	75AB45D	Suprafine 45 Deg. Double Angle Bracket	
6	245	XM754524	Suprafine 45 Deg. Cross Tee - 24in MBS	
7	26	XM7524	Suprafine Perimeter Cross Tee - 24in MBS	
8	48	BERC2	2" Beam End Retaining Clip	
9	18	XTAC	Cross Tee Adapter Clip	
10	42	PAC	Perimeter Angle Clip	
11	156	100001	Lyra 9/16" Square Tegular - 45 Deg. 48 in Base Triangle	
12	66	100014	Lyra 9/16" Square Tegular - 45 Deg. 48 in Base Right Parallelogram	
13	66	100015	Lyra 9/16" Square Tegular - 45 Deg. 48 in Base Left Parallelogram	
14	209	7891	12 Gauge Hanger Wire (Qty. = number of min. hanging point locations)	

EXAMPLE LAYOUT AND BOM SHOWN WITH LYRA PANELS AND SUPRAFINE SUSPENSION SYSTEM

PANEL PRODUCT FAMILIES COMPATIBLE WITH THIS LAYOUT:
 LYRA, OPTIMA, CALLA, METALWORKS TEGULAR, AND WOODWORKS TEGULAR

SUSPENSION SYSTEMS COMPATIBLE WITH THIS LAYOUT:
 SUPRAFINE ID/HD

SIDE A - REPRESENTS A BORDER CONDITION UTILIZING A SINGLE GRID MEMBER CONNECTION TO THE PERIMETER

SIDE B - REPRESENTS A BORDER CONDITION UTILIZING A SINGLE GRID MEMBER CONNECTION OR MULTIPLE GRID MEMBER CONNECTIONS TO THE PERIMETER

REFERENCE INSTALLATION INSTRUCTIONS FOR FURTHER DETAILS ON HOW THESE BORDER CONDITIONS ARE INSTALLED

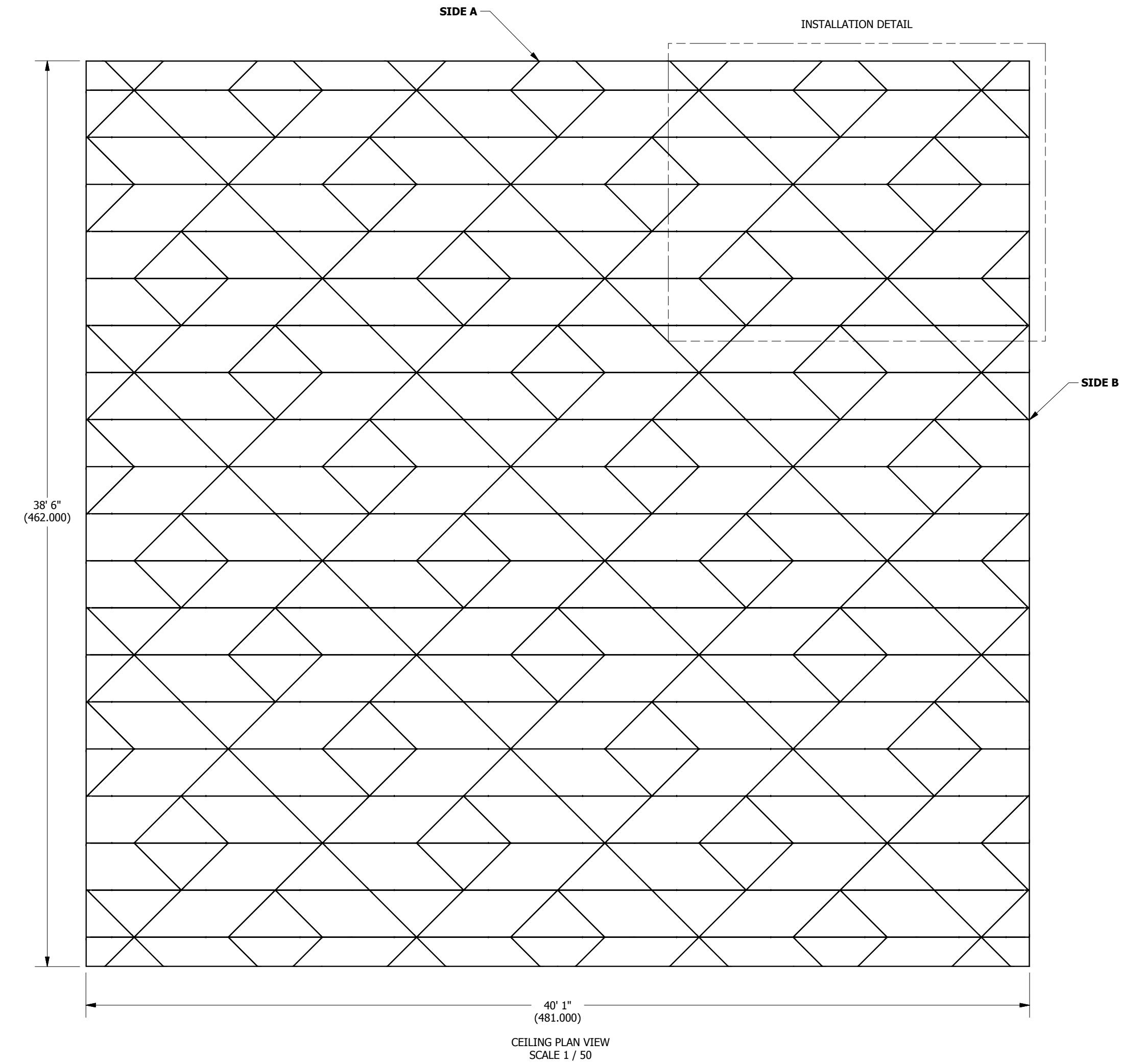
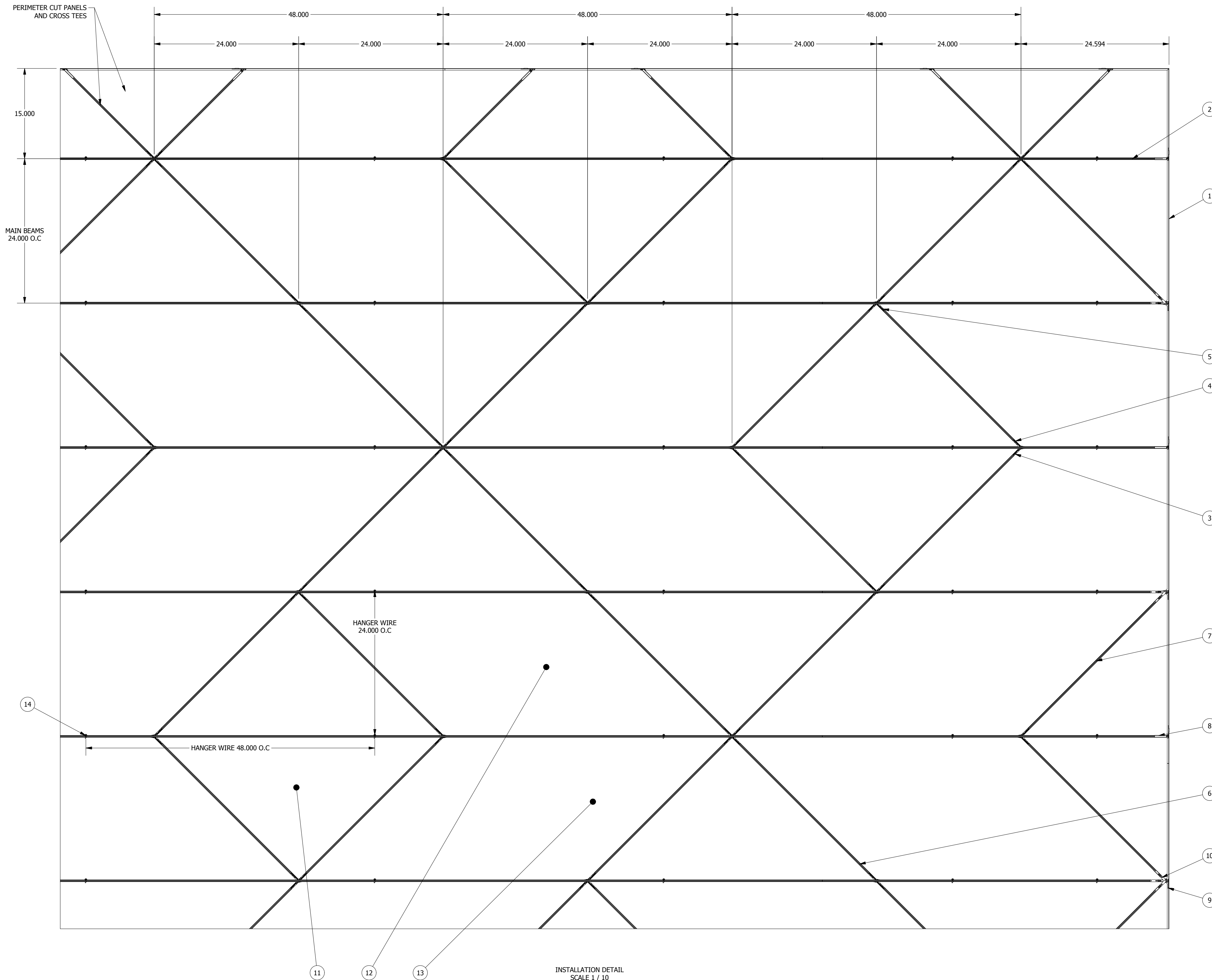

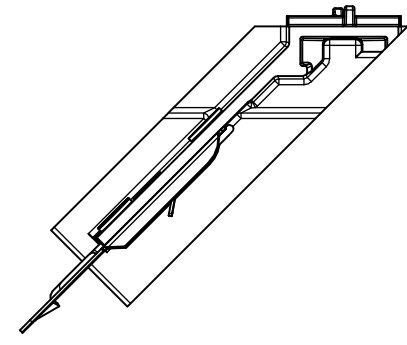

BP75AB45L Suprafine
45° Left Angle Bracket

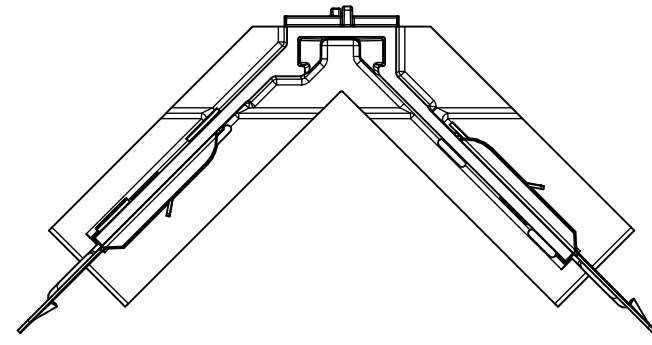

BP75AB45D Suprafine
45° Double Angle Bracket

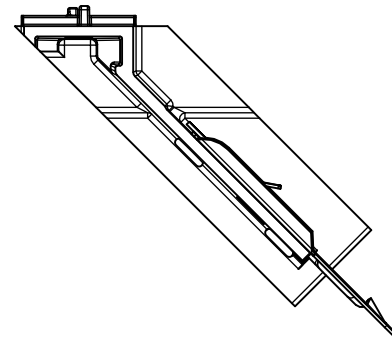

BP75AB45R Suprafine
45° Right Angle Bracket

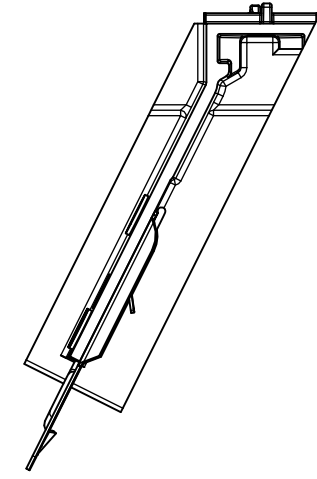

BP75AB60L Suprafine
60° Left Angle Bracket

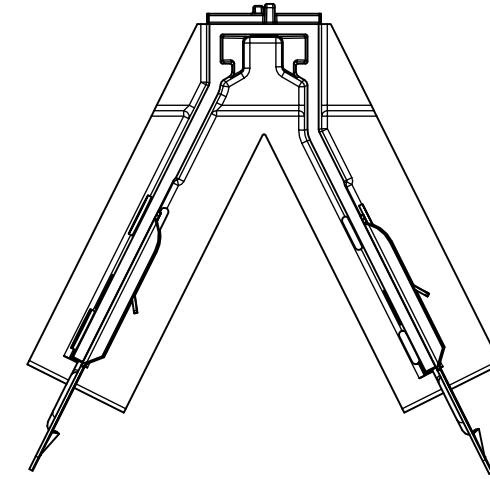

BP75AB60D Suprafine
60° Double Angle Bracket

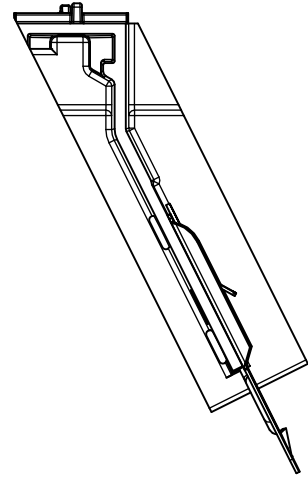

BP75AB60R Suprafine
60° Right Angle Bracket

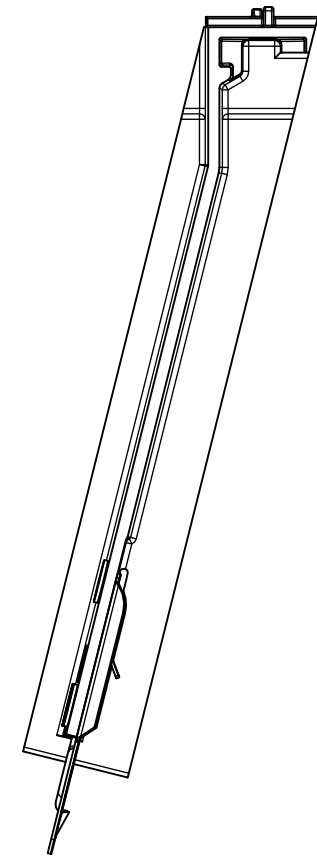

BP75AB75L Suprafine
75° Left Angle Bracket

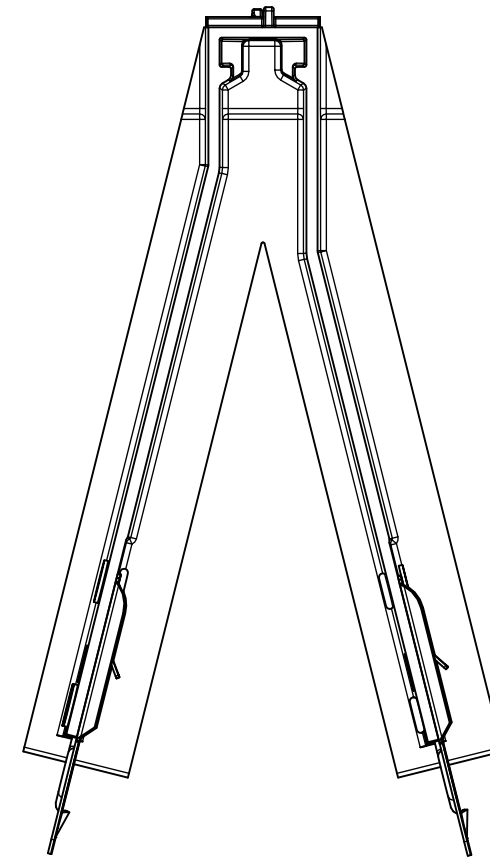

BP75AB75D Suprafine
75° Double Angle Bracket

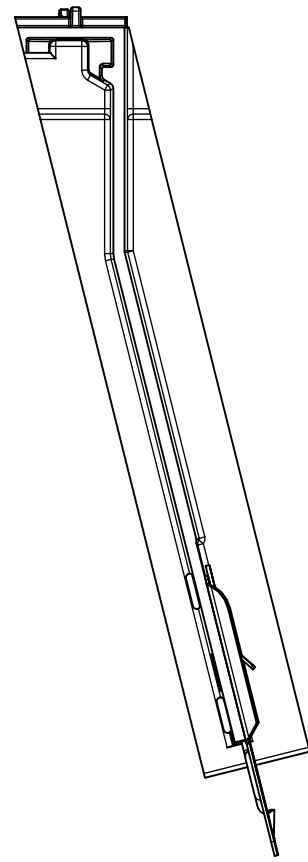

BP75AB75R Suprafine
75° Right Angle Bracket

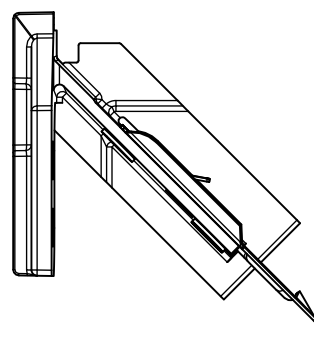

BP75CB45 Suprafine
45° Corner Bracket

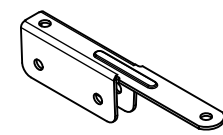

BPPAC
Perimeter Angle Clip
SCALE 1 / 2

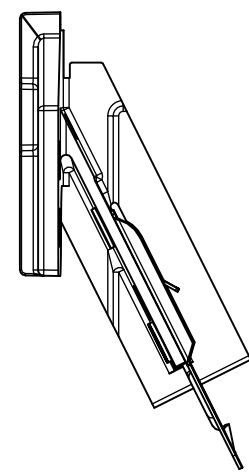

BP75CB60L Suprafine
60° Left Corner Bracket

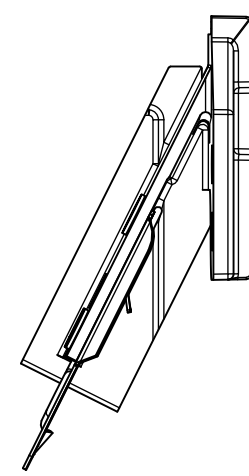

BP75CB60R Suprafine
60° Right Corner Bracket

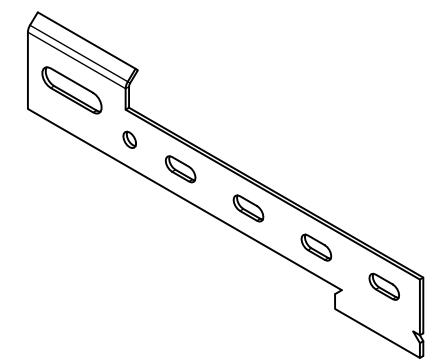

BPPCC
Axiom Perimeter Corner Clip
SCALE 1 / 2

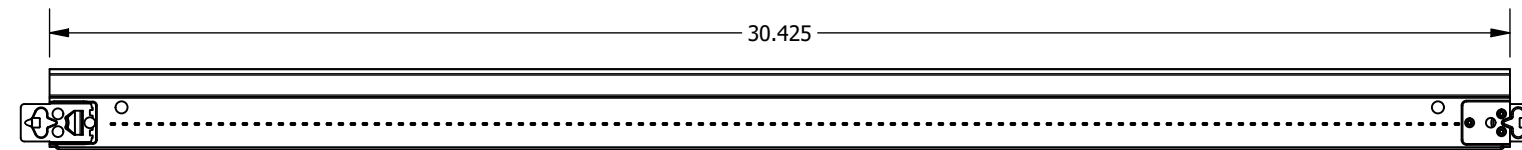

BPXM754524 Suprafine
45° Cross Tee - 24\"/>

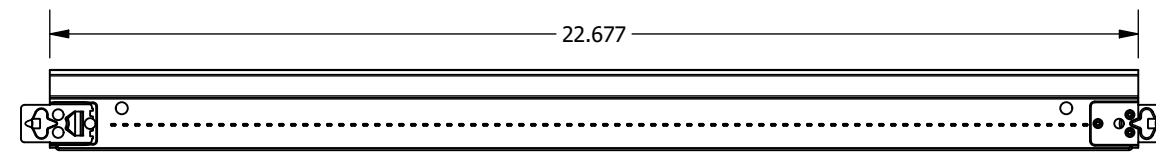

BPXM756024 Suprafine
60° Cross Tee - 24\"/>

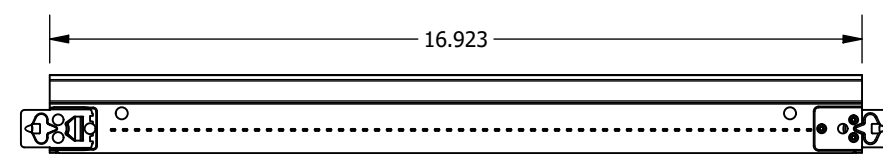

BPXM757524 Suprafine
75° Cross Tee - 24\"/>

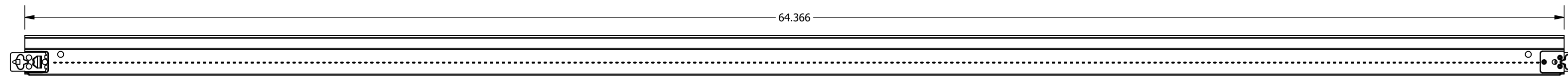

BPXM754548 Suprafine
45° Cross Tee - 48\"/>

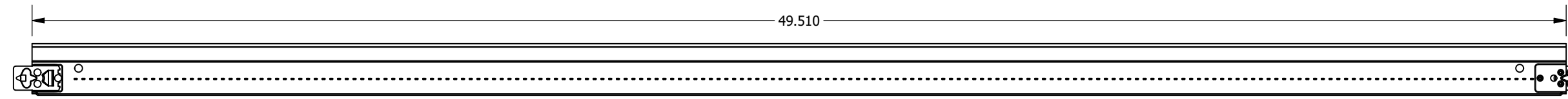

BPXM756048 Suprafine
60° Cross Tee - 48\"/>

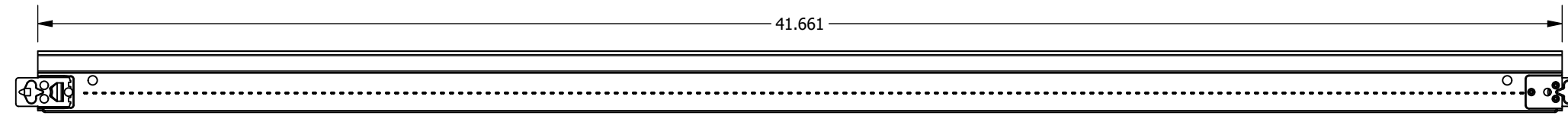

BPXM757548 Suprafine
75° Cross Tee - 48\"/>

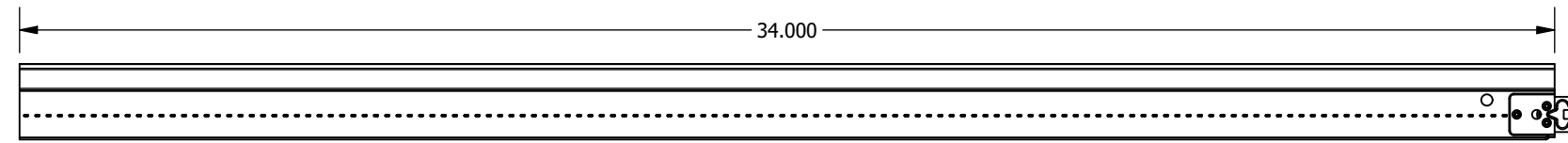

BPXM7524 Suprafine
Perimeter Cross Tee - 24\"/>

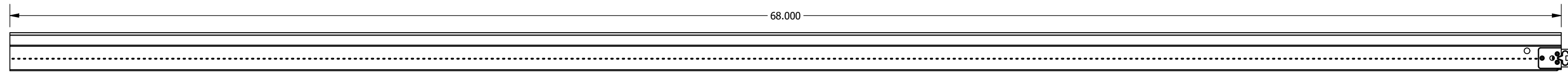

BPXM7548 Suprafine
Perimeter Cross Tee - 48\"/>

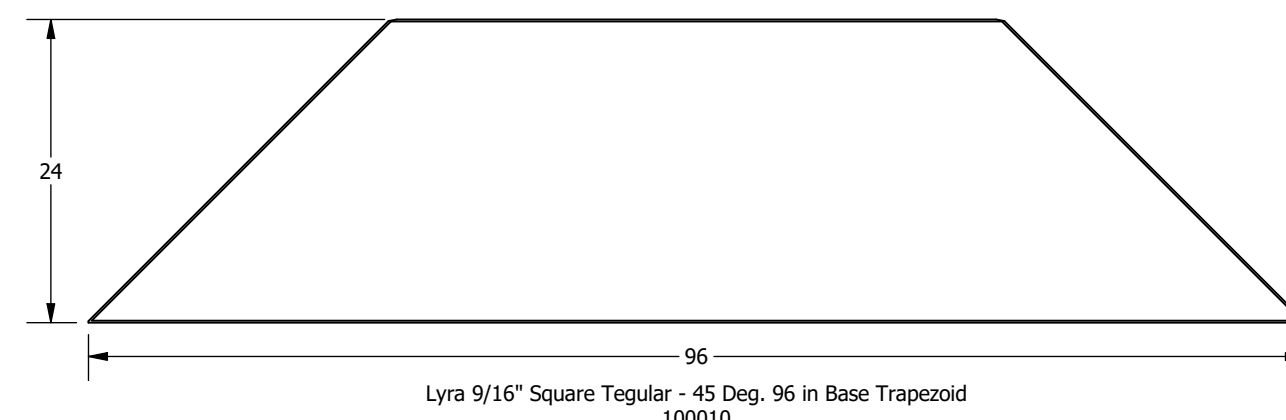
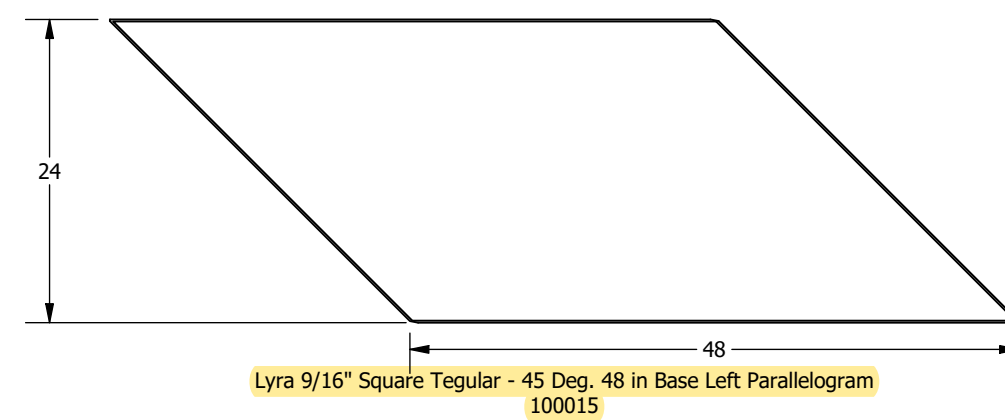
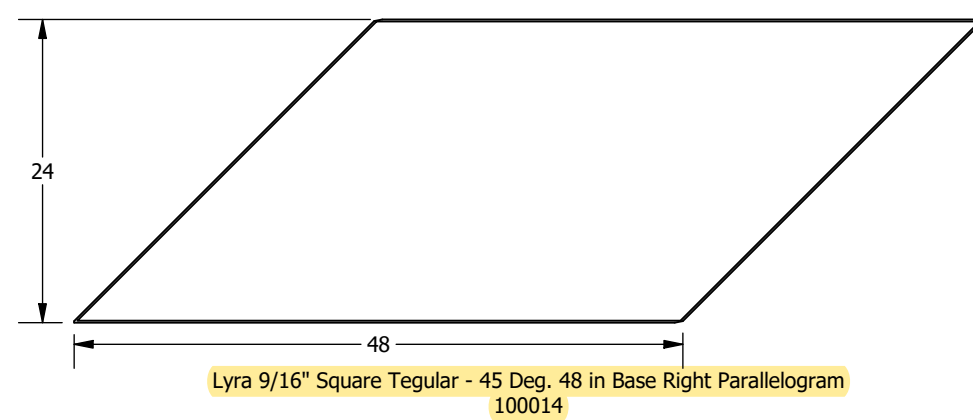
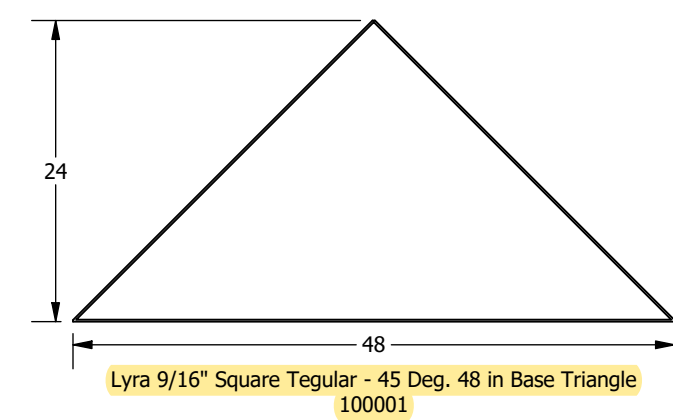
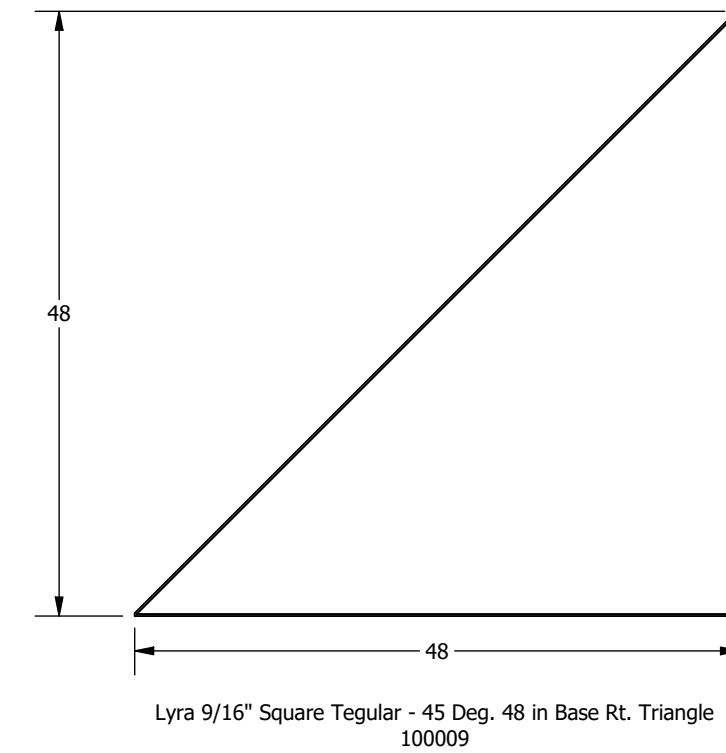
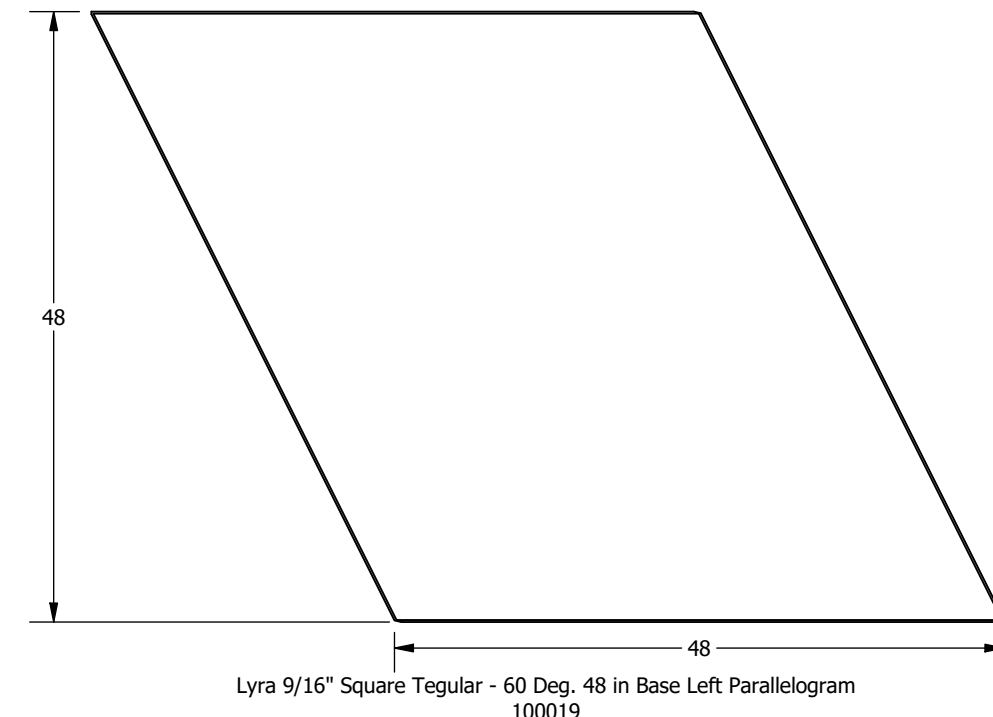
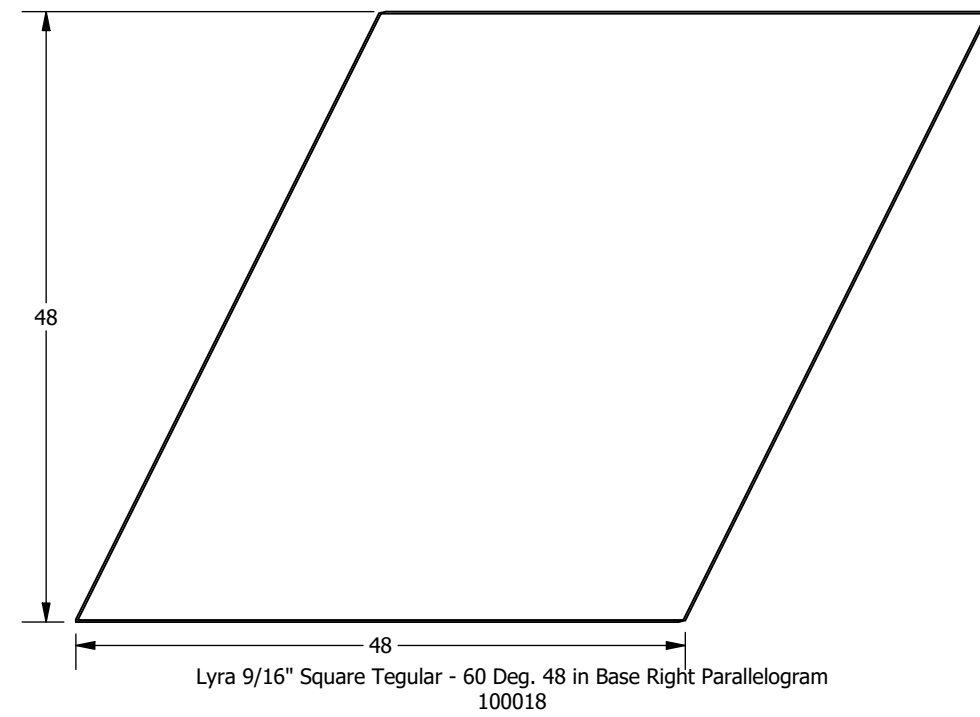
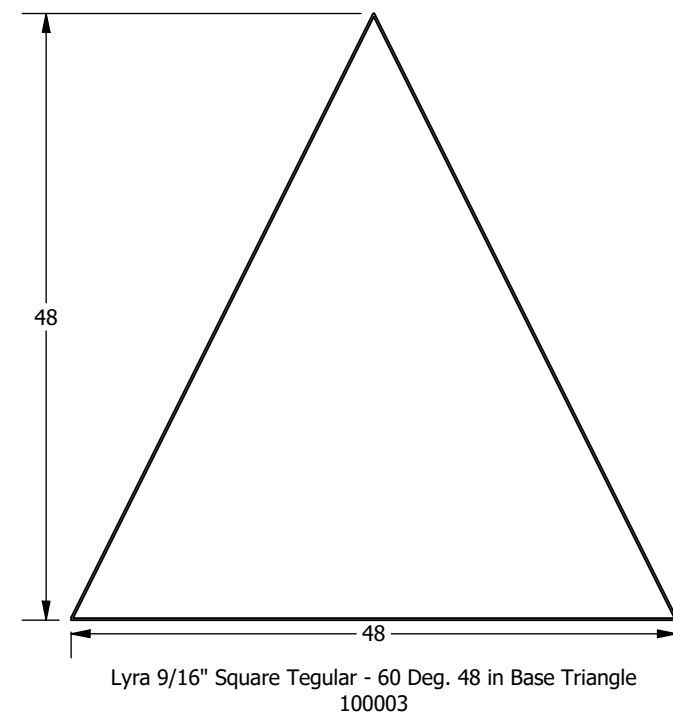
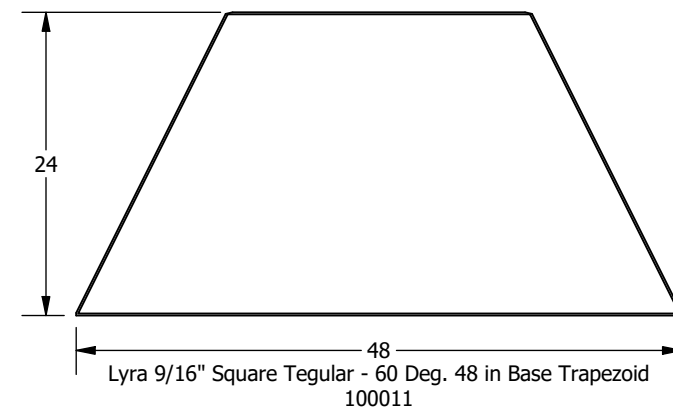
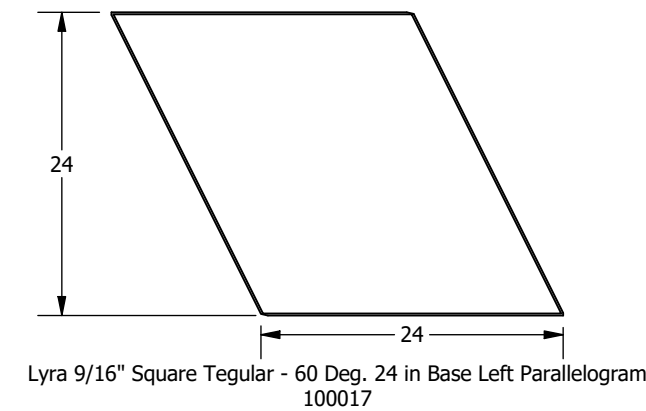
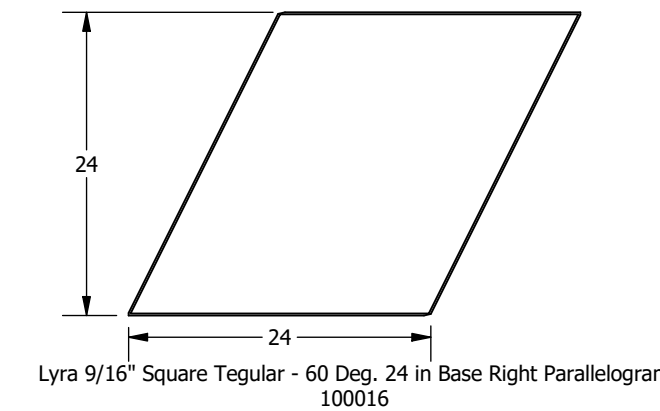
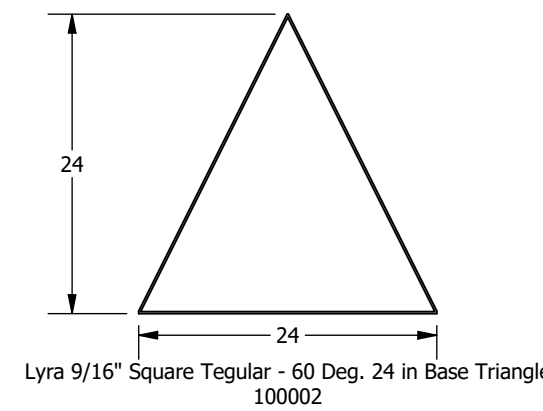
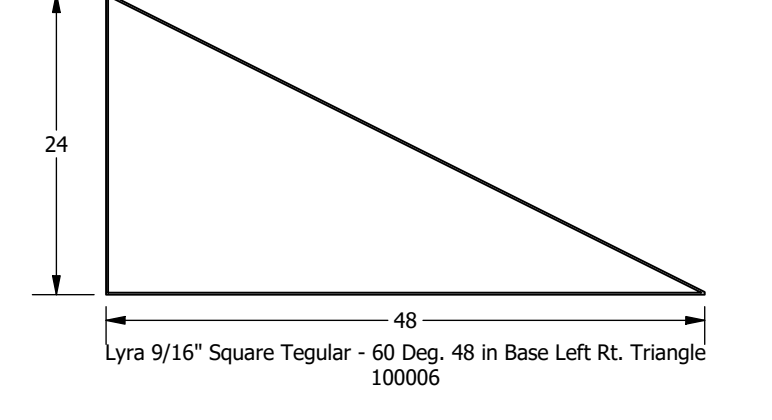
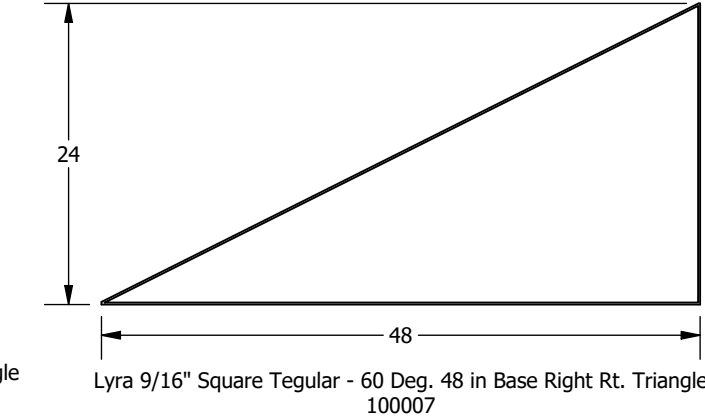
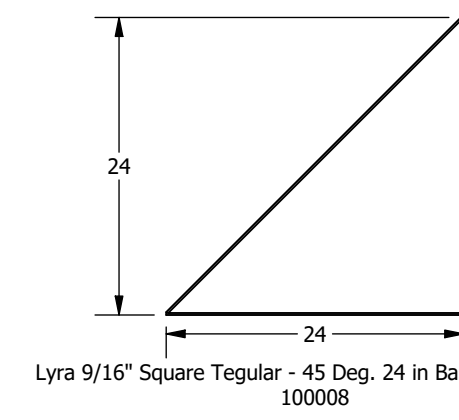
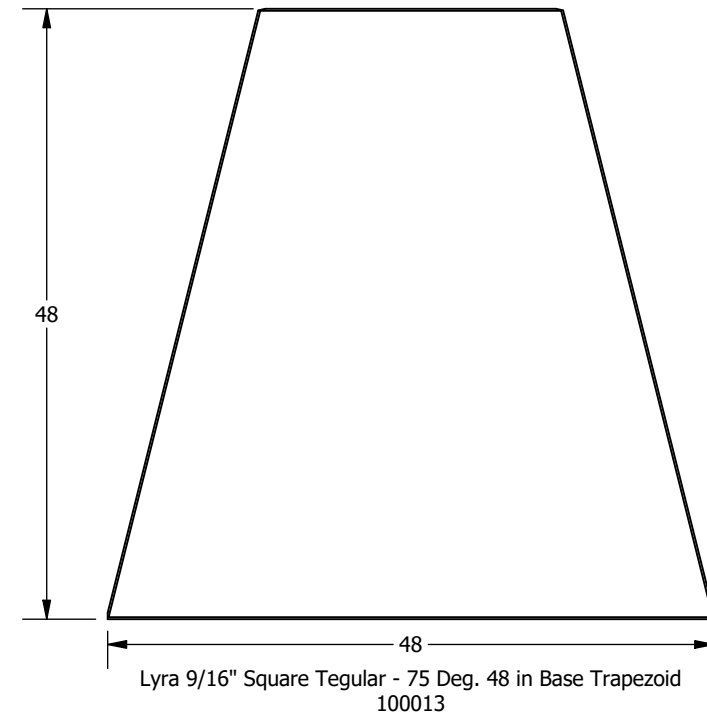
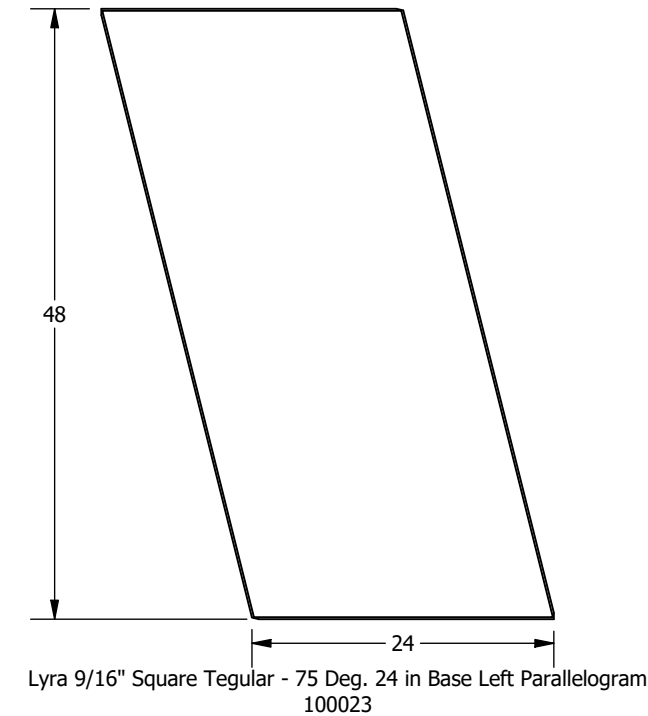
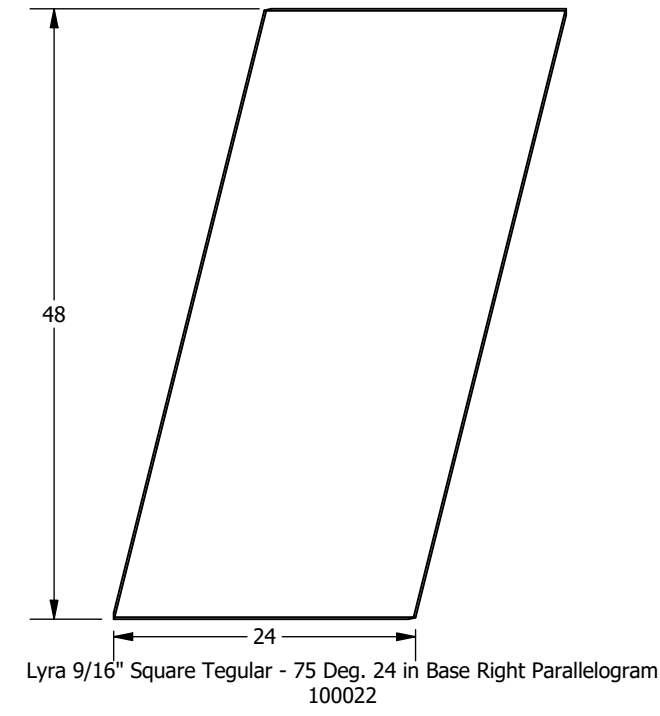
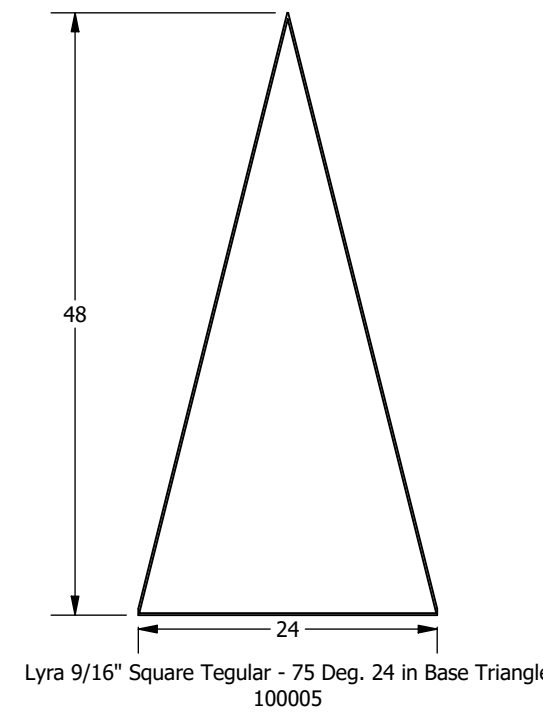
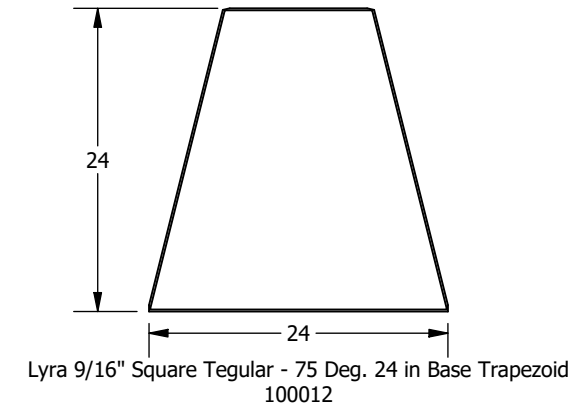
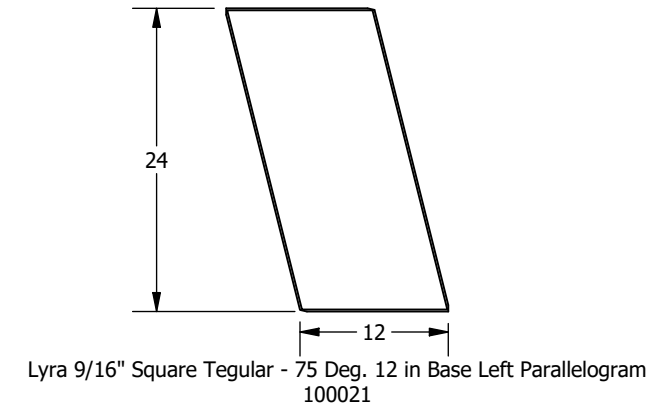
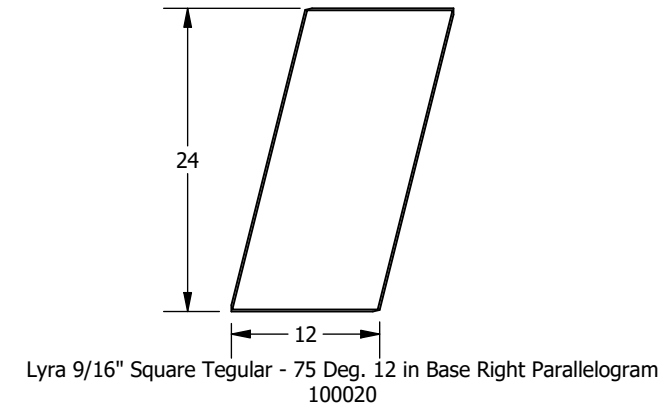
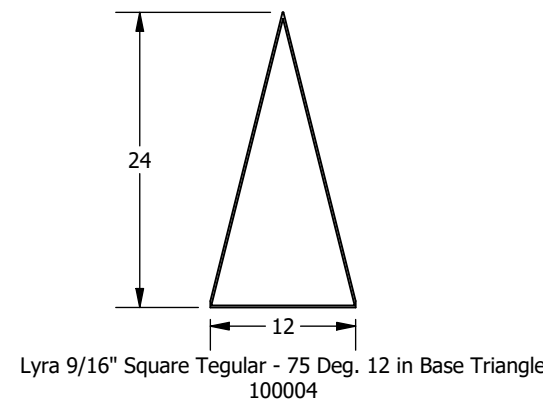

NOTES:
 1. Views are from the face of the panel, and descriptions are based on these views
 2. Dimensions are nominal and reflect grid spacings
 3. Scale 1:15

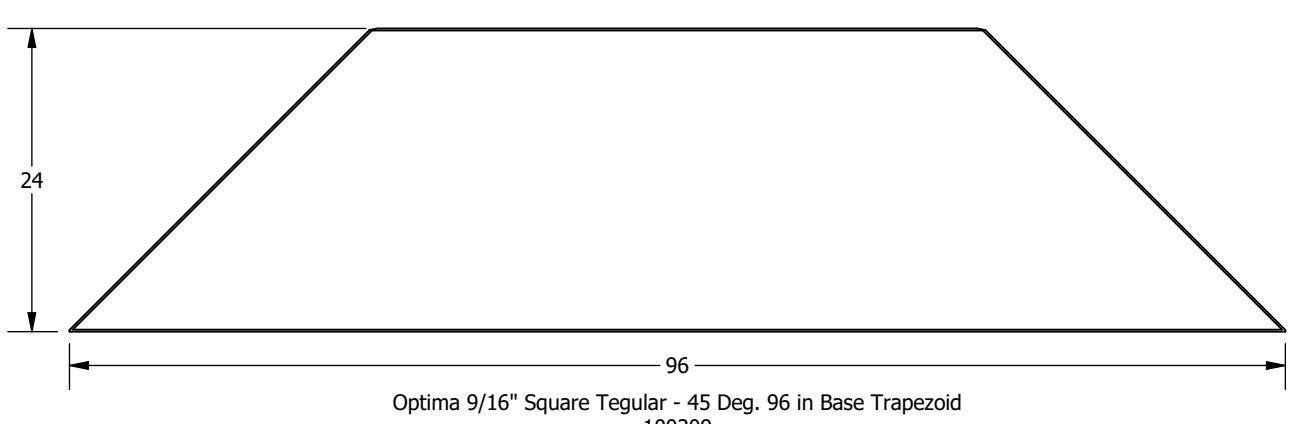
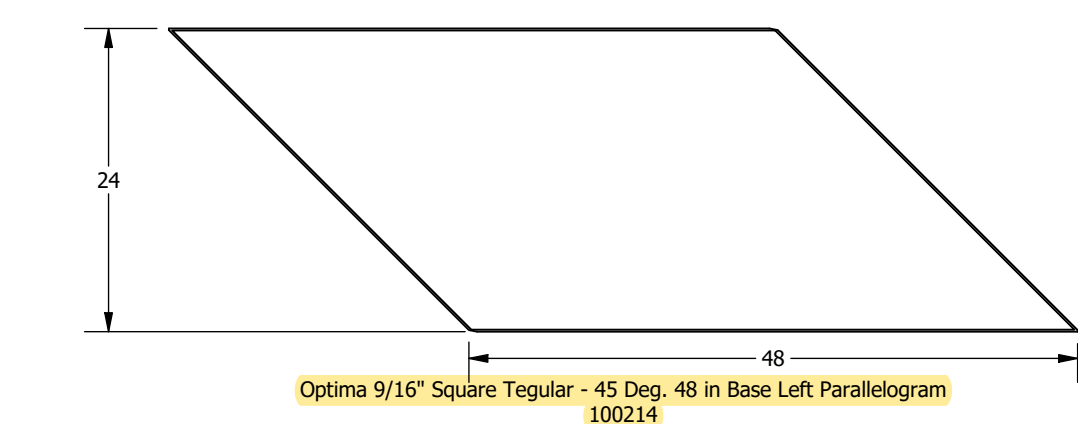
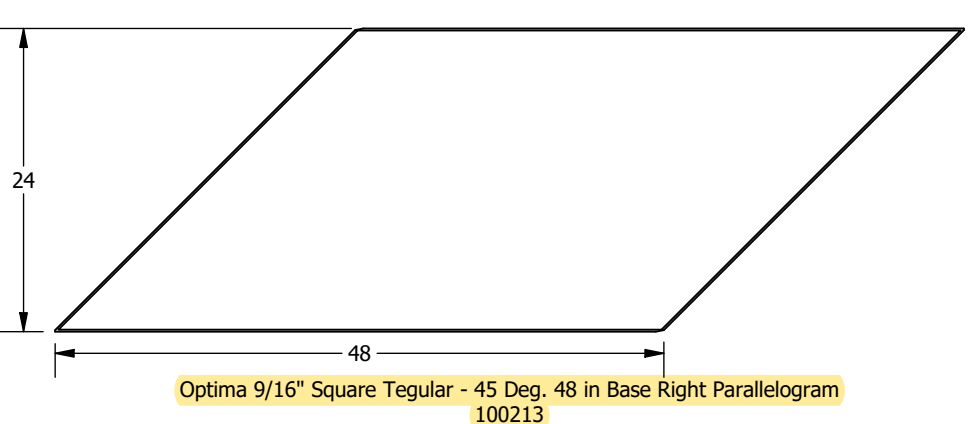
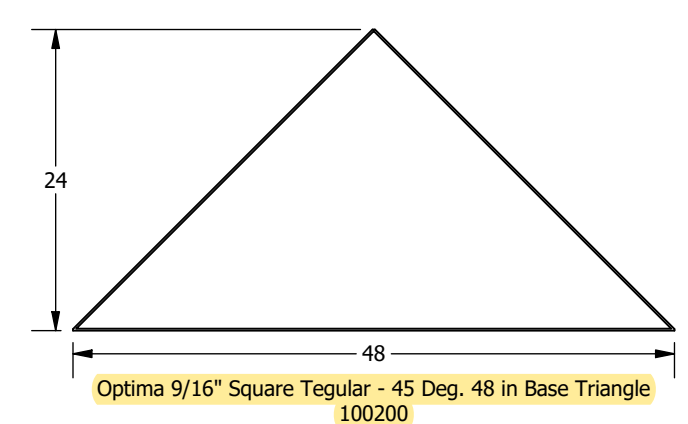
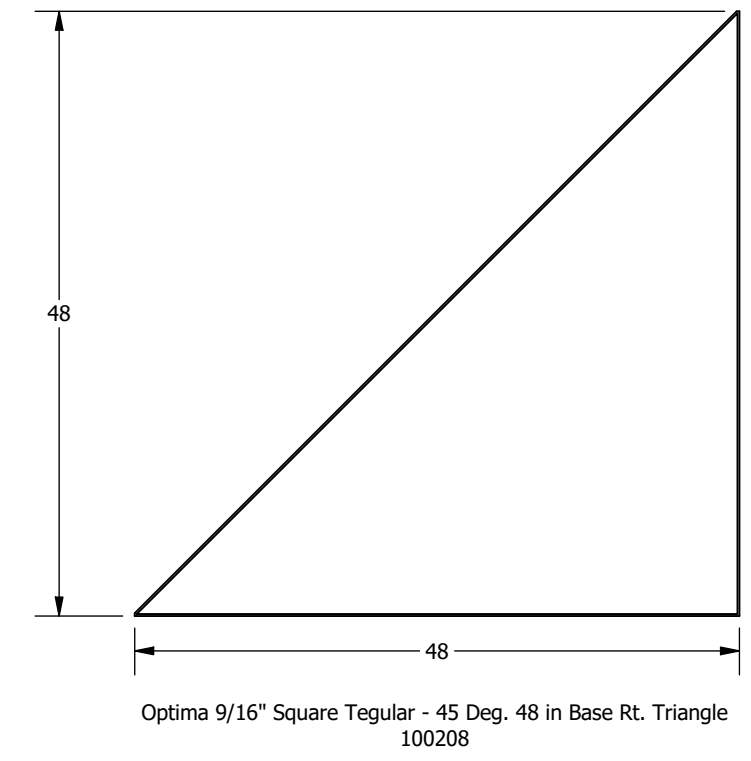
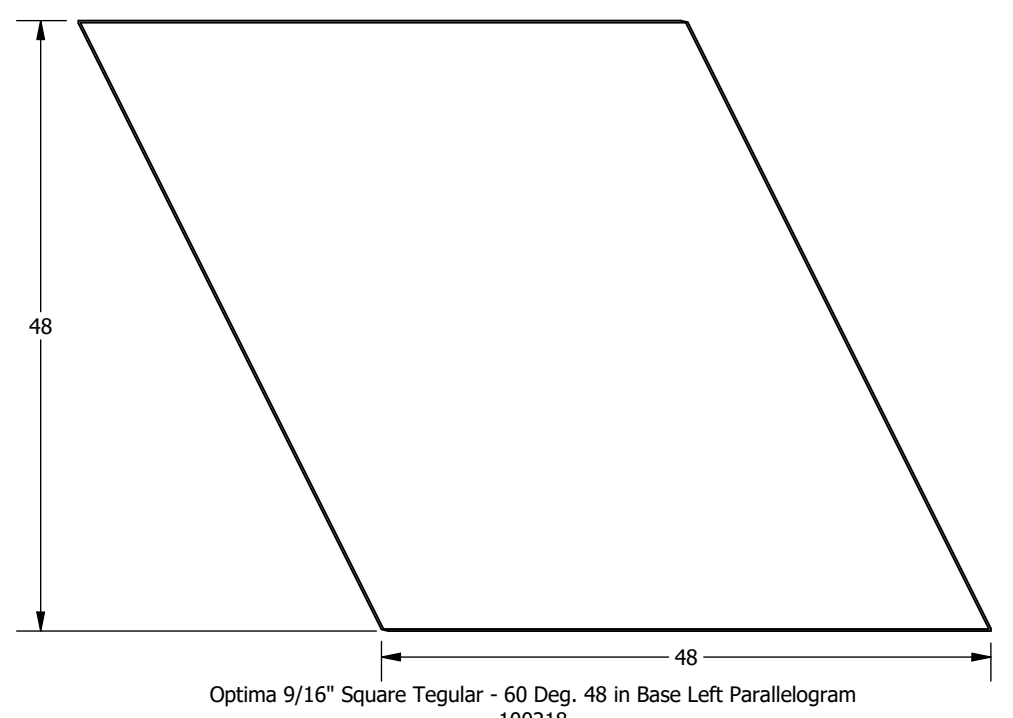
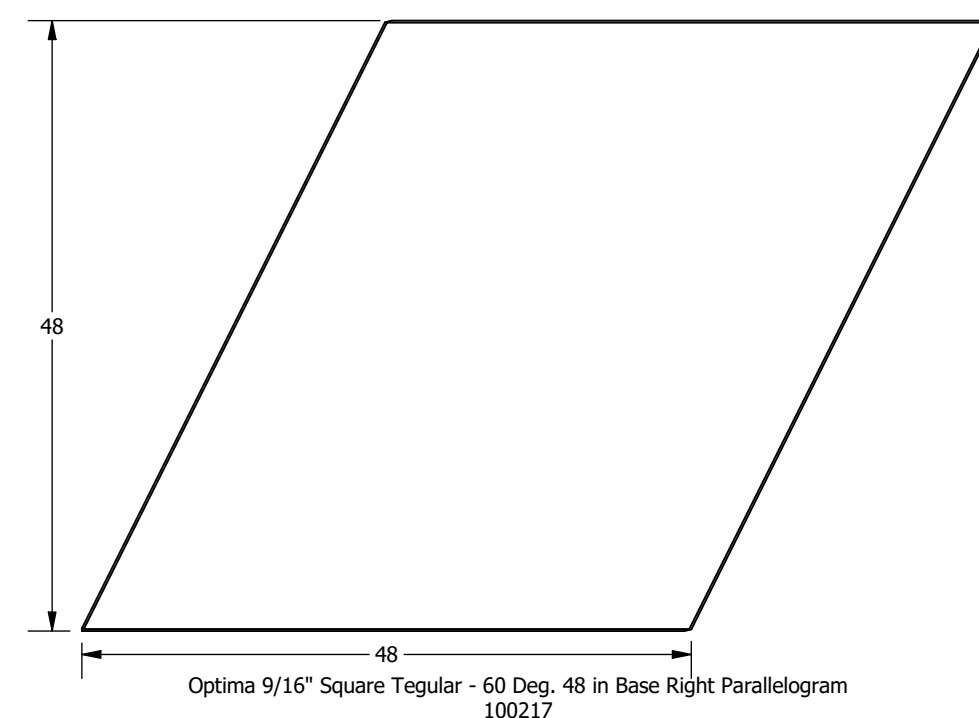
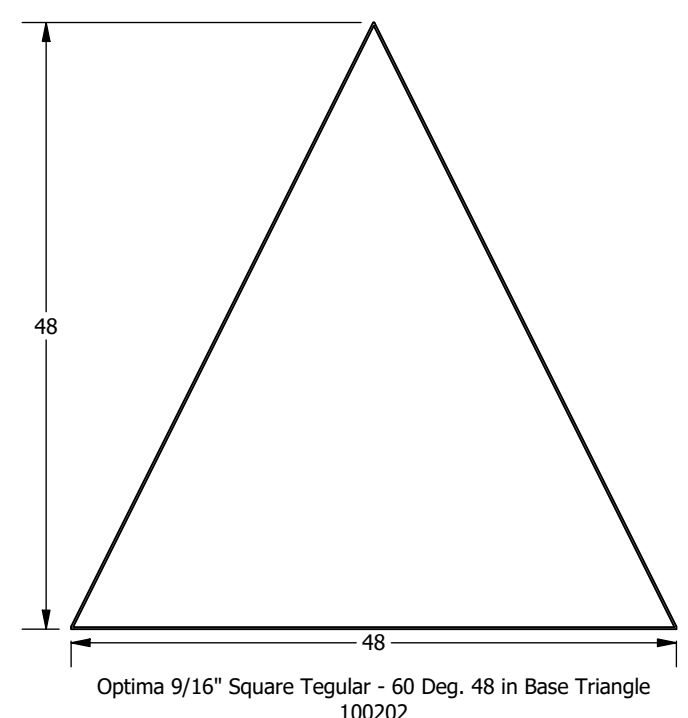
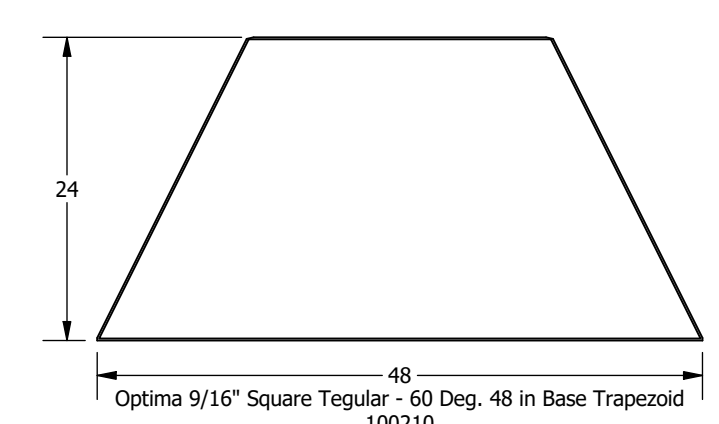
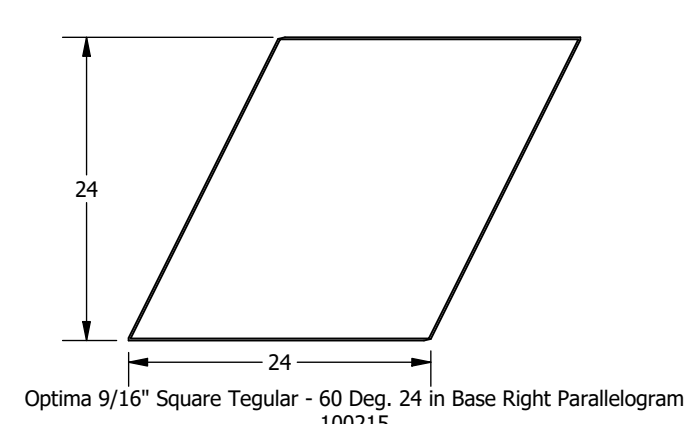
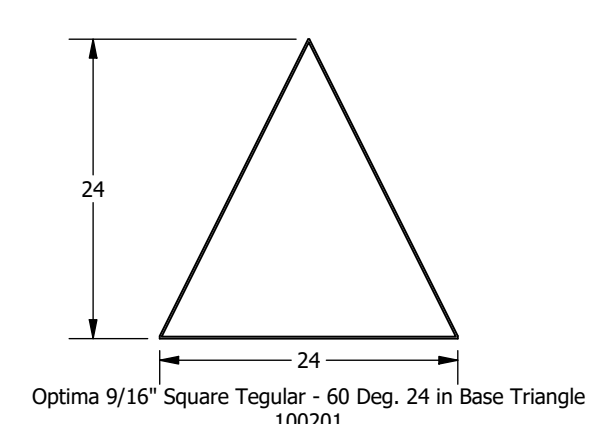
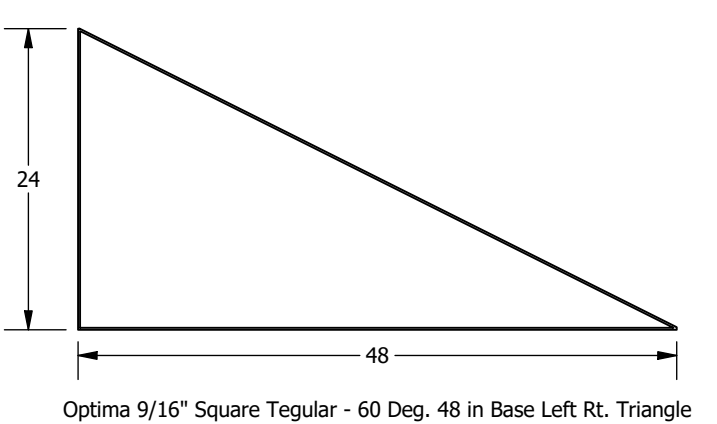
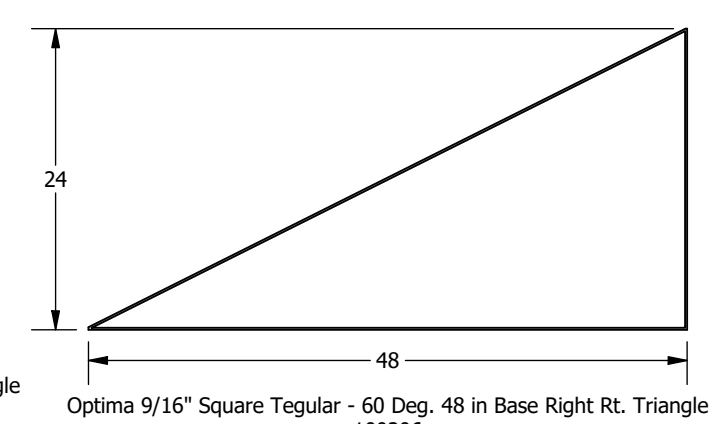
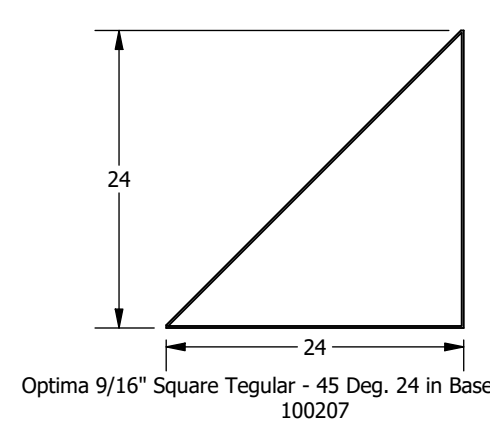
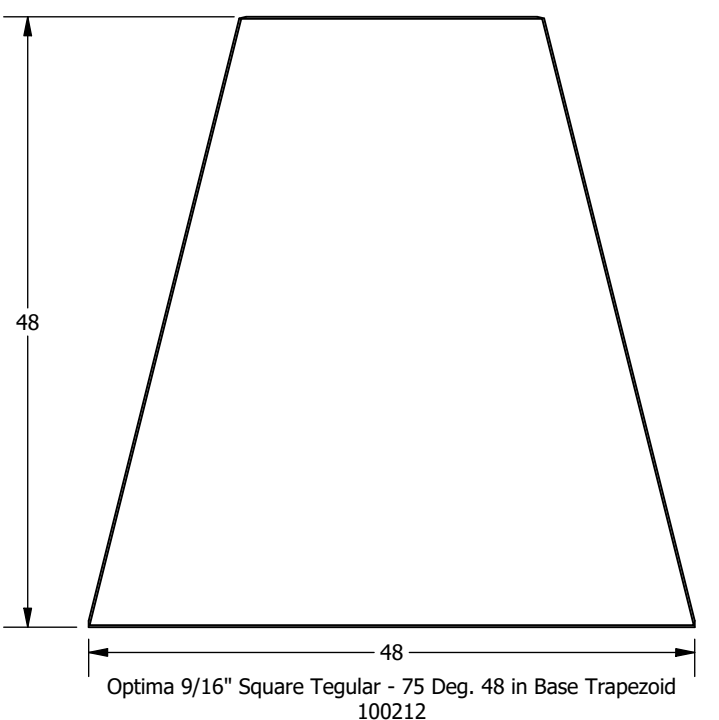
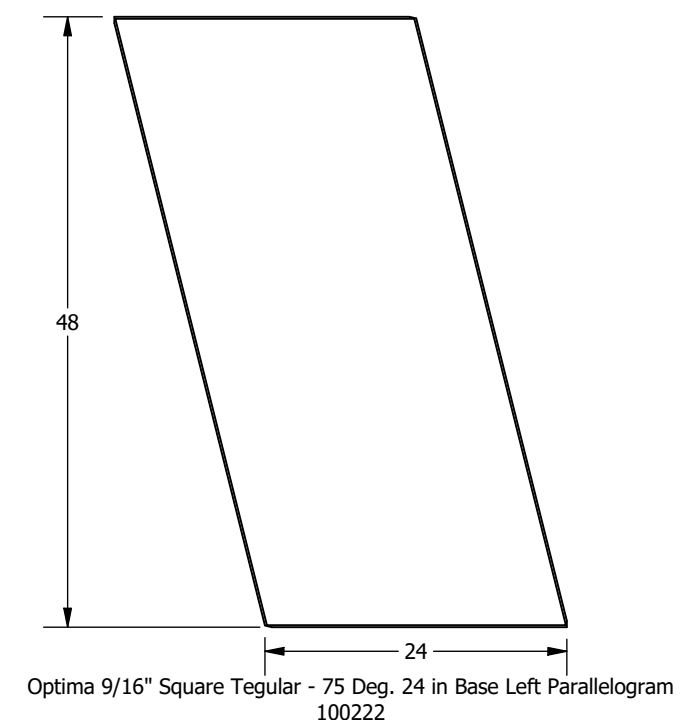
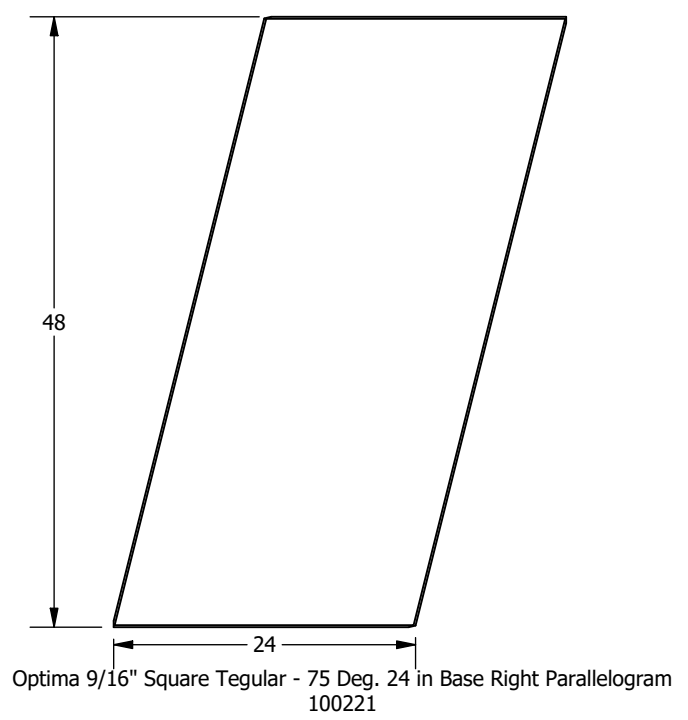
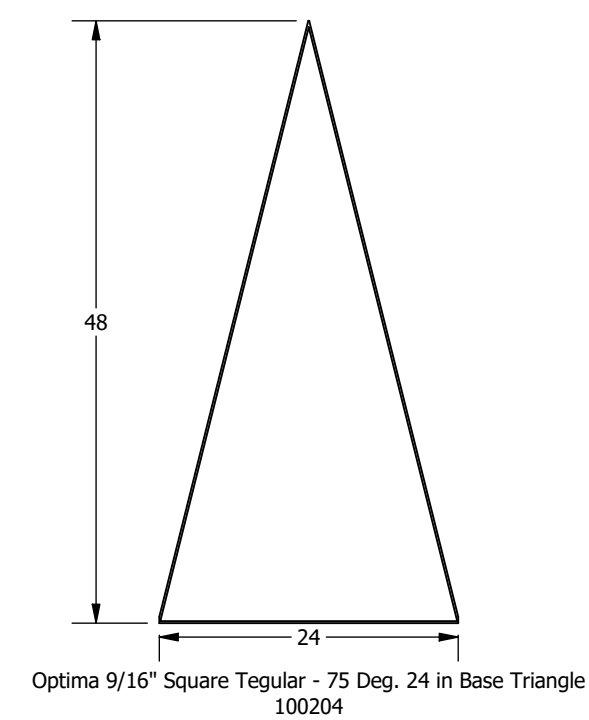
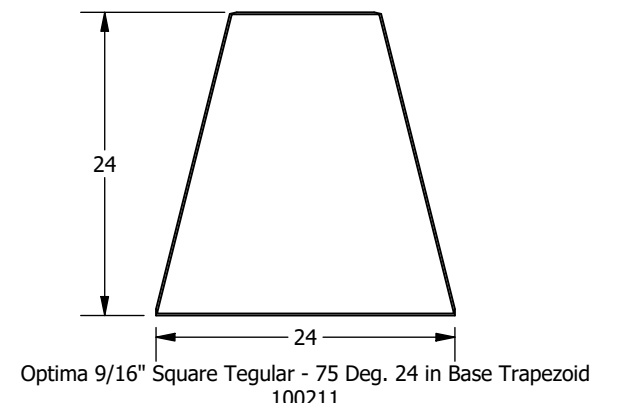
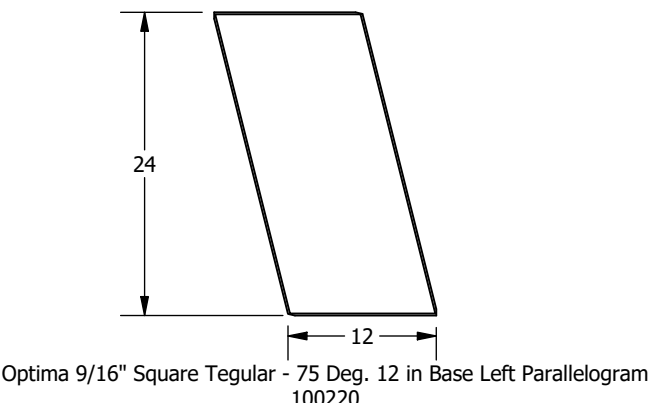
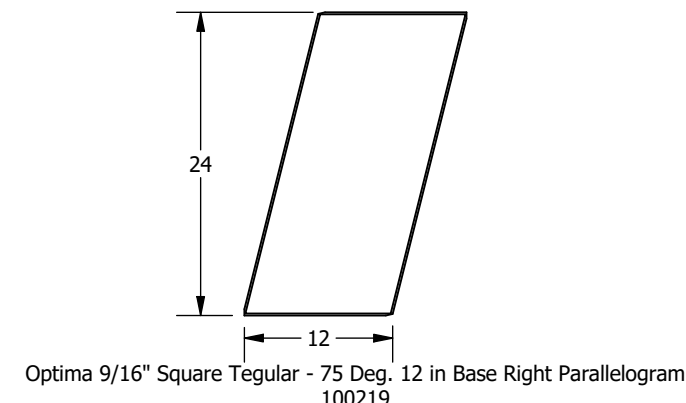
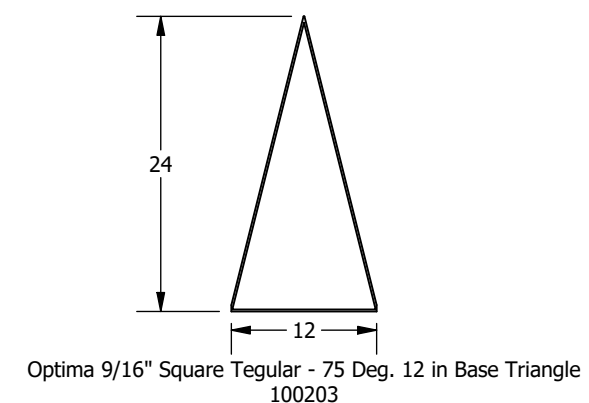

NOTES:
1. Views are from the face of the panel, and descriptions are based on these views
2. Dimensions are nominal and reflect grid spacings
3. Scale 1:15

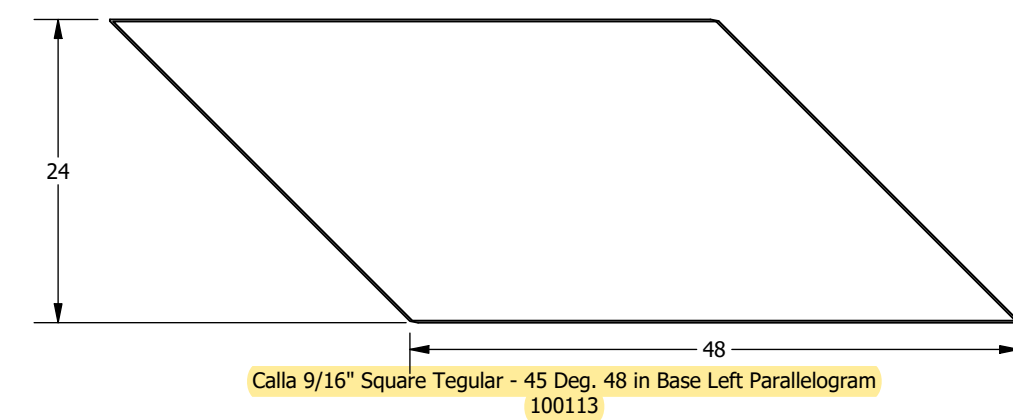
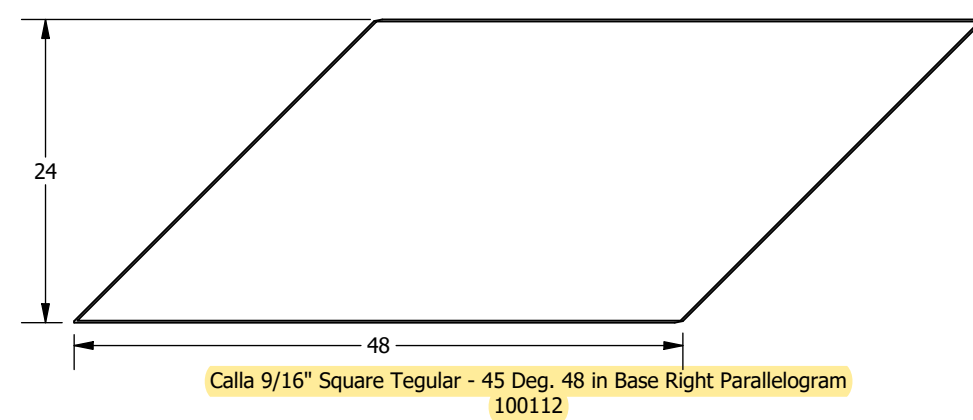
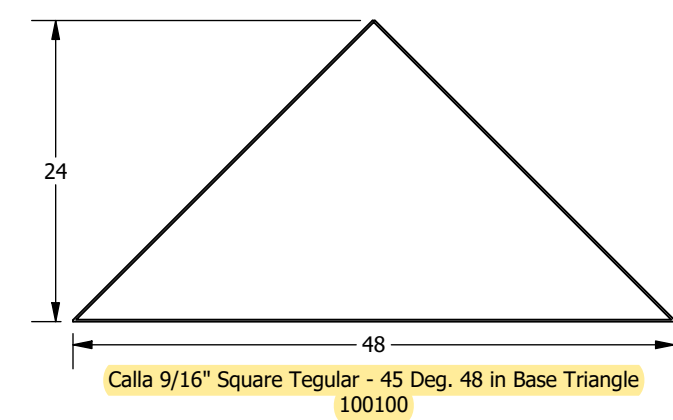
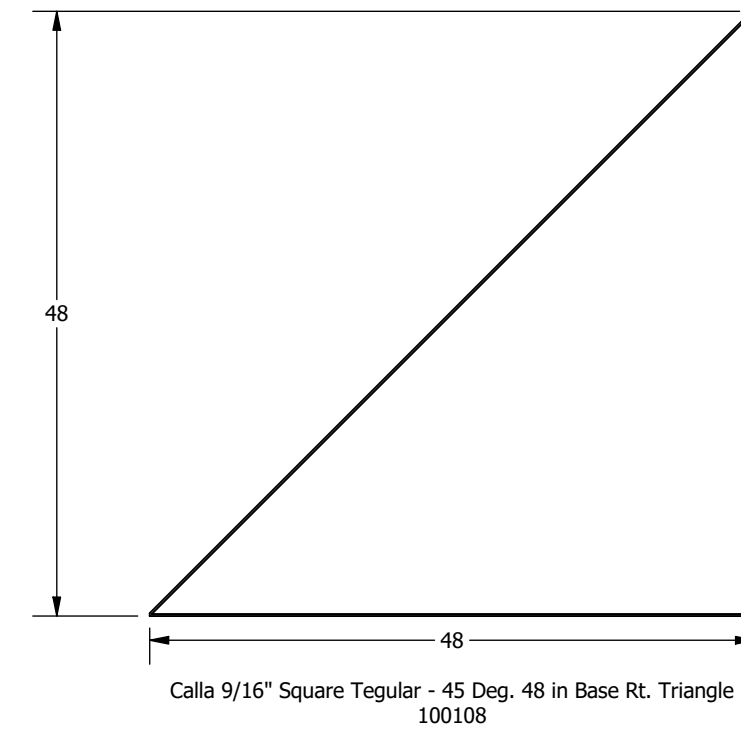
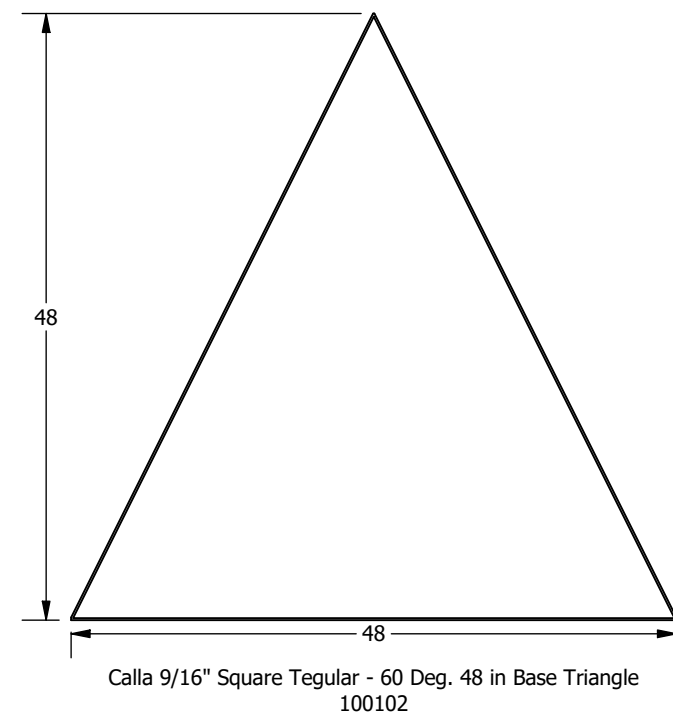
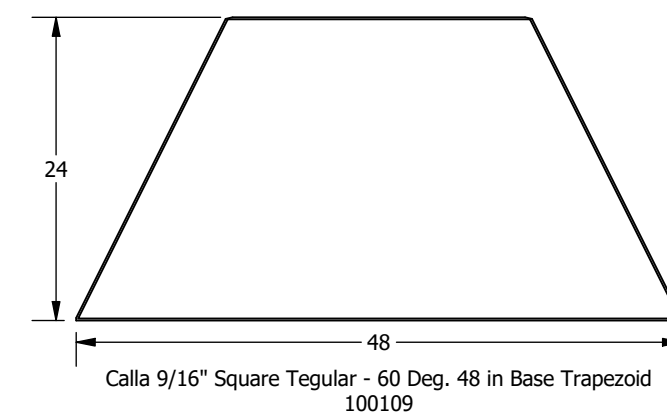
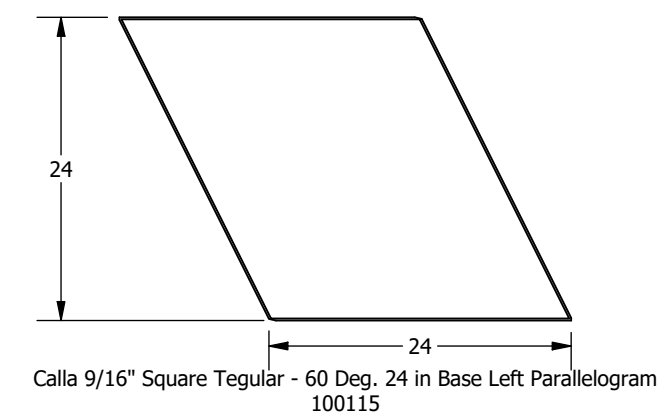
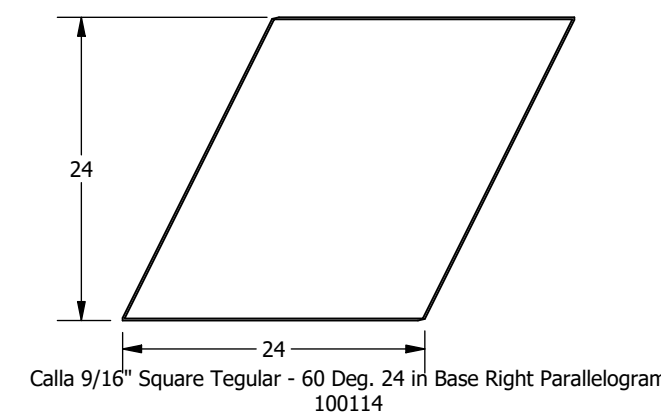
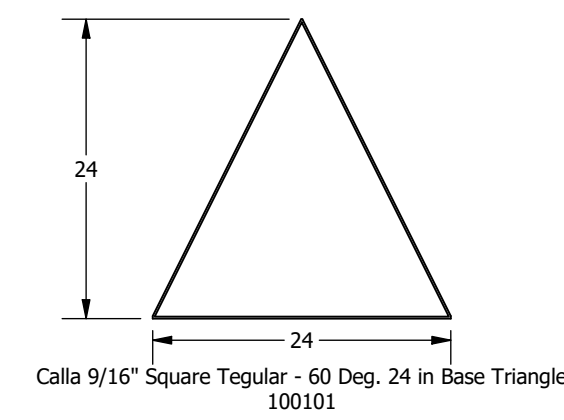
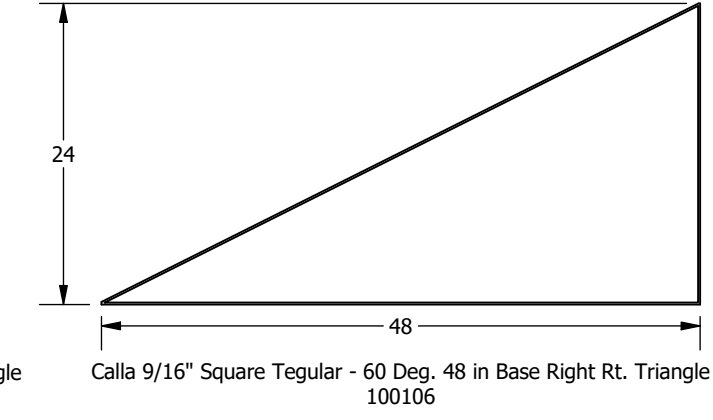
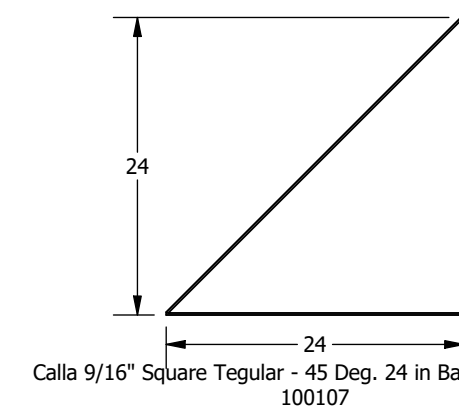
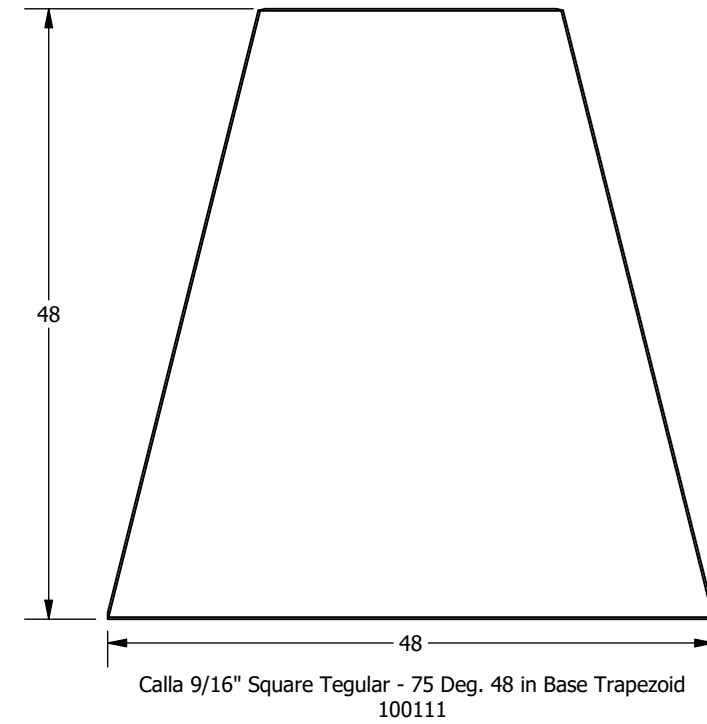
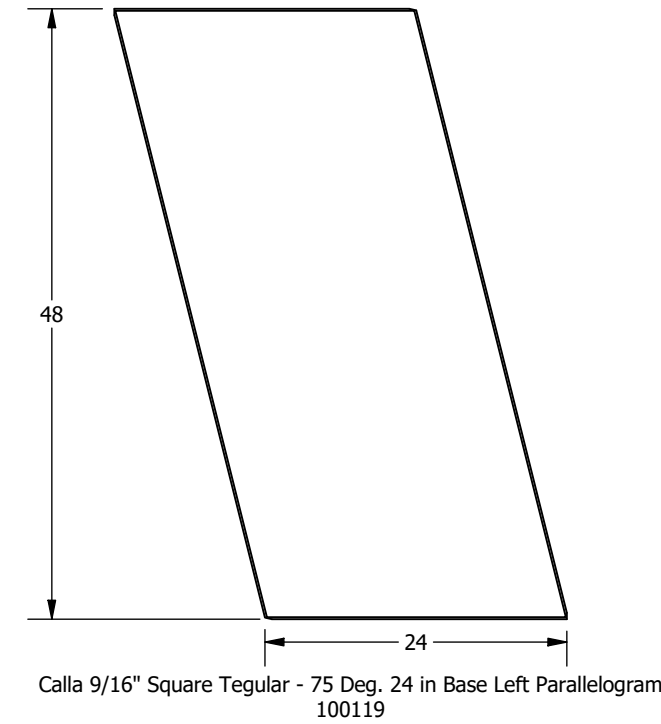
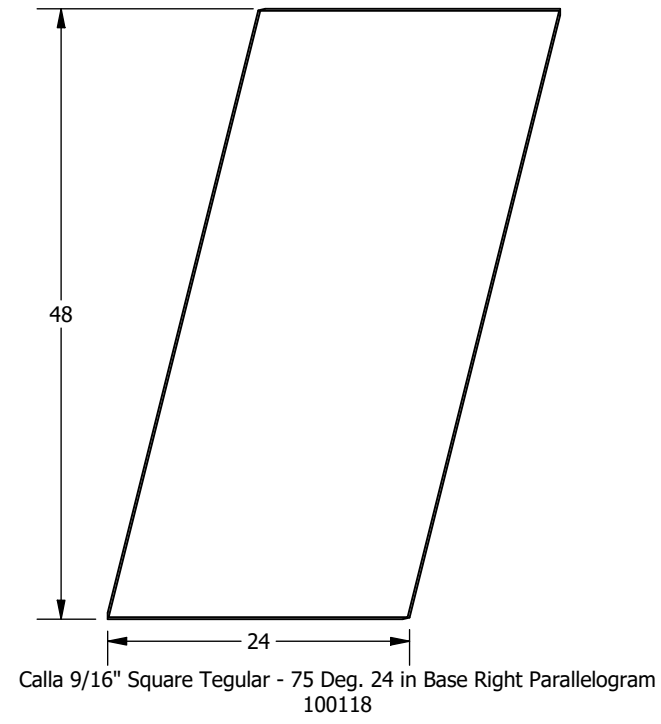
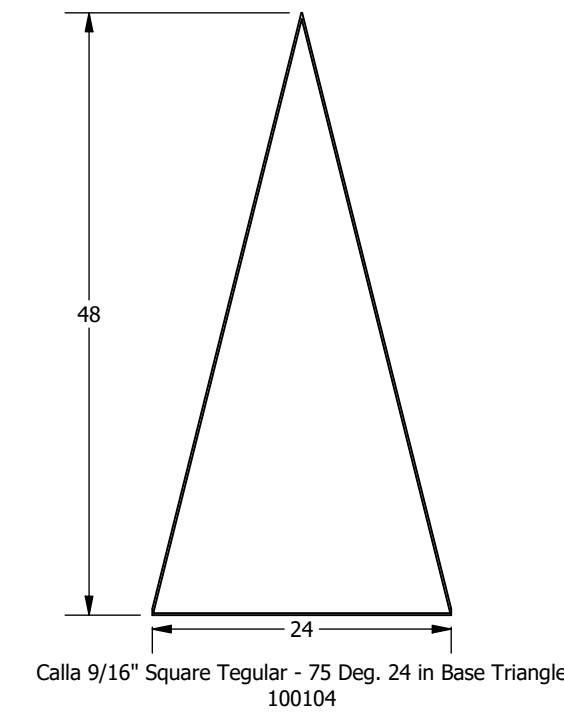
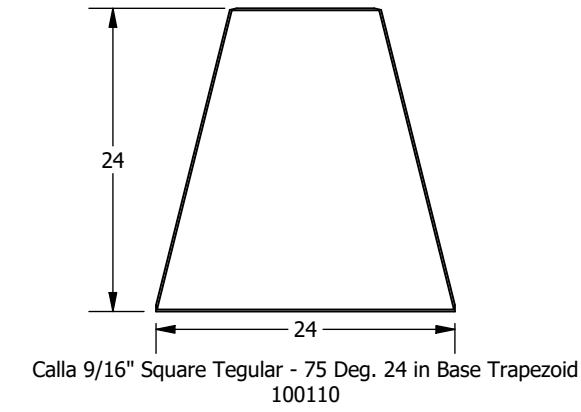
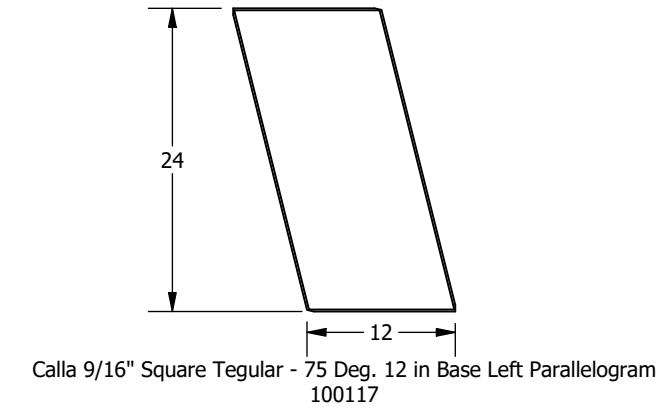
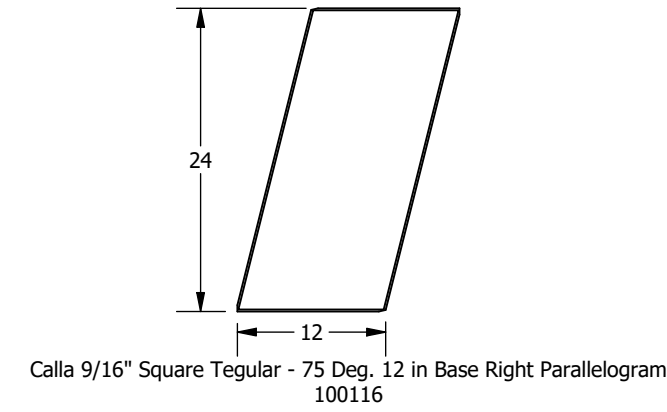
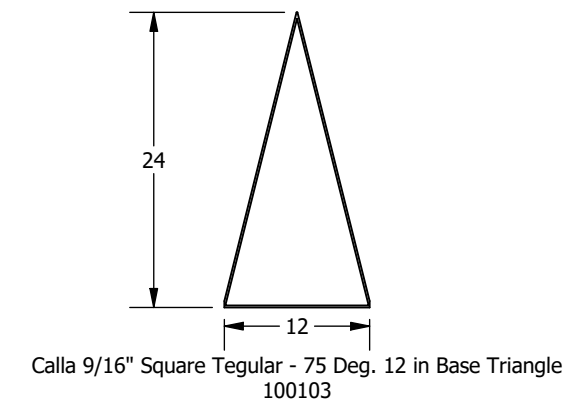

NOTES:
1. Views are from the face of the panel, and descriptions are based on these views
2. Dimensions are nominal and reflect grid spacings
3. Scale 1:15

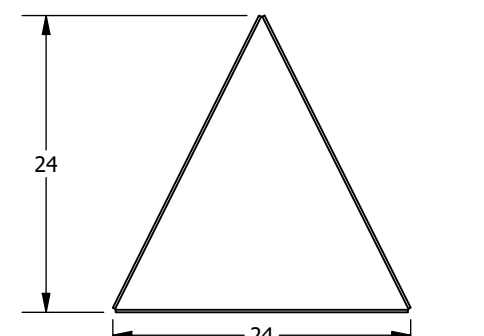

MetalWorks Tegular Triangle 60 Deg. 24 in Base
8290-M1

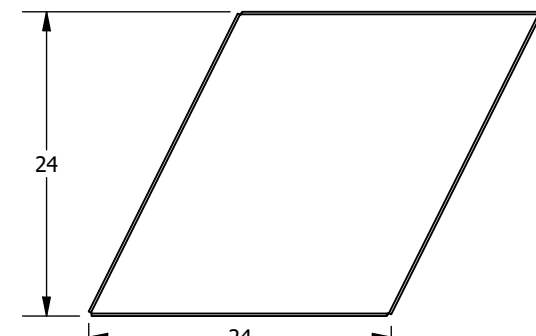

MetalWorks Tegular Parallelogram - Right 60 Deg. 24 in Base
8292-M1

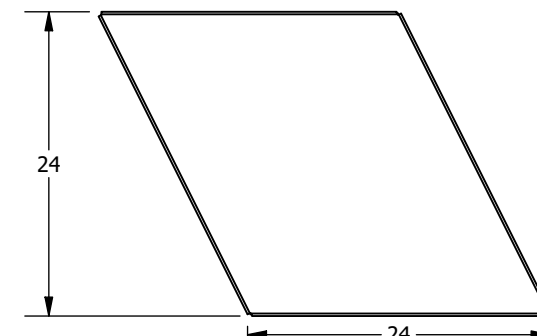

MetalWorks Tegular Parallelogram - Left 60 Deg. 24 in Base
8293-M1

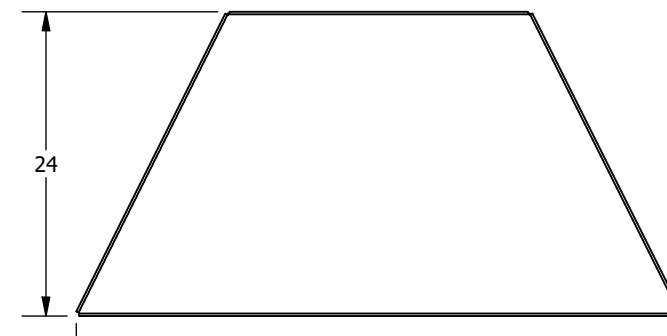

MetalWorks Tegular Trapezoid 60 Deg. 48 in Base
8296-M1

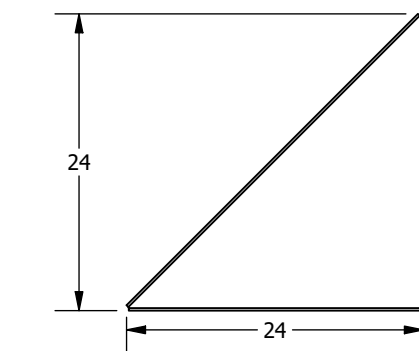

MetalWorks Tegular Rt. Triangle 45 Deg. 24 in Base
8285-M1

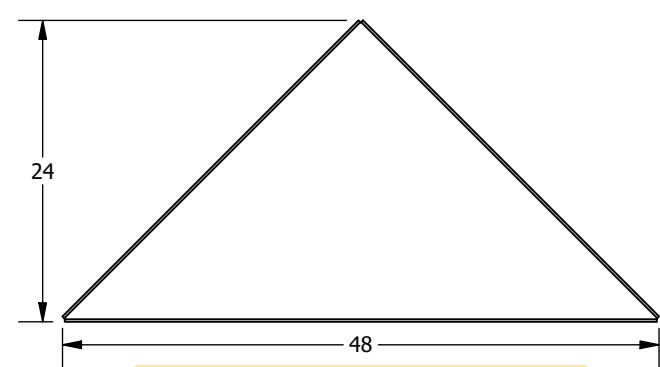

MetalWorks Tegular Triangle 45 Deg. 48 in Base
8284-M1

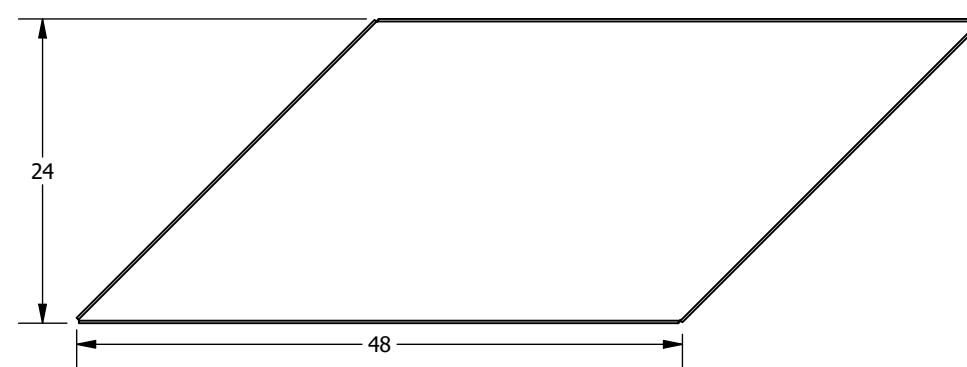

MetalWorks Tegular Parallelogram - Right 45 Deg. 48 in Base
8287-M1

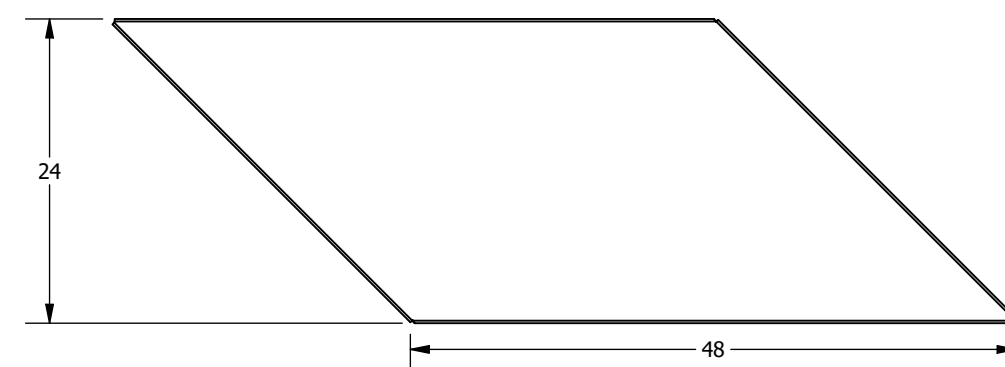

MetalWorks Tegular Parallelogram - Left 45 Deg. 48 in Base
8288-M1

NOTES:
1. Views are from the face of the panel, and descriptions are based on these views
2. Dimensions are nominal and reflect grid spacings
3. Scale 1:15

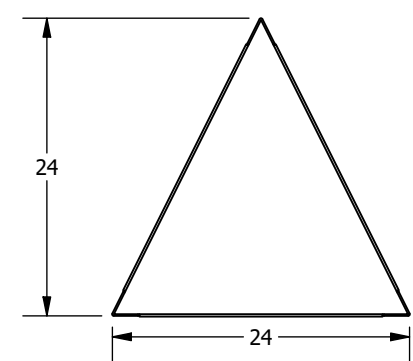

WoodWorks Tegular - 60 Deg. 24 in. Base Triangle
8277-W1

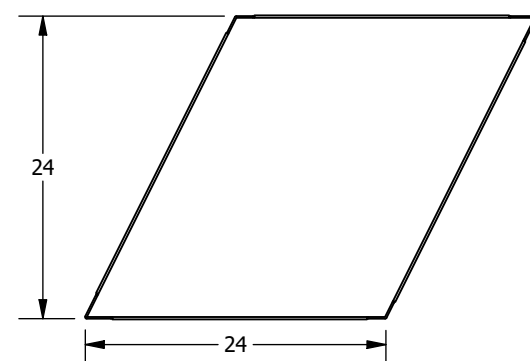

WoodWorks Tegular - 60 Deg. 24 in. Base Right Parallelogram
8279-W1

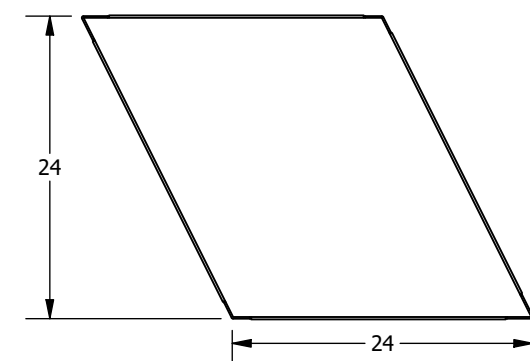

WoodWorks Tegular - 60 Deg. 24 in. Base Left Parallelogram
8280-W1

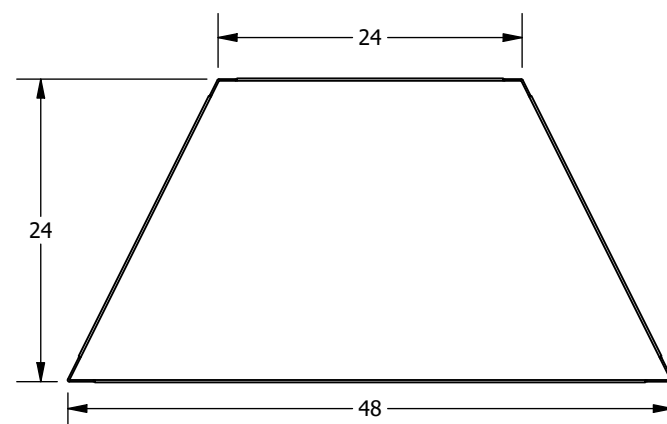

WoodWorks Tegular - 60 Deg. 48 in. Base Trapezoid
8281-W1

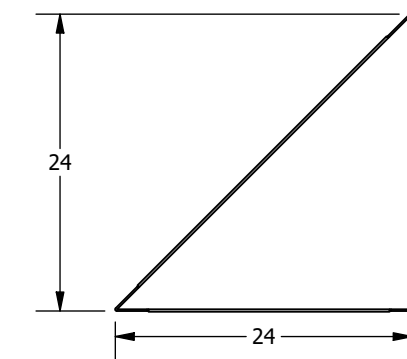

WoodWorks Tegular - 45 Deg. 24 in. Base Right Rt. Triangle
8272-W1

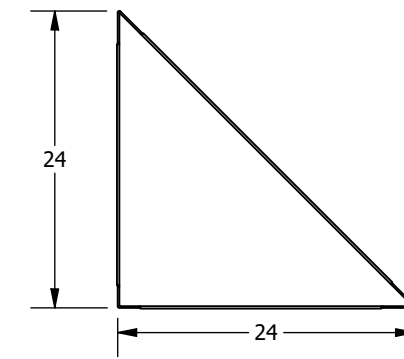

WoodWorks Tegular - 45 Deg. 24 in. Base Left Rt. Triangle
8282-W1

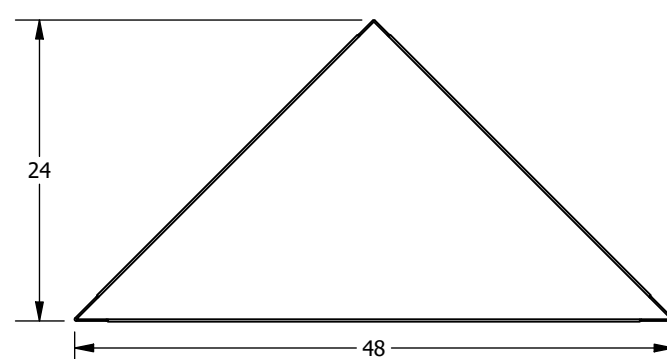

WoodWorks Tegular - 45 Deg. 48 in. Base Triangle
8271-W1

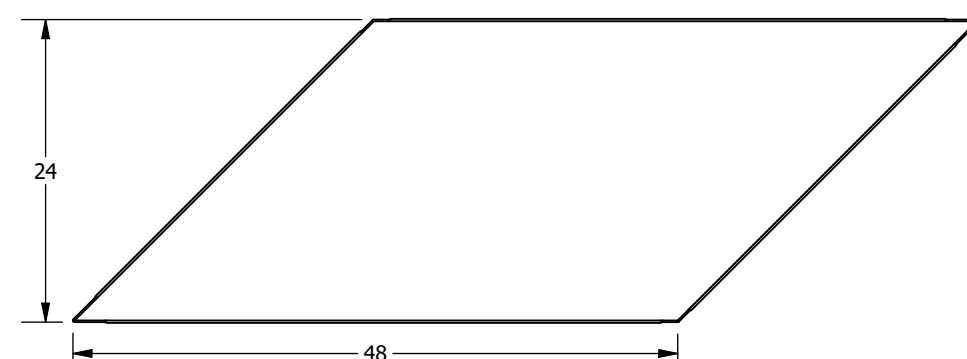

WoodWorks Tegular - 45 Deg. 48 in. Base Right Parallelogram
8274-W1

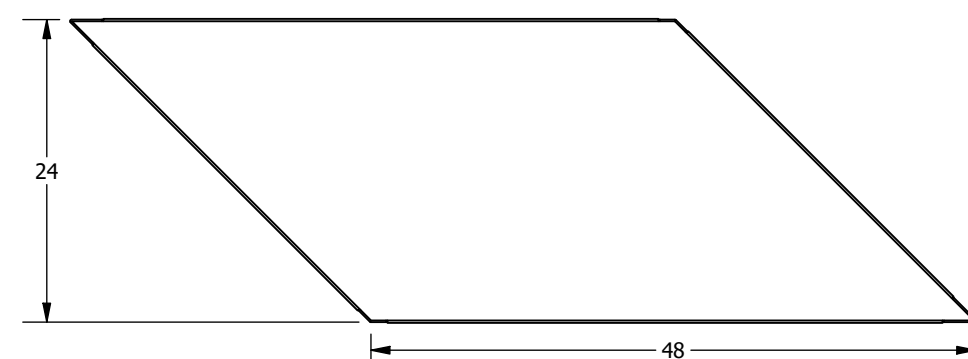

WoodWorks Tegular - 45 Deg. 48 in. Base Left Parallelogram
8275-W1

NOTES:
1. Views are from the face of the panel, and descriptions are based on these views
2. Dimensions are nominal and reflect grid spacings
3. Scale 1:15