

NOTES:
 THE EXAMPLE LAYOUT AND CORRESPONDING BOM SHOWN ARE MEANT TO BE USED AS REFERENCE POINTS WHEN SPECIFYING A DESIGNFLEX SYSTEM.
 IF YOU PLAN TO USE THE EXACT LAYOUT SHOWN, OR ANY VARIATION THEREOF, CONSIDER THE FOLLOWING NOTES:

- 1) DRAWING DETAILS SHOW A CEILING PLAN VIEW WHICH IS FROM A PLENUM POSITION LOOKING DOWN ONTO THE BACKSIDE OF THE CEILING SYSTEM. BOM LISTS DESCRIPTIONS THAT COORDINATE WITH THE DATA PAGES, AND THESE ITEM DESCRIPTIONS ARE BASED ON VIEWING THE FACE OF THE PRODUCTS.
- 2) ANGLE BRACKETS AND CORNER BRACKETS ARE INSTALLED AT STANDARD 6" OC ROUTE HOLE INCREMENTS ALONG THE MAIN BEAMS - ALL MAIN BEAMS ARE INSTALLED WITH ALIGNED ROUTE HOLES.
- 3) ANGLE BRACKETS USED WITHIN LAYOUTS HAVE SCREWS, WASHERS, AND NUTS INCLUDED WITH THEM FOR FASTENING TO MAIN BEAMS. IF CORNER BRACKETS ARE USED IN THE SYSTEM THEY WILL REQUIRE SCREWS THAT ARE NOT INCLUDED AND NEED TO BE SUPPLIED BY OTHERS.
- 4) SCREWS, RIVETS, AND OTHER GENERAL FASTENERS THAT ARE NOT INCLUDED IN BOM OR IN DETAILS BELOW, NEED TO BE SUPPLIED BY OTHERS. REFER TO INSTALLATION INSTRUCTIONS FOR DETAILS ON REQUIRED FASTENERS.
- 5) HANGER WIRE LOCATIONS SHOWN BELOW ARE ONLY SUGGESTIONS BASED ON EXAMPLE LAYOUT AND CAN BE MOVED IN ACCORDANCE WITH FOLLOWING REQUIREMENT - HANGER WIRES ARE REQUIRED ALONG MAINS WITHIN 24" OF THE WALL AND NO MORE THAN 48" O.C THEREAFTER.
- 6) CONDITIONS SHOWN ARE FOR NON-SEISMIC INSTALLATIONS (SEISMIC DESIGN CATEGORY A,B) - REFERENCE INSTALLATION INSTRUCTIONS FOR CONSIDERATIONS AND REQUIREMENTS FOR SEISMIC INSTALLATIONS.
- 7) DETAILS BELOW AND BOM ARE SUBJECT TO CHANGES AT THE PERIMETER BASED ON THE LAYOUT (LINEAR FEET OF PERIMETER, FULL SIZE VS. CUT PANELS, BORDER PANEL INSTALLATION METHOD).
- 8) 7800 WALL ANGLE PERIMETER SHOWN BELOW. REFERENCE INSTALLATION INSTRUCTIONS FOR DETAILS ON ALTERNATIVE PERIMETER SOLUTIONS.
- 9) BOM DOES NOT ACCOUNT FOR THE USE OF SCRAP OR EXCESS MATERIAL CUT FROM OTHER ITEMS.
- 10) REFER TO MASTER PARTS SHEET, PANEL SHEET, AND INSTALLATION INSTRUCTIONS ILLUSTRATIONS SHEET FOR SPECIFIC DETAIL VIEWS AND DIAGRAMS OF ALL PARTS AND PIECES LISTED IN BOM.

SH-0011-2 BILL OF MATERIALS				
ITEM	QTY	STOCK NUMBER	DESCRIPTION	
1	16	7800	Angle Molding	
2	76	7500/7501	12" ID/HD Suprafine Main Beam	
3	190	XL7520	2" Suprafine Cross Tee	
4	181	75CB60L	Suprafine 60 Deg. Left Corner Bracket	
5	181	75CB60R	Suprafine 60 Deg. Right Corner Bracket	
6	190	XM756048	Suprafine 60 Deg. Cross Tee - 48in MBS	
7	20	XM7548	Suprafine Perimeter Cross Tee - 48in MBS	
8	82	BERC2	2" Beam End Retaining Clip	
9	14	XTAC	Cross Tee Adapter Clip	
10	32	PAC	Perimeter Angle Clip	
11	210	100006	Lyra 9/16" Square Tegular - 60 Deg. 48 in Base Left Rt. Triangle	
12	210	100007	Lyra 9/16" Square Tegular - 60 Deg. 48 in Base Right Rt. Triangle	
13	190	STAC	Single Tee Adapter Clip	
14	209	7891	12 Gauge Hanger Wire (Qty. = number of min. hanging point locations)	

EXAMPLE LAYOUT AND BOM SHOWN WITH LYRA PANELS AND SUPRAFINE SUSPENSION SYSTEM

PANEL PRODUCT FAMILIES COMPATIBLE WITH THIS LAYOUT:
 LYRA, OPTIMA, CALLA, AND ULTIMA

SUSPENSION SYSTEMS COMPATIBLE WITH THIS LAYOUT:
 SUPRAFINE ID/HD

SIDE A - REPRESENTS A BORDER CONDITION UTILIZING A SINGLE GRID MEMBER CONNECTION TO THE PERIMETER

SIDE B - REPRESENTS A BORDER CONDITION UTILIZING A SINGLE GRID MEMBER CONNECTION OR MULTIPLE GRID MEMBER CONNECTIONS TO THE PERIMETER

REFERENCE INSTALLATION INSTRUCTIONS FOR FURTHER DETAILS ON HOW THESE BORDER CONDITIONS ARE INSTALLED

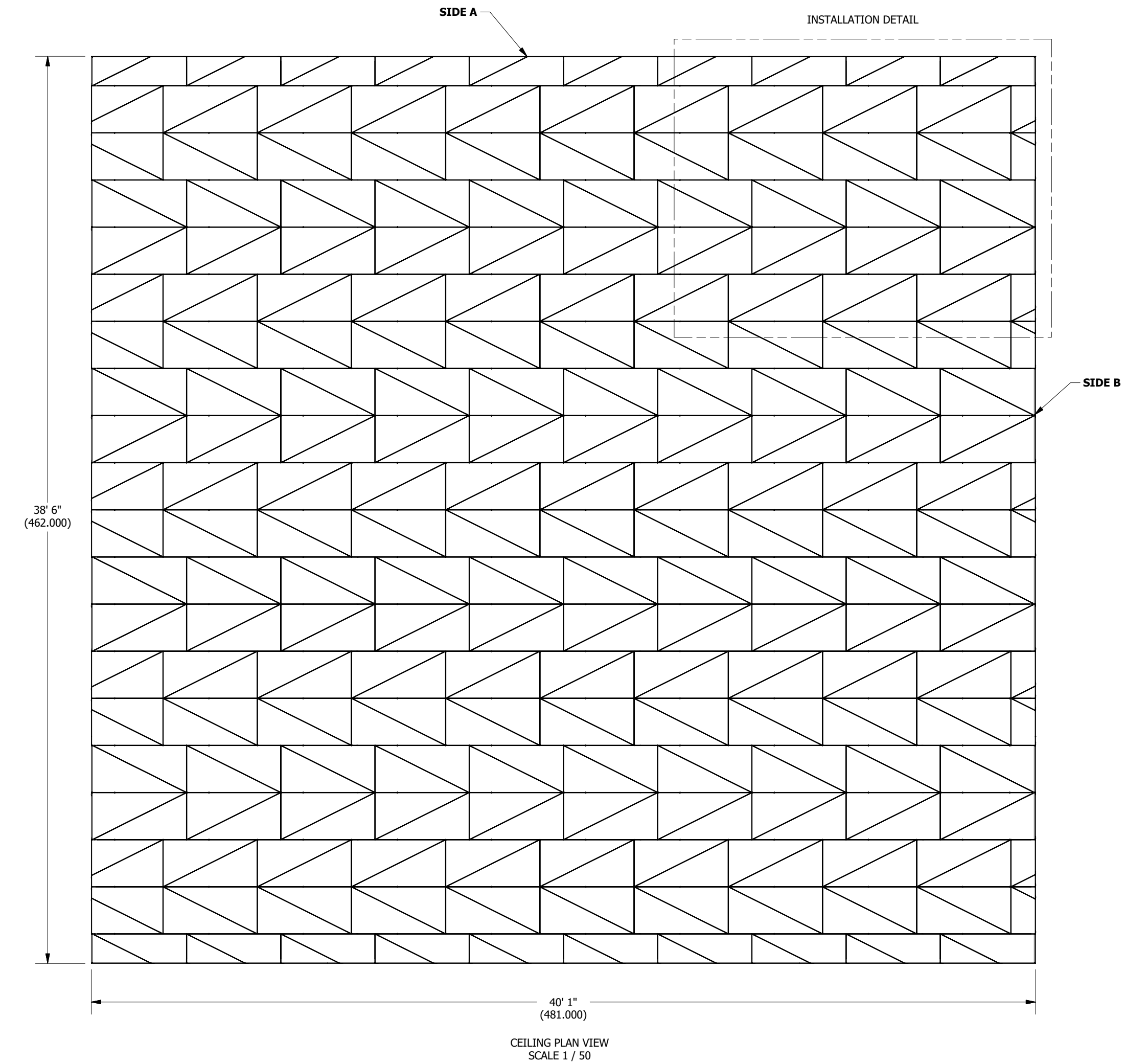
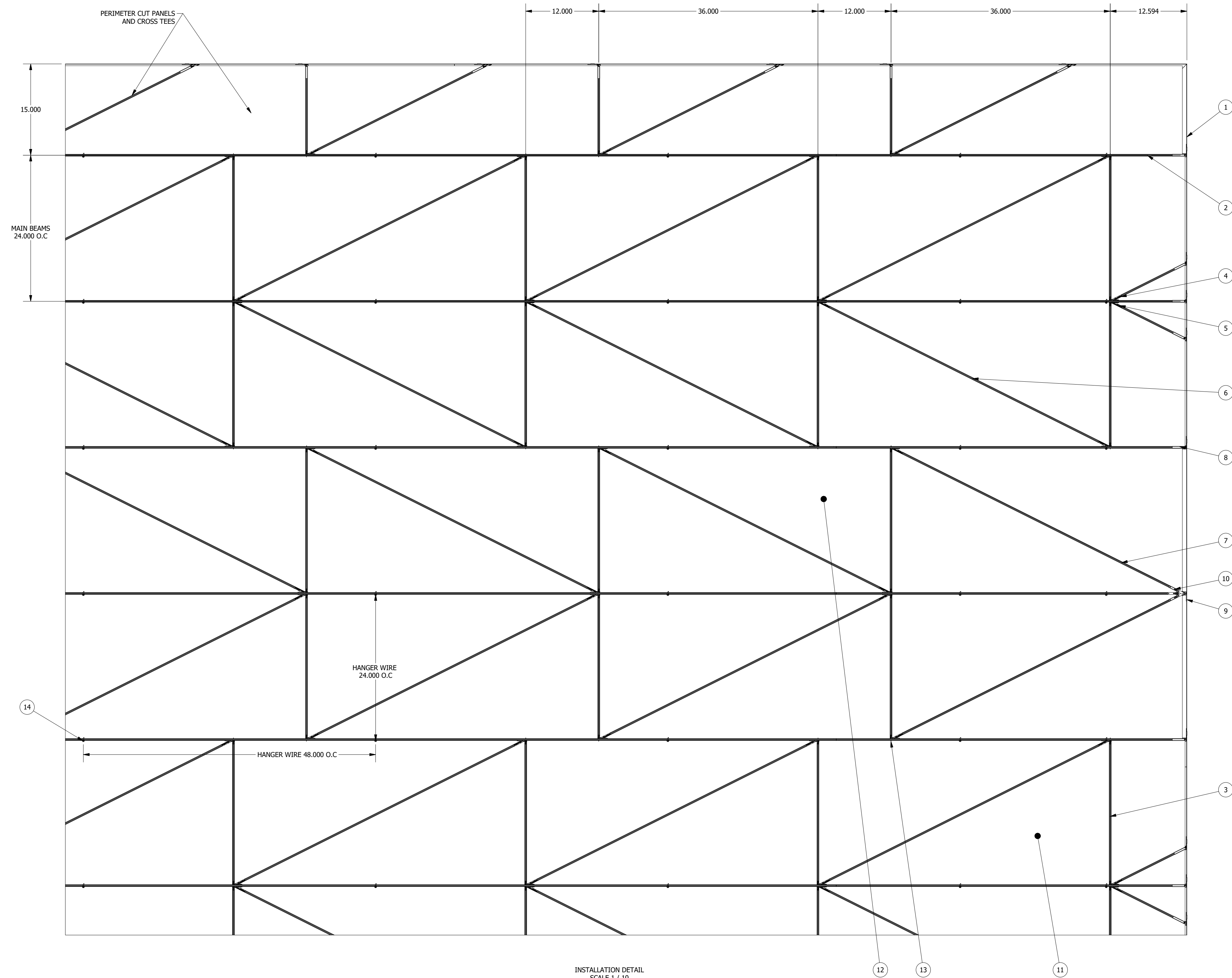

INSTALLATION DETAIL
 SCALE 1 / 10

CEILING PLAN VIEW
 SCALE 1 / 50

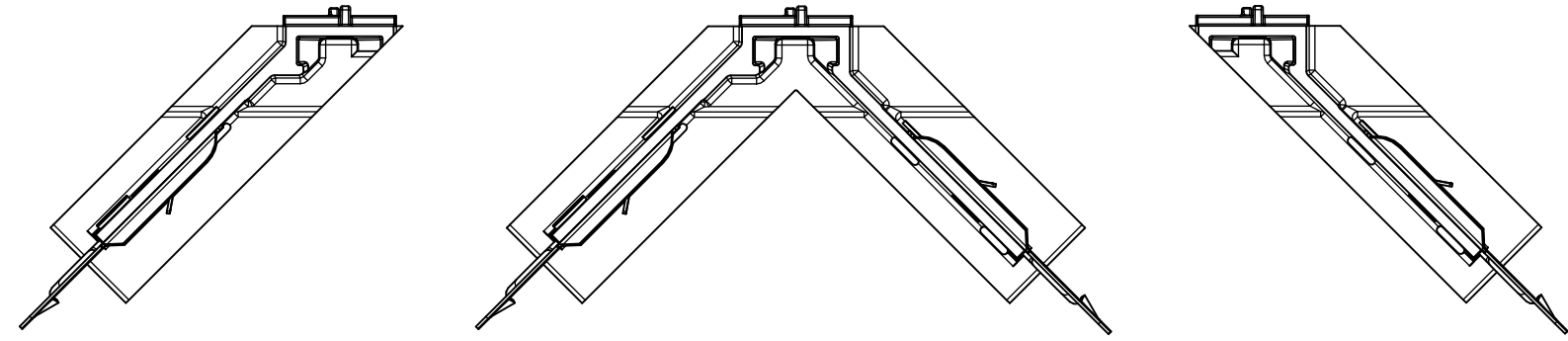

BP75AB45L Suprafine
45° Left Angle Bracket

BP75AB45D Suprafine
45° Double Angle Bracket

BP75AB45R Suprafine
45° Right Angle Bracket

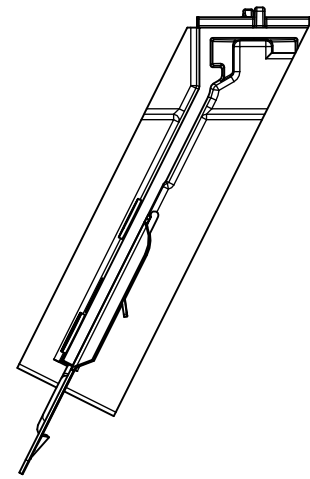

BP75AB60L Suprafine
60° Left Angle Bracket

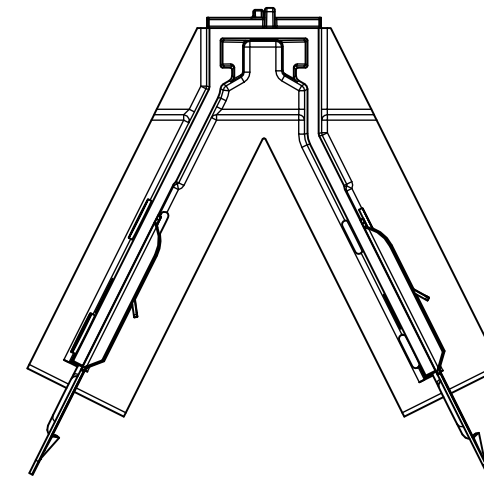

BP75AB60D Suprafine
60° Double Angle Bracket

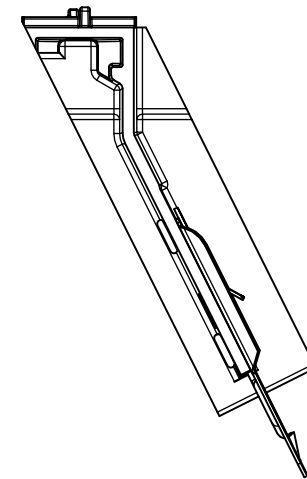

BP75AB60R Suprafine
60° Right Angle Bracket

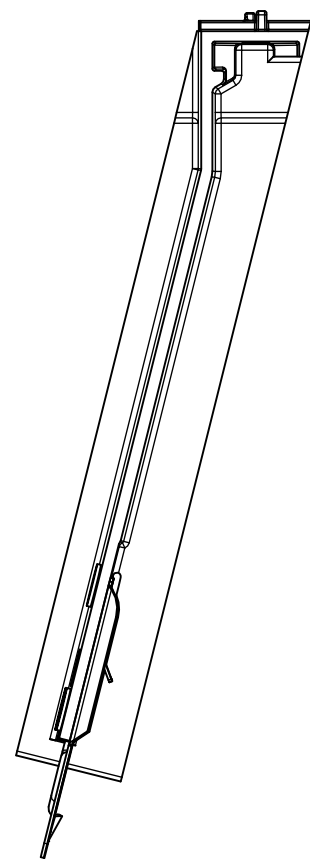

BP75AB75L Suprafine
75° Left Angle Bracket

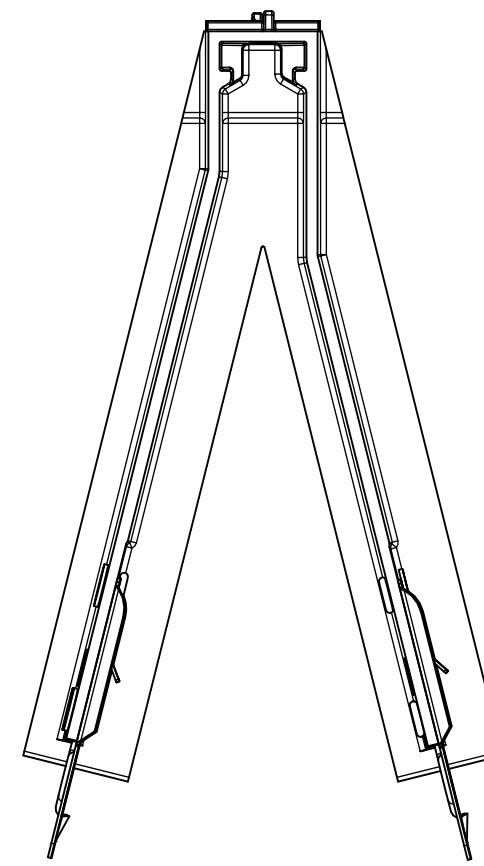

BP75AB75D Suprafine
75° Double Angle Bracket

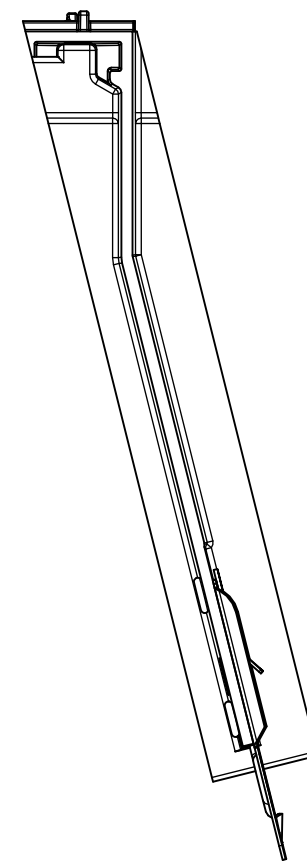

BP75AB75R Suprafine
75° Right Angle Bracket

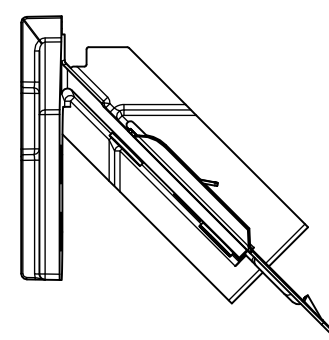

BP75CB45 Suprafine
45° Corner Bracket

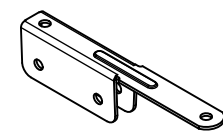

BPPAC
Perimeter Angle Clip
SCALE 1 / 2

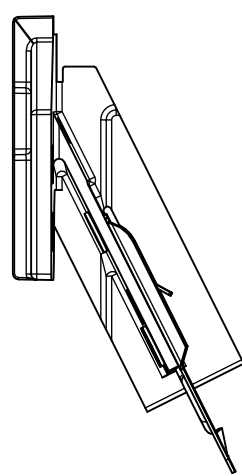

BP75CB60L Suprafine
60° Left Corner Bracket

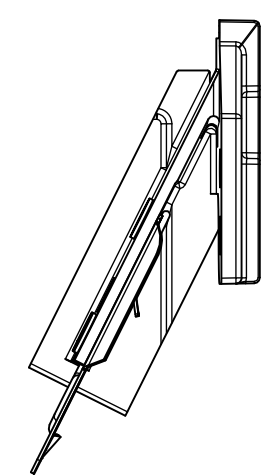

BP75CB60R Suprafine
60° Right Corner Bracket

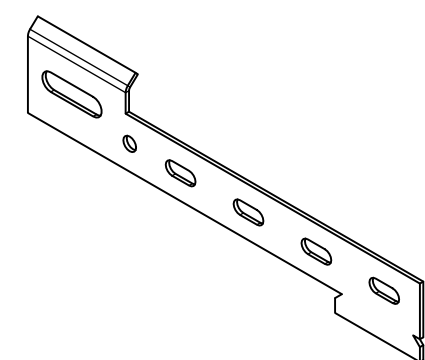

BPPCC
Axiom Perimeter Corner Clip
SCALE 1 / 2

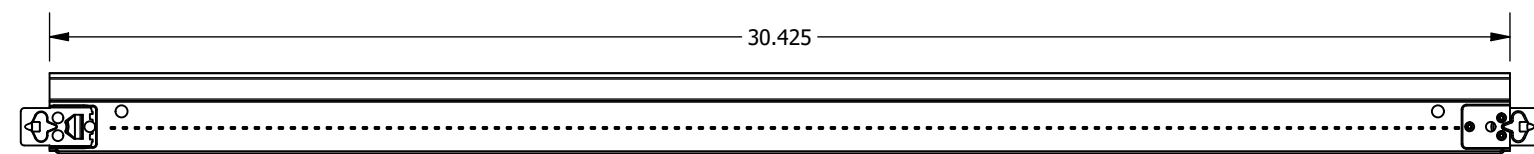

BPM754524 Suprafine
45° Cross Tee - 24" MBS
SCALE 1 / 4

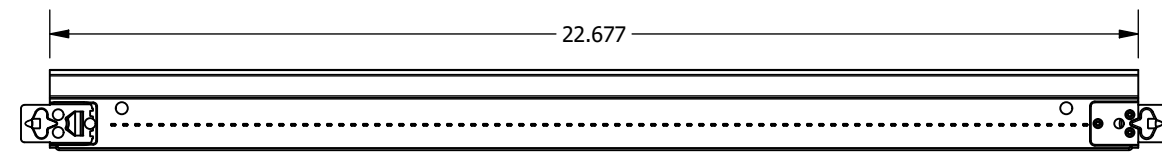

BPM756024 Suprafine
60° Cross Tee - 24" MBS
SCALE 1 / 4

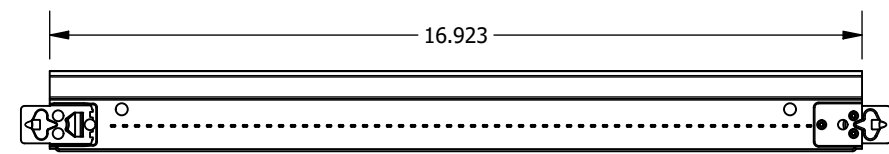

BPM757524 Suprafine
75° Cross Tee - 24" MBS
SCALE 1 / 4

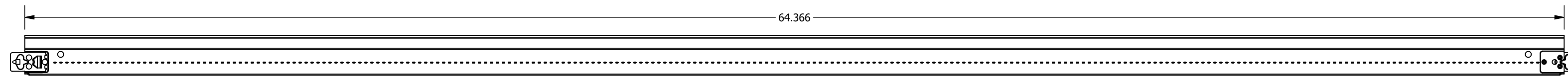

BPM754548 Suprafine
45° Cross Tee - 48" MBS
SCALE 1 / 4

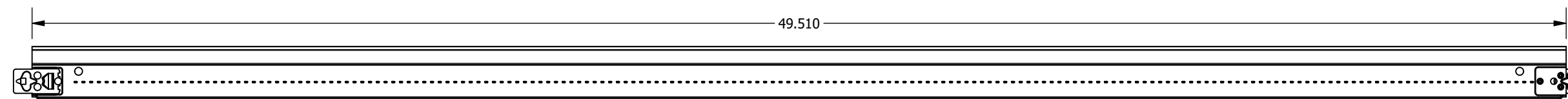

BPM756048 Suprafine
60° Cross Tee - 48" MBS
SCALE 1 / 4

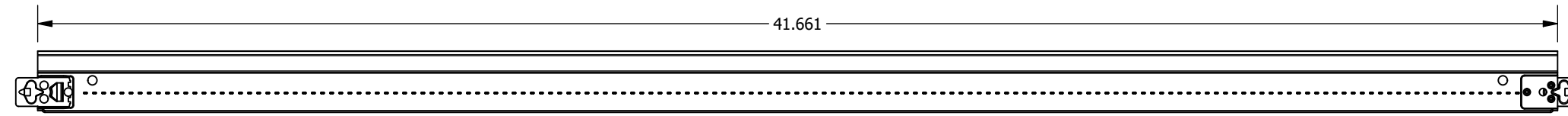

BPM757548 Suprafine
75° Cross Tee - 48" MBS
SCALE 1 / 4

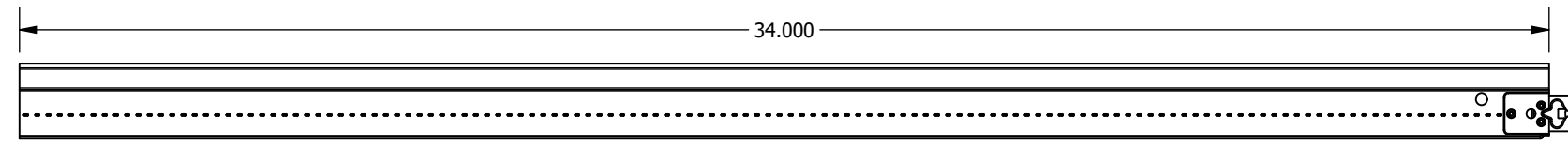

BPM7524 Suprafine
Perimeter Cross Tee - 24" MBS
SCALE 1 / 4

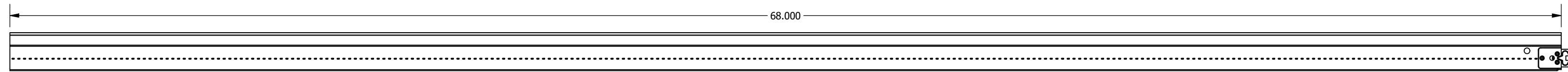

BPM7548 Suprafine
Perimeter Cross Tee - 48" MBS
SCALE 1 / 4

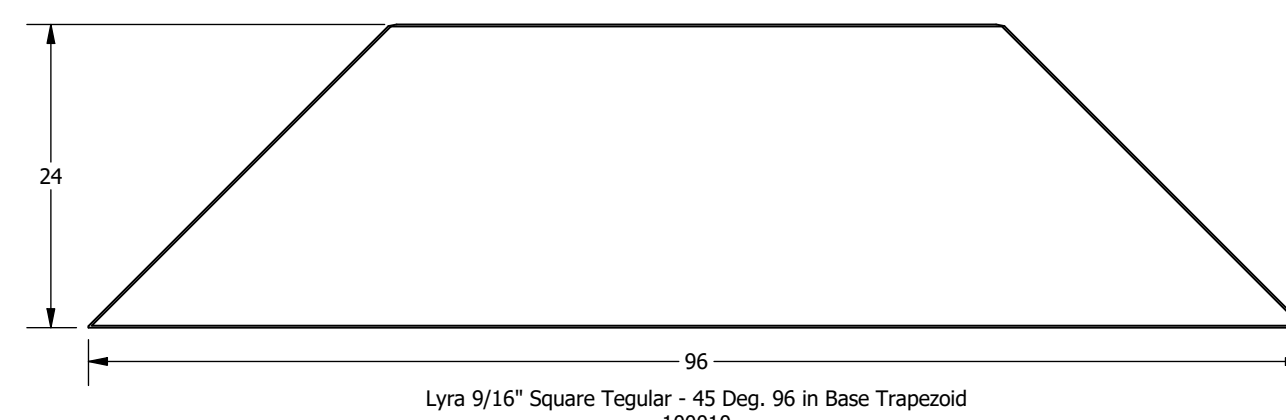
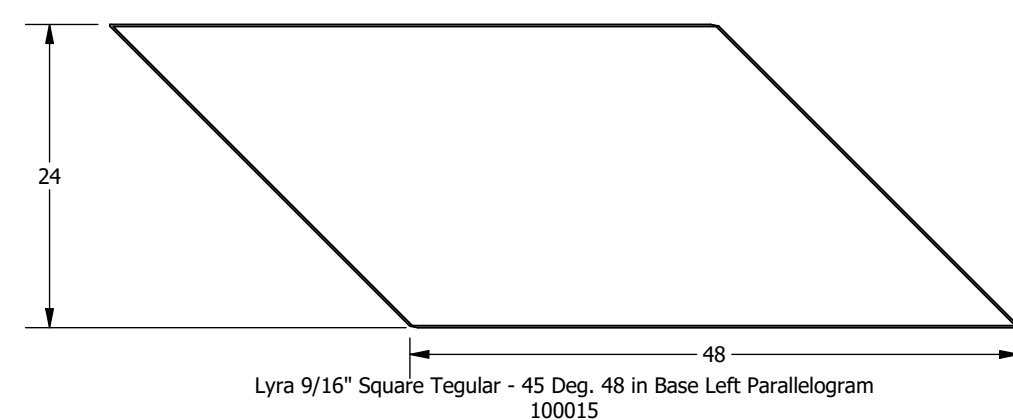
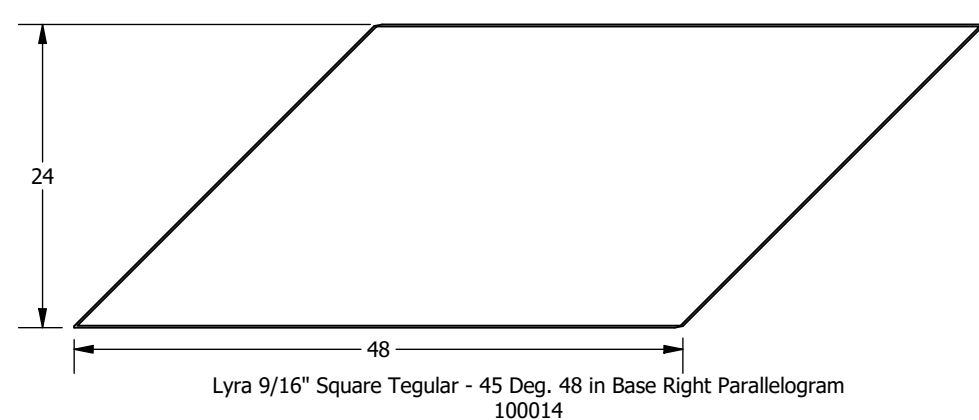
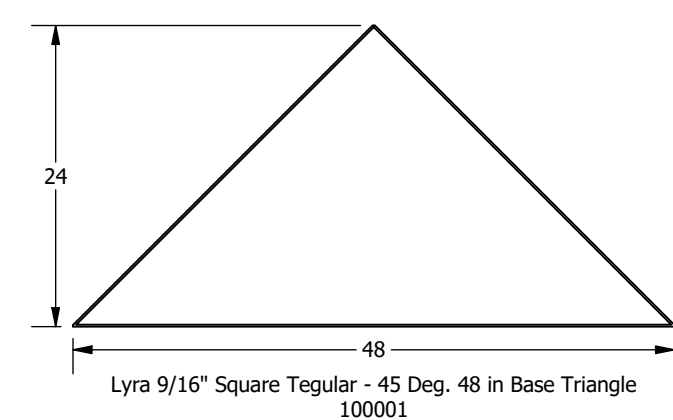
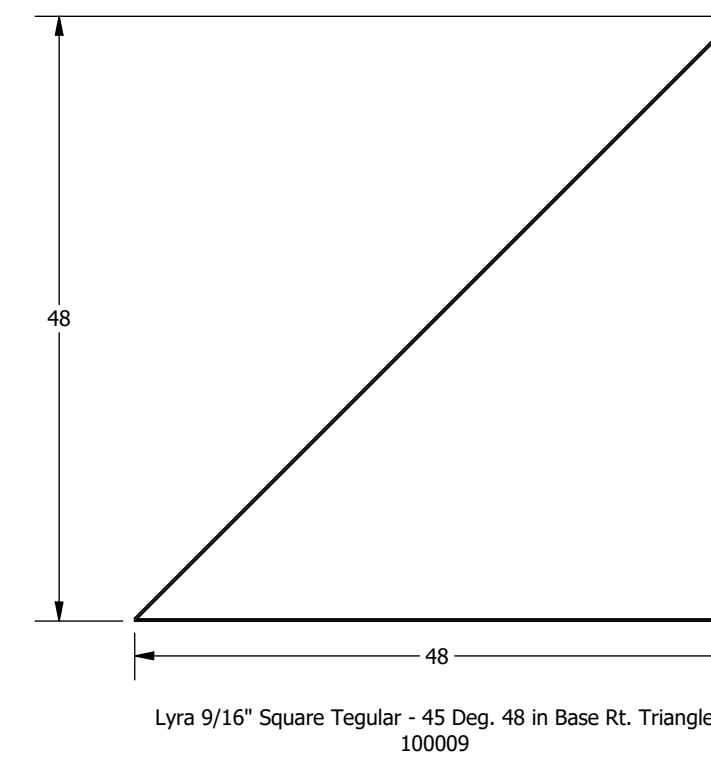
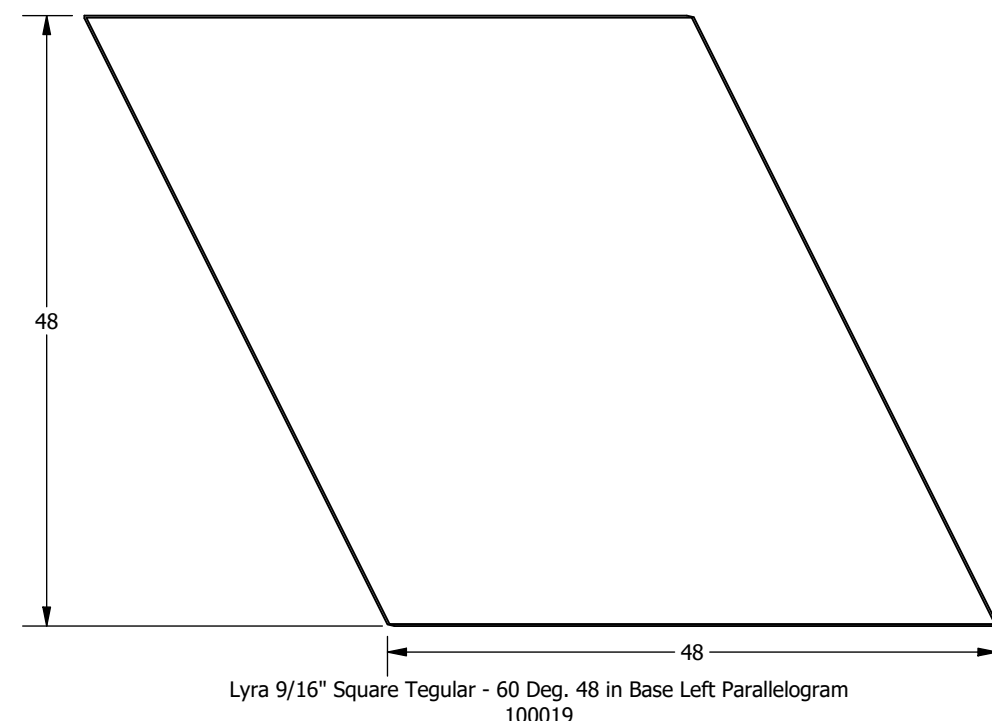
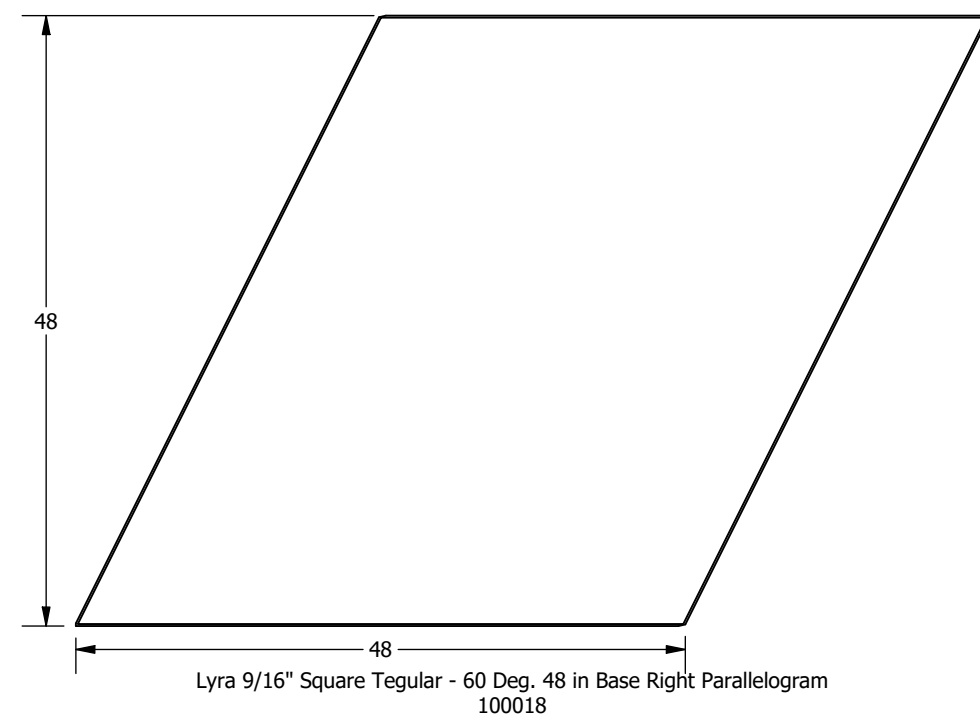
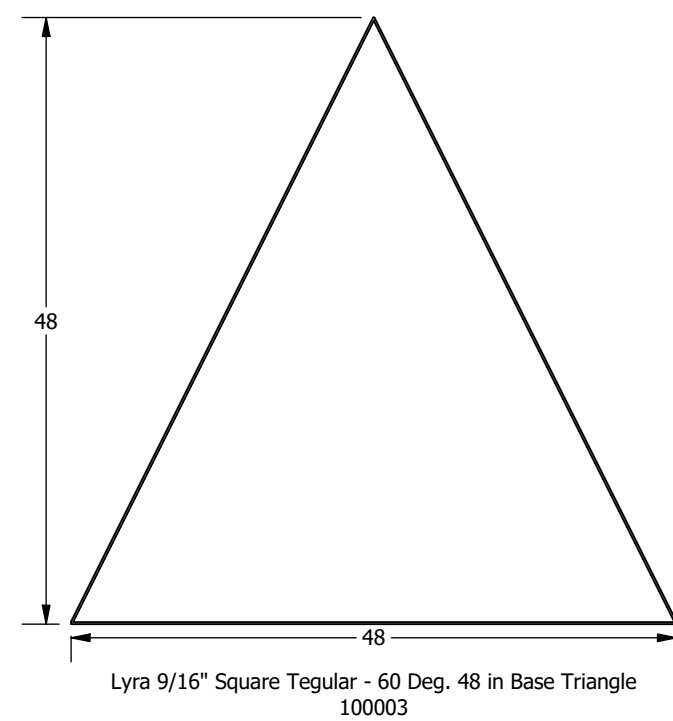
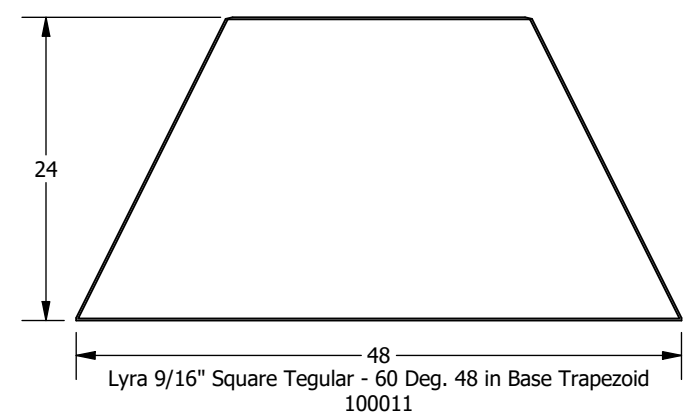
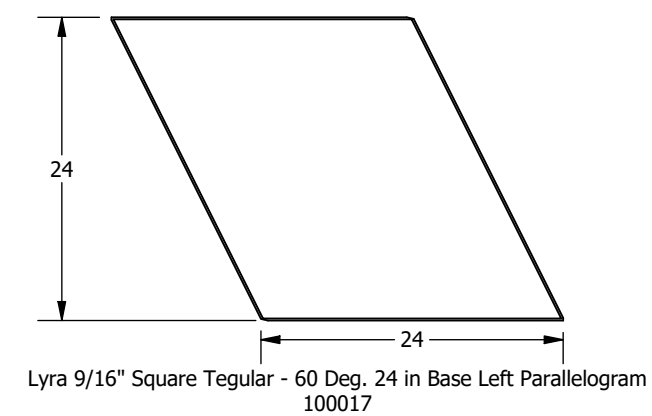
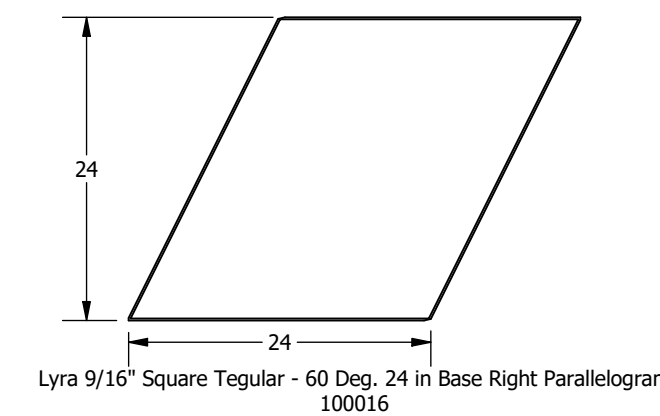
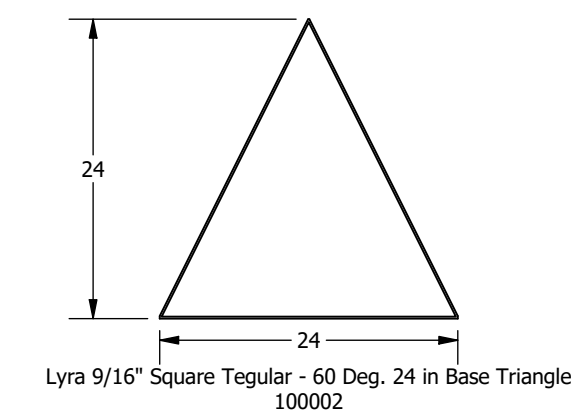
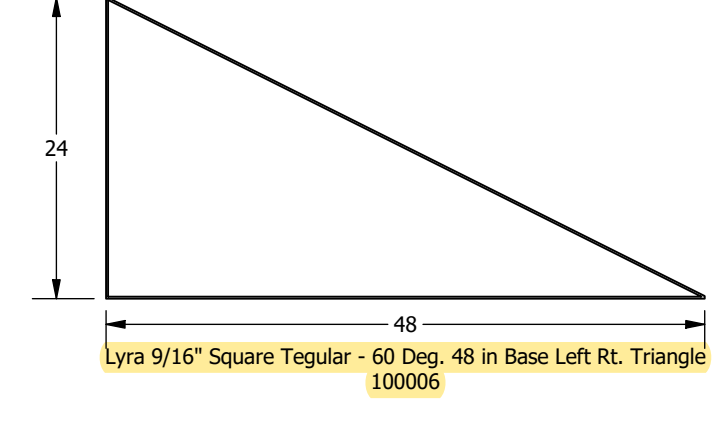
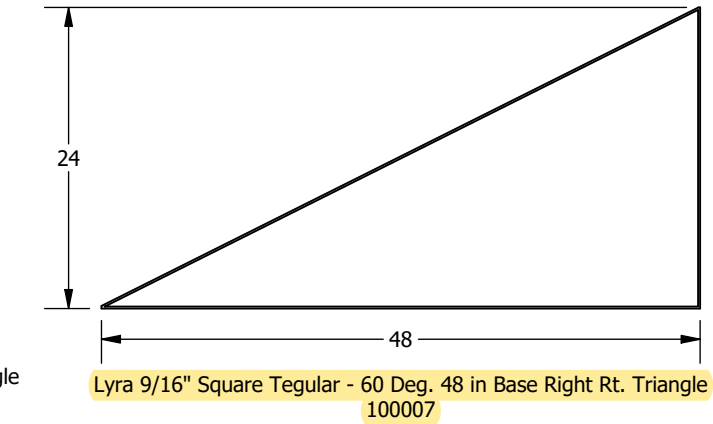
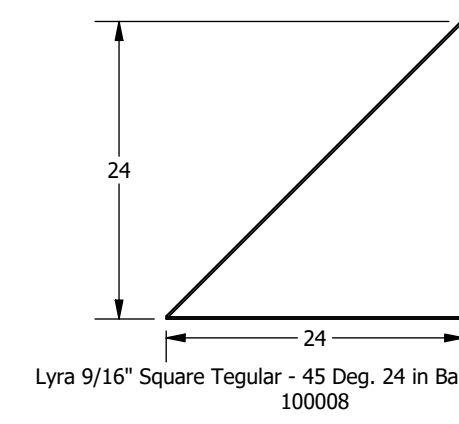
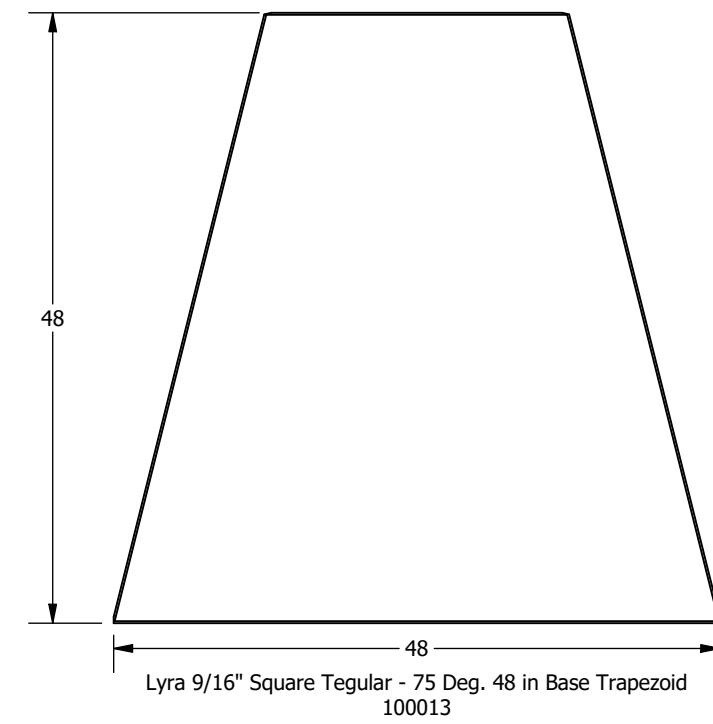
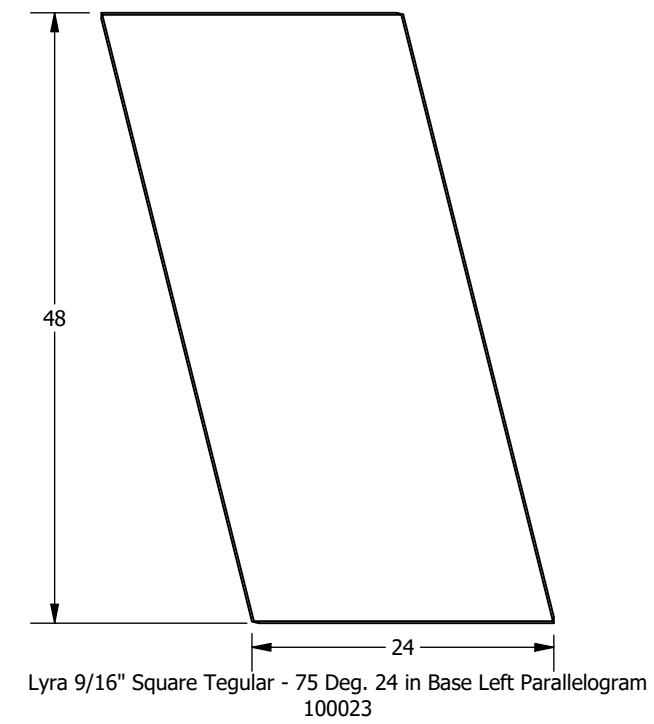
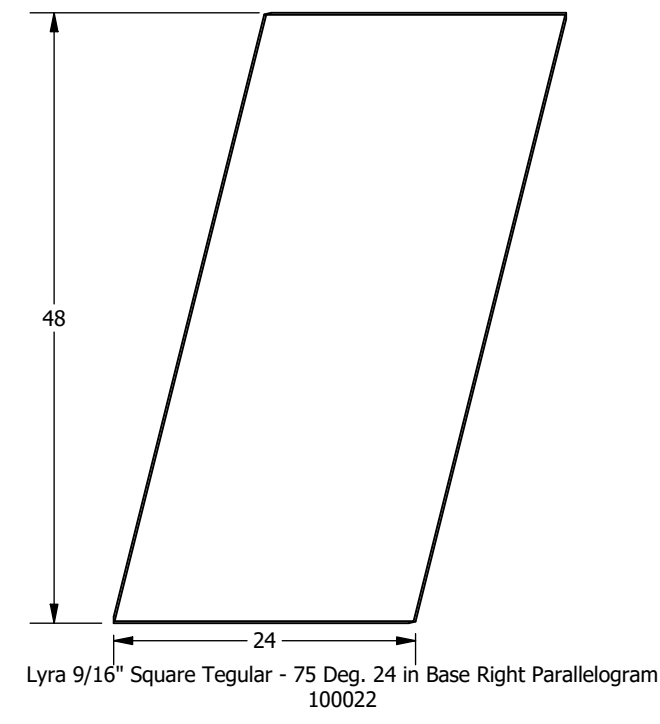
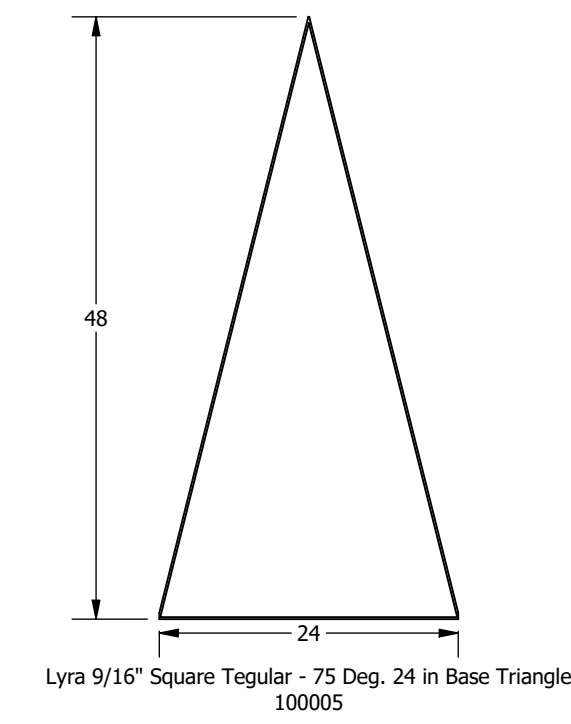
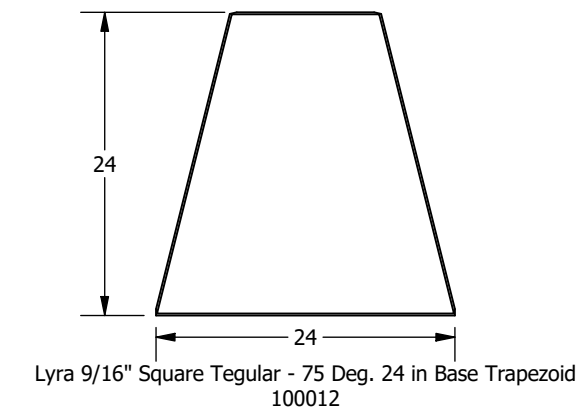
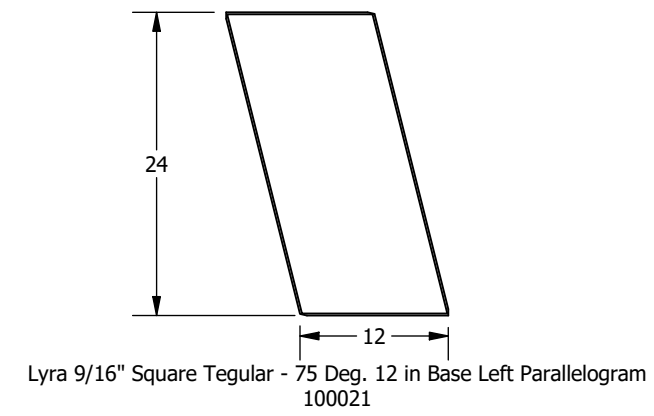
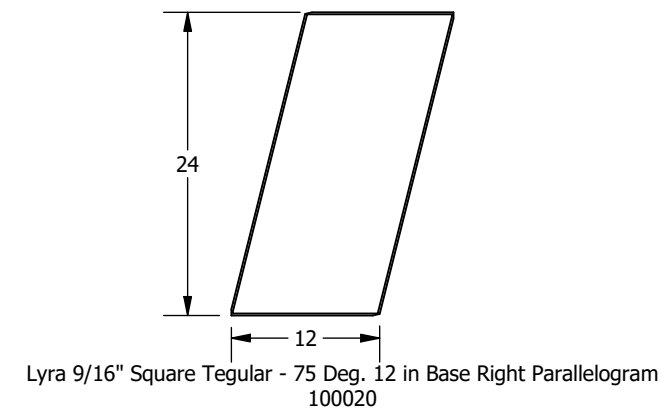
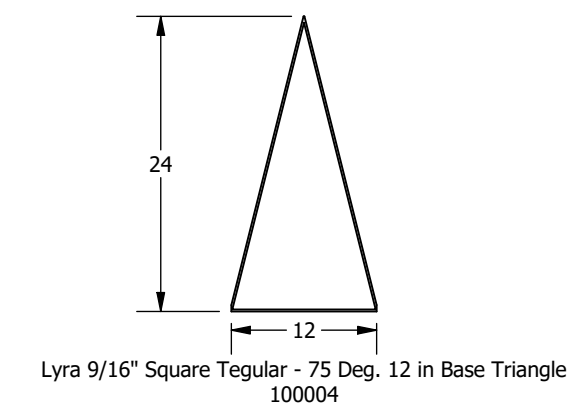

NOTES:
1. Views are from the face of the panel, and descriptions are based on these views
2. Dimensions are nominal and reflect grid spacings
3. Scale 1:15

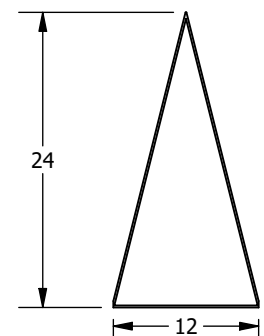

Calla 9/16" Square Tegular - 75 Deg. 12 in Base Triangle
100103

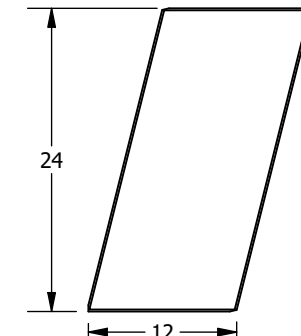

Calla 9/16" Square Tegular - 75 Deg. 12 in Base Right Parallelogram
100116

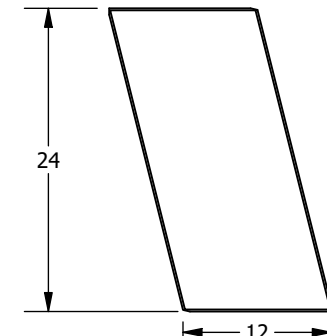

Calla 9/16" Square Tegular - 75 Deg. 12 in Base Left Parallelogram
100117

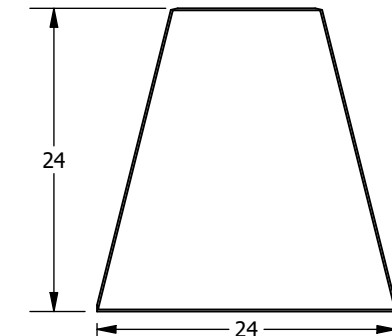

Calla 9/16" Square Tegular - 75 Deg. 24 in Base Trapezoid
100110

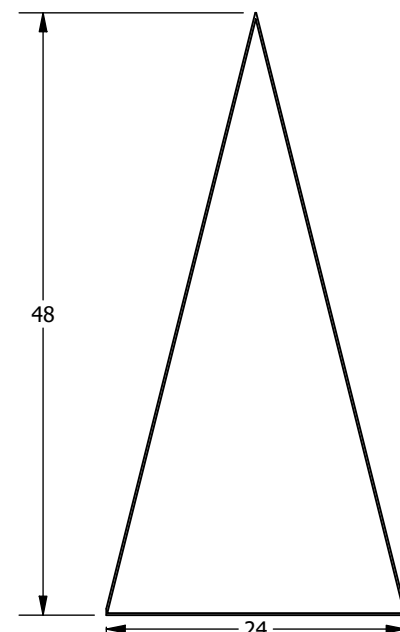

Calla 9/16" Square Tegular - 75 Deg. 24 in Base Triangle
100104

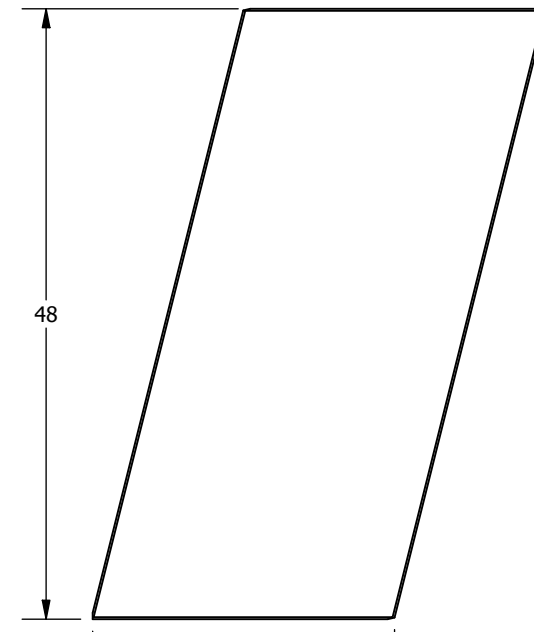

Calla 9/16" Square Tegular - 75 Deg. 24 in Base Right Parallelogram
100118

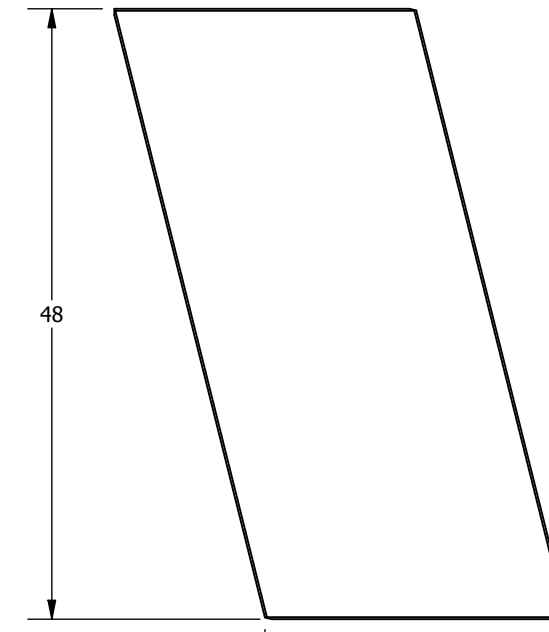

Calla 9/16" Square Tegular - 75 Deg. 24 in Base Left Parallelogram
100119

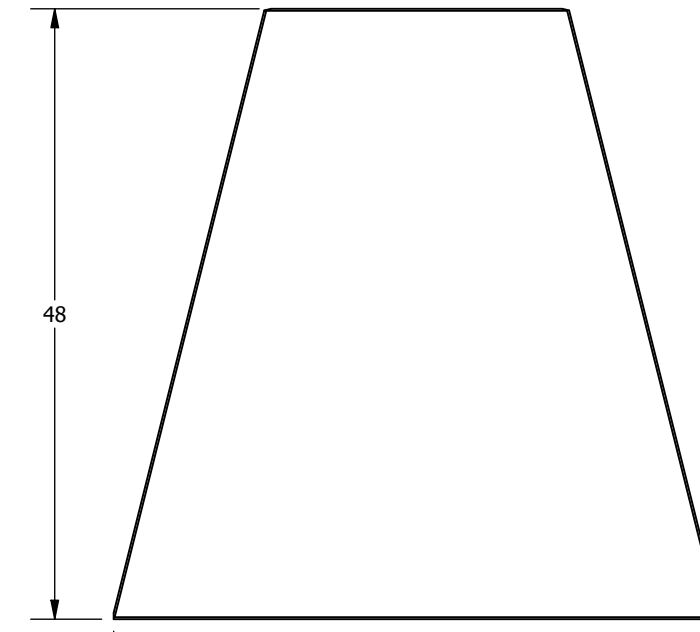

Calla 9/16" Square Tegular - 75 Deg. 48 in Base Trapezoid
100111

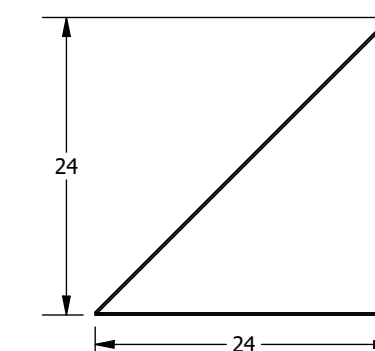

Calla 9/16" Square Tegular - 45 Deg. 24 in Base Rt. Triangle
100107

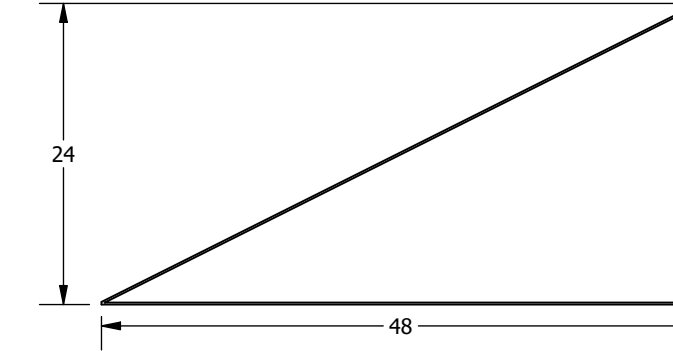

Calla 9/16" Square Tegular - 60 Deg. 48 in Base Right Rt. Triangle
100106

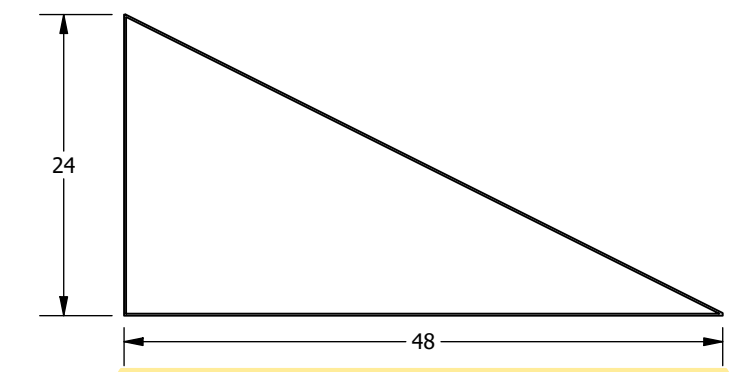

Calla 9/16" Square Tegular - 60 Deg. 48 in Base Left Rt. Triangle
100105

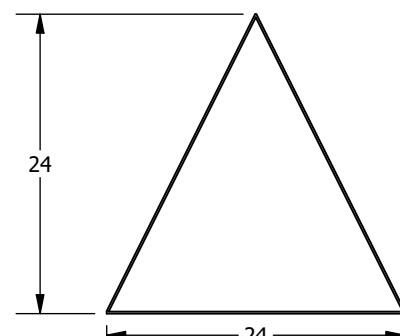

Calla 9/16" Square Tegular - 60 Deg. 24 in Base Triangle
100101

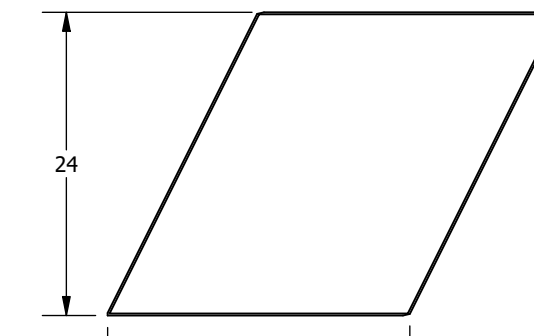

Calla 9/16" Square Tegular - 60 Deg. 24 in Base Right Parallelogram
100114

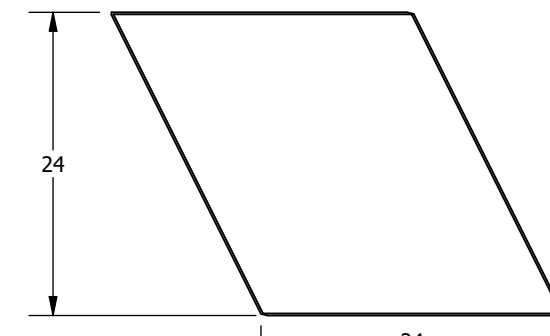

Calla 9/16" Square Tegular - 60 Deg. 24 in Base Left Parallelogram
100115

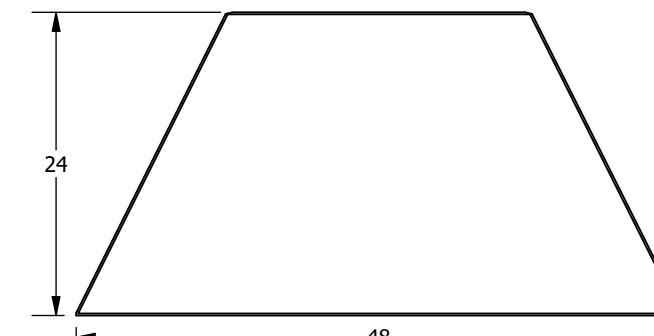

Calla 9/16" Square Tegular - 60 Deg. 48 in Base Trapezoid
100109

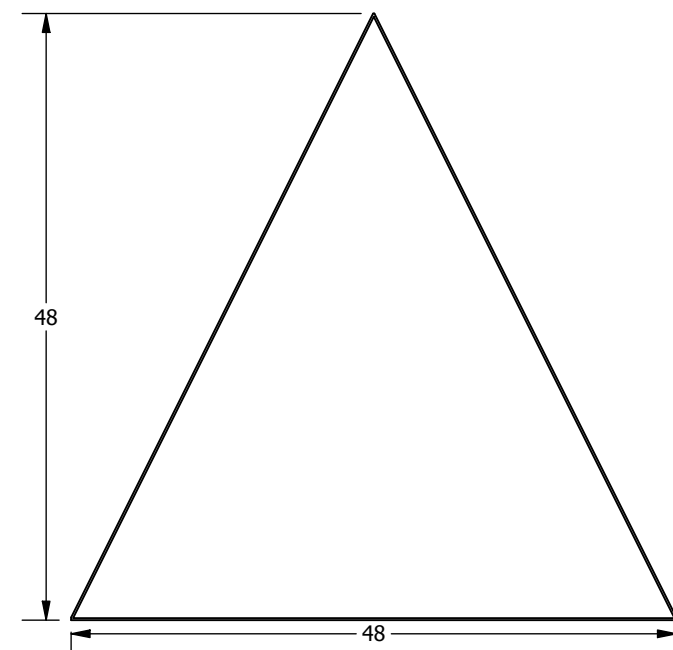

Calla 9/16" Square Tegular - 60 Deg. 48 in Base Triangle
100102

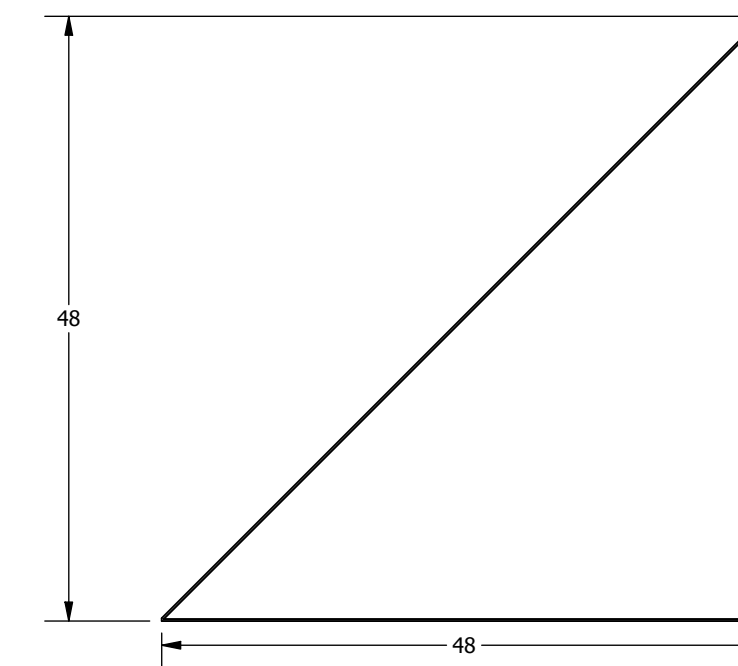

Calla 9/16" Square Tegular - 45 Deg. 48 in Base Rt. Triangle
100108

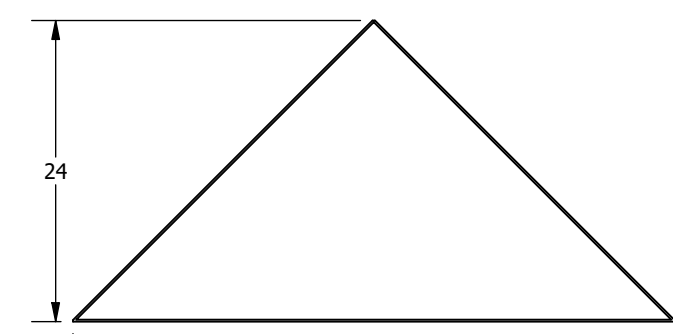

Calla 9/16" Square Tegular - 45 Deg. 48 in Base Triangle
100100

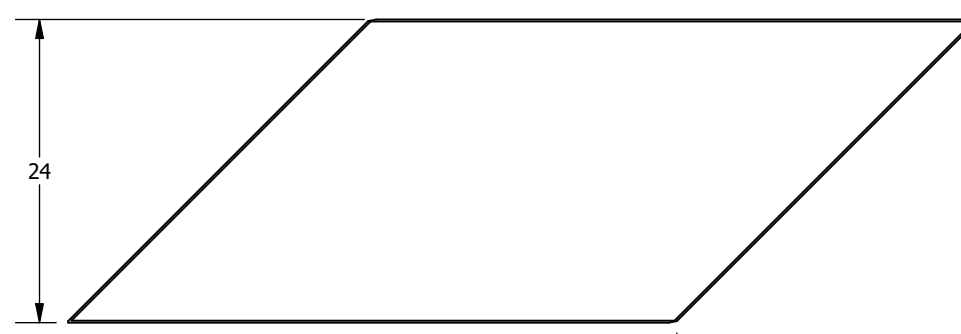

Calla 9/16" Square Tegular - 45 Deg. 48 in Base Right Parallelogram
100112

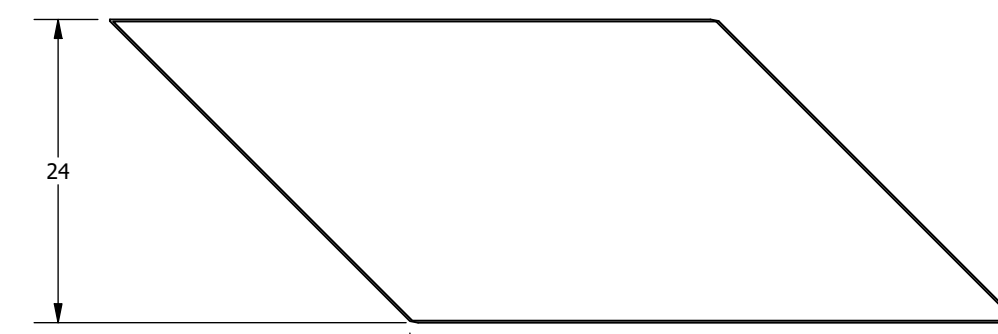

Calla 9/16" Square Tegular - 45 Deg. 48 in Base Left Parallelogram
100113

NOTES:
1. Views are from the face of the panel, and descriptions are based on these views
2. Dimensions are nominal and reflect grid spacings
3. Scale 1:15

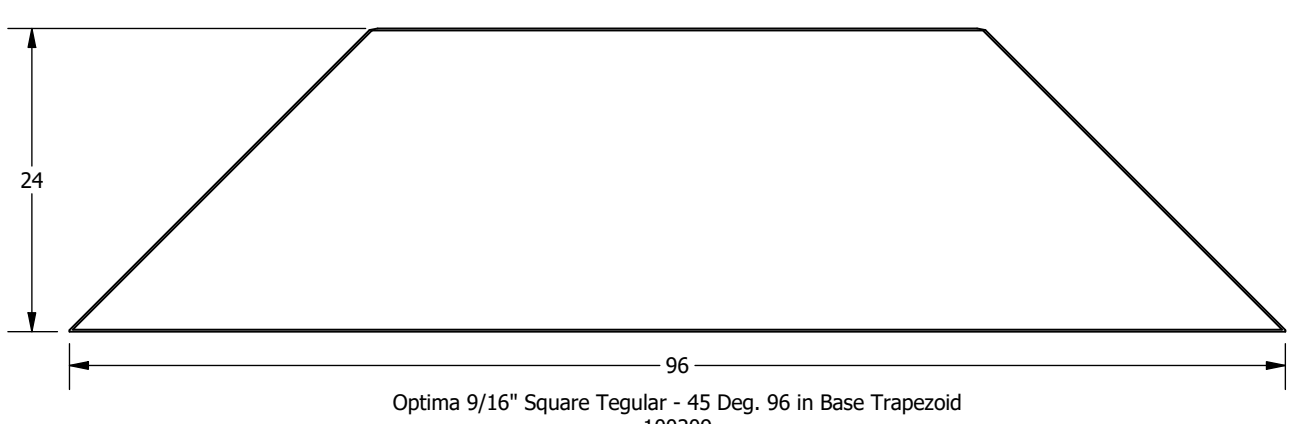
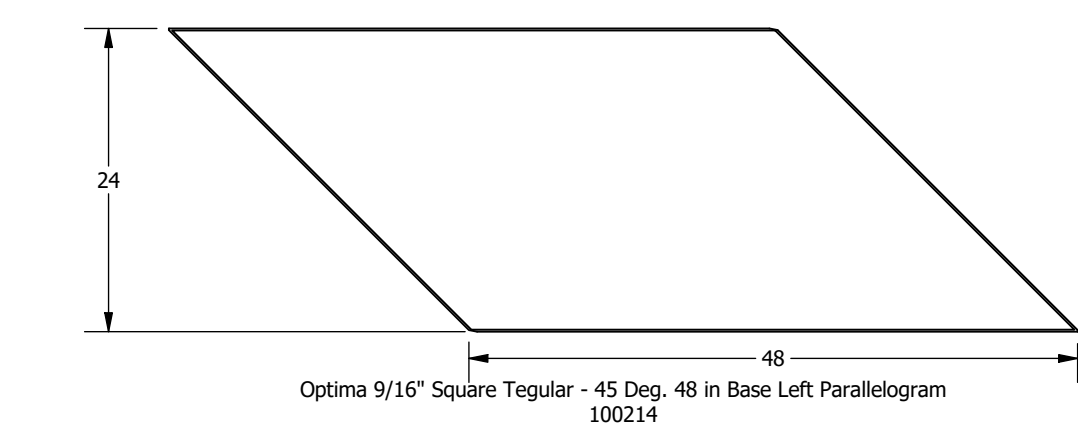
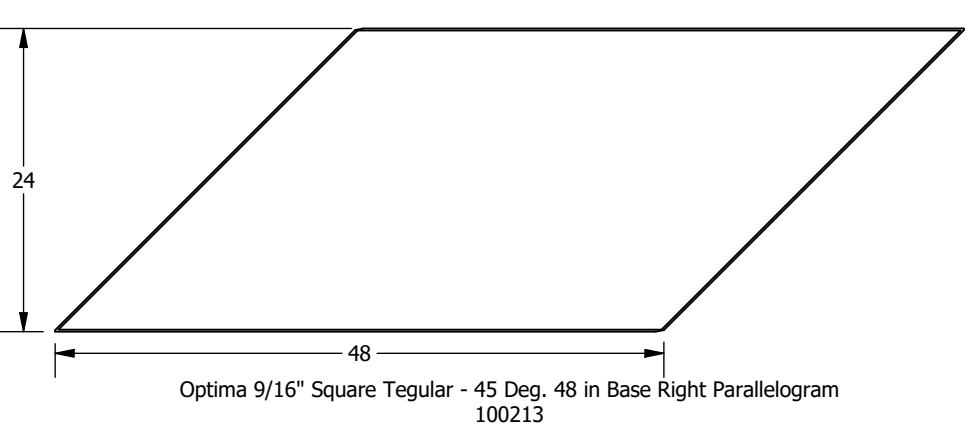
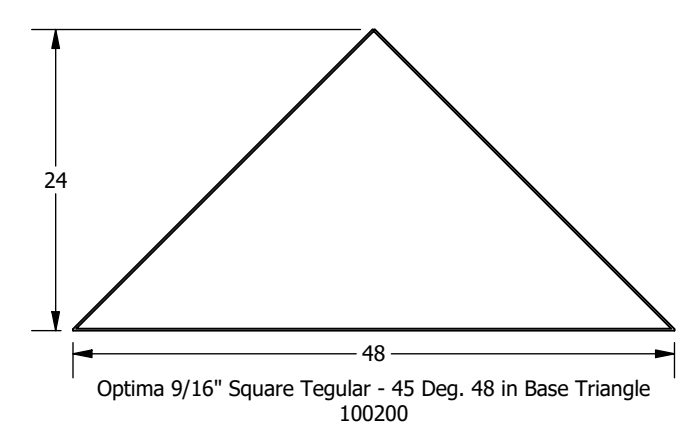
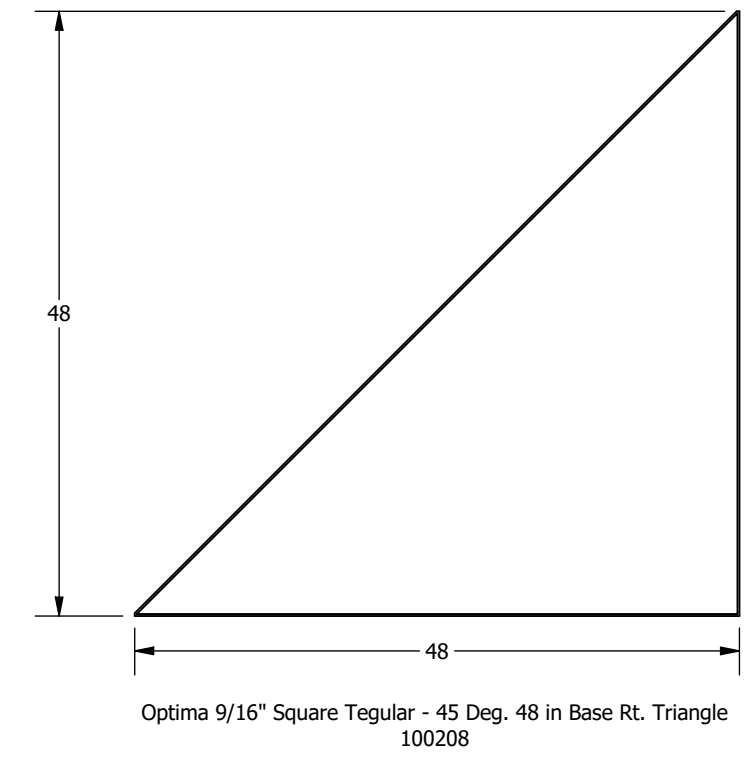
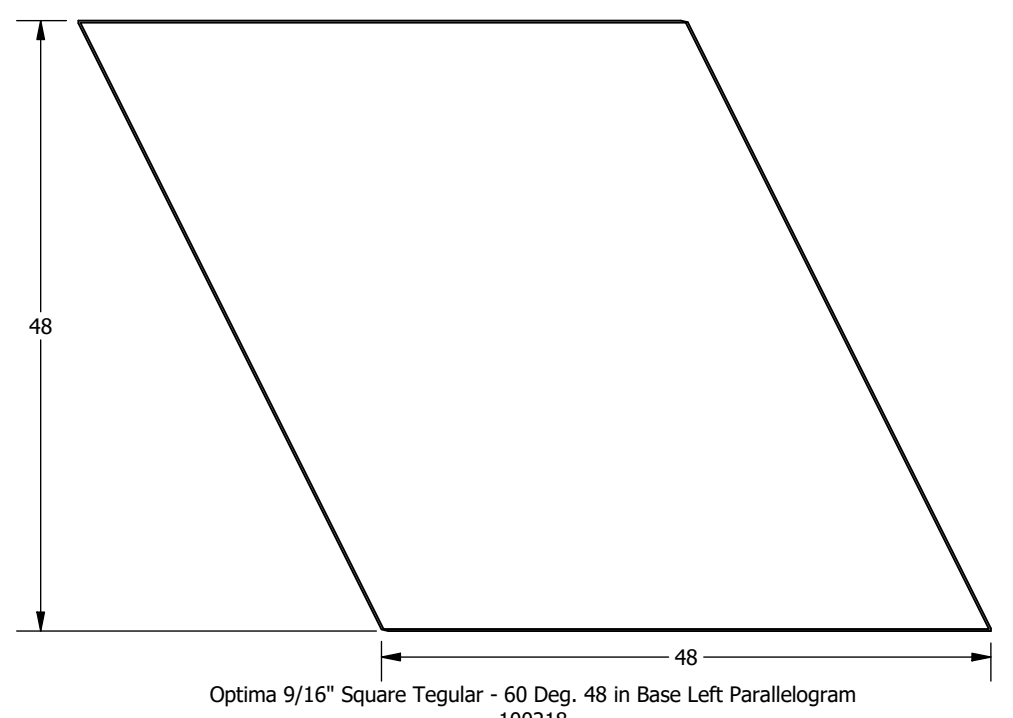
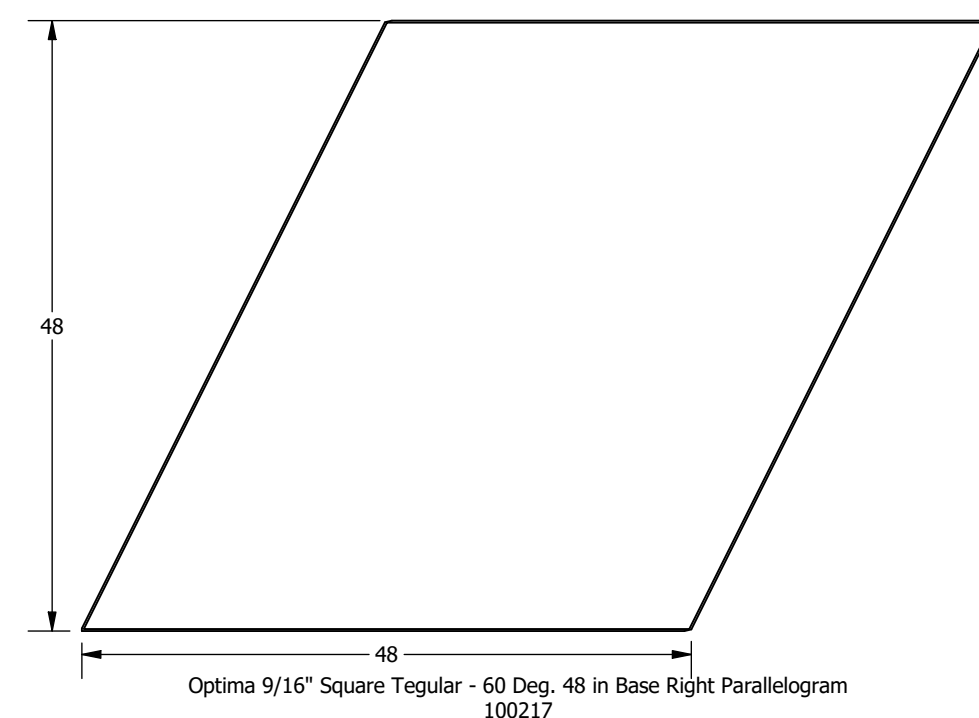
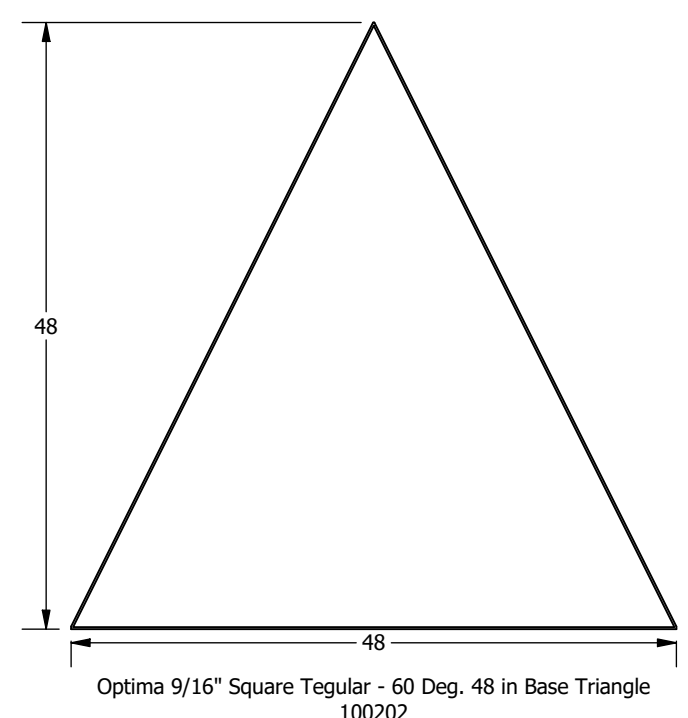
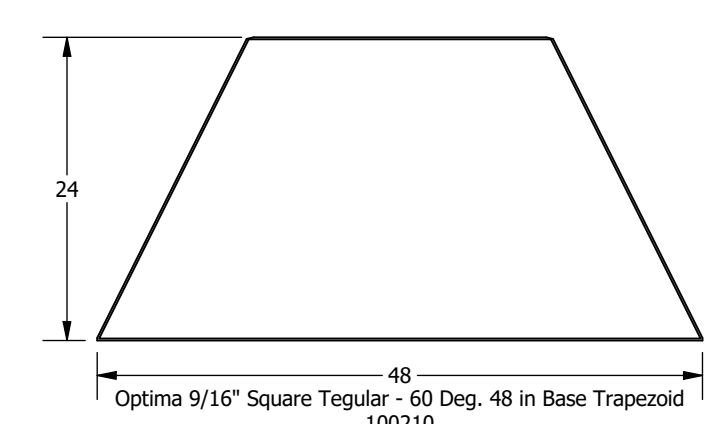
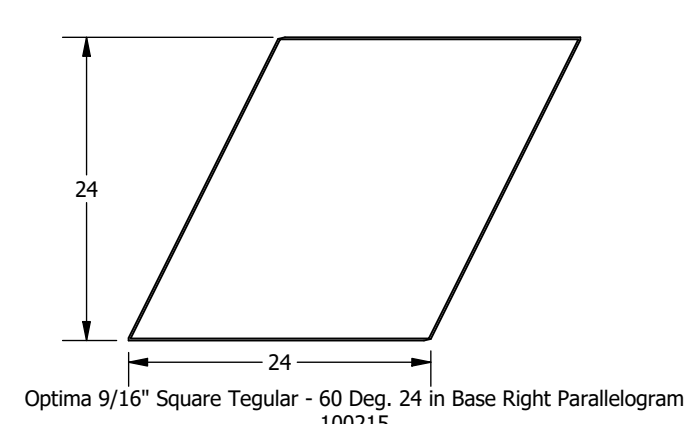
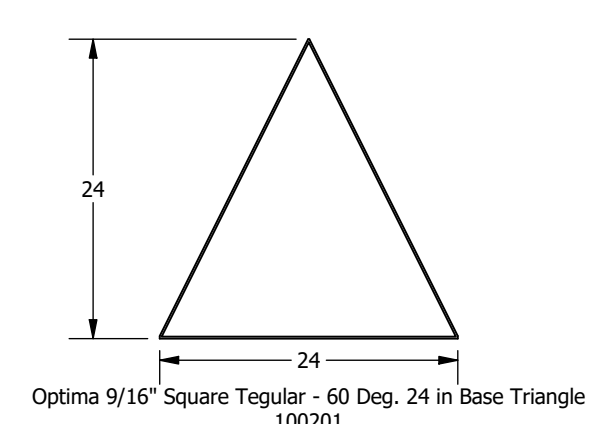
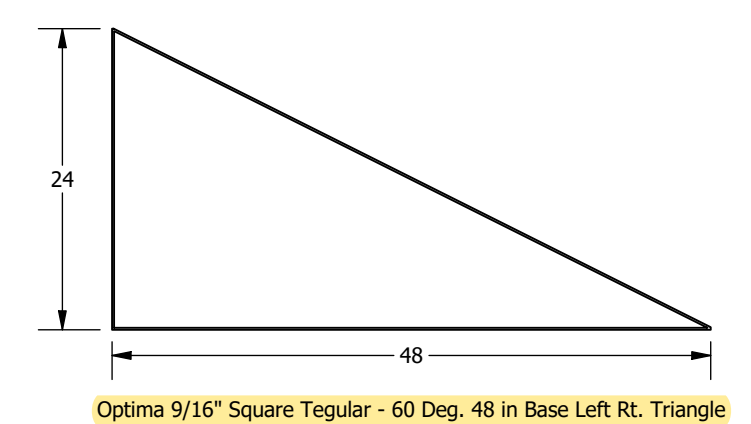
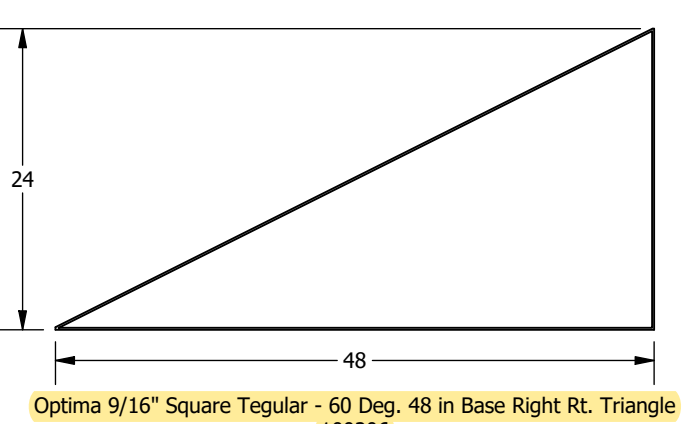
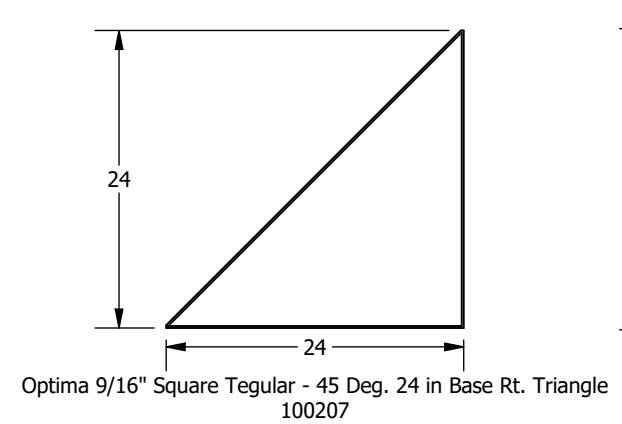
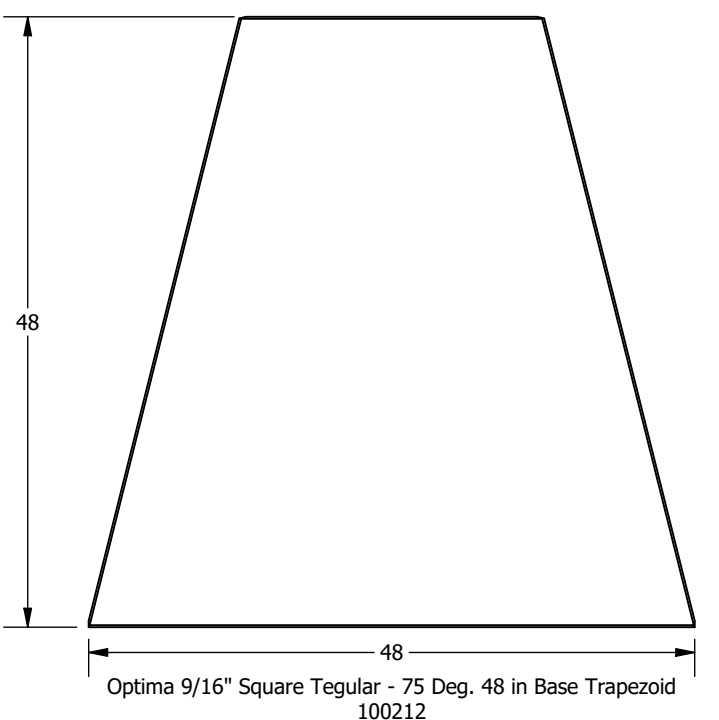
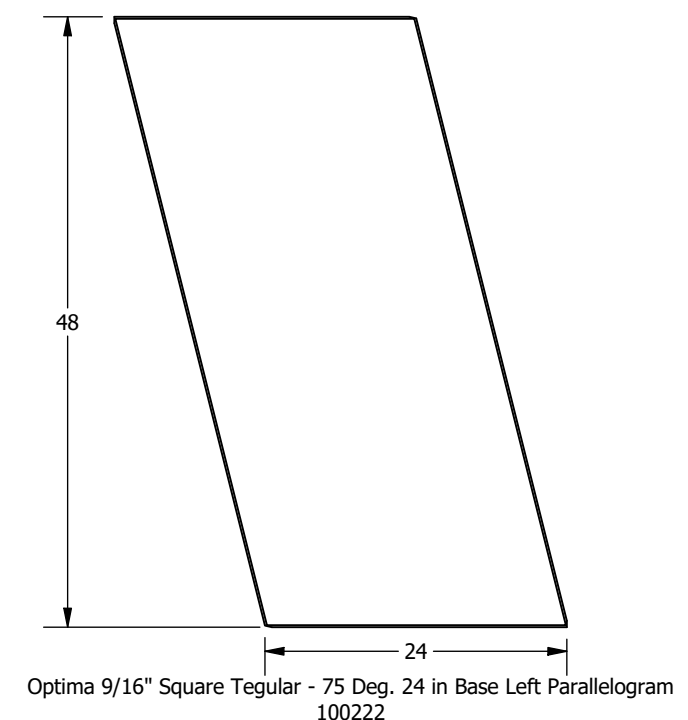
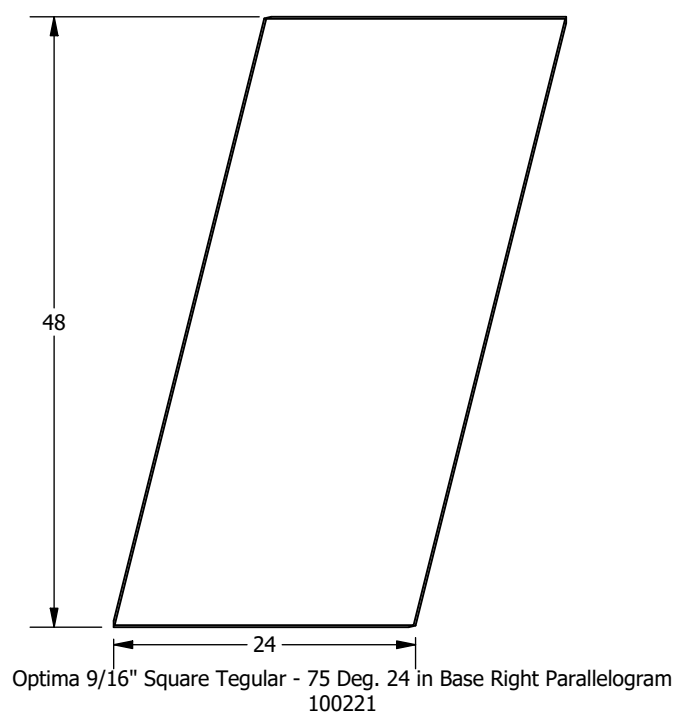
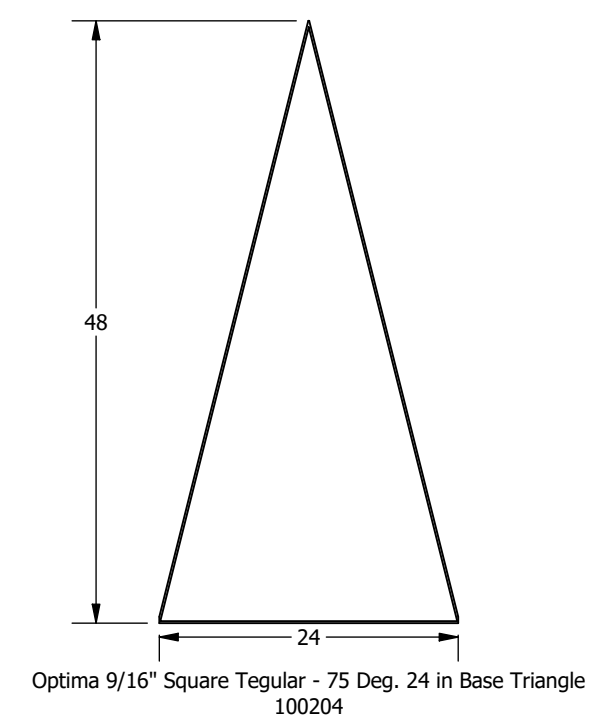
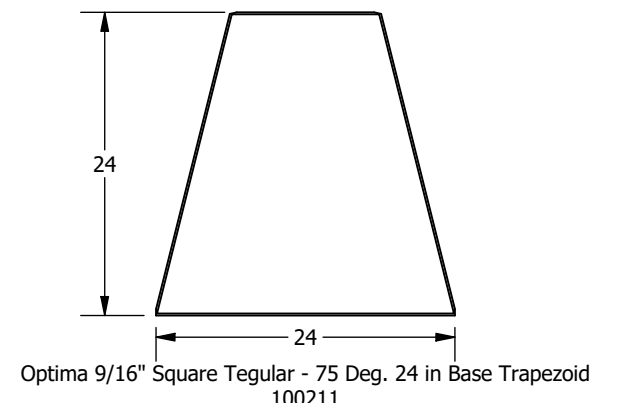
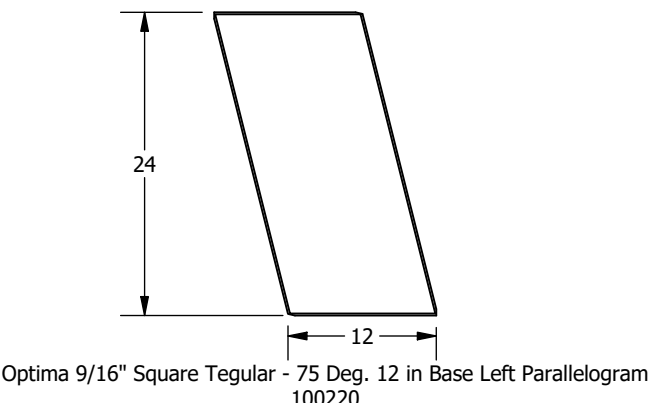
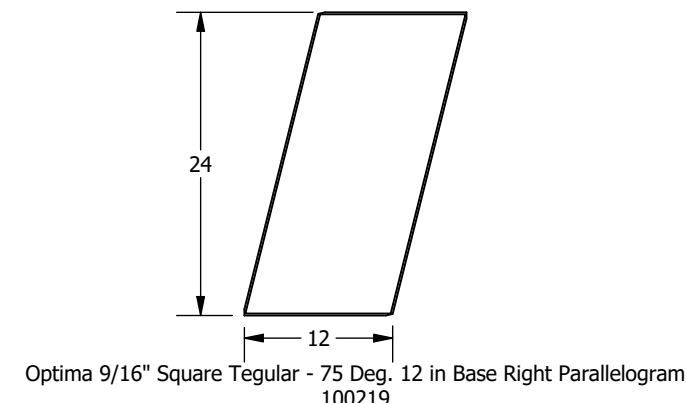
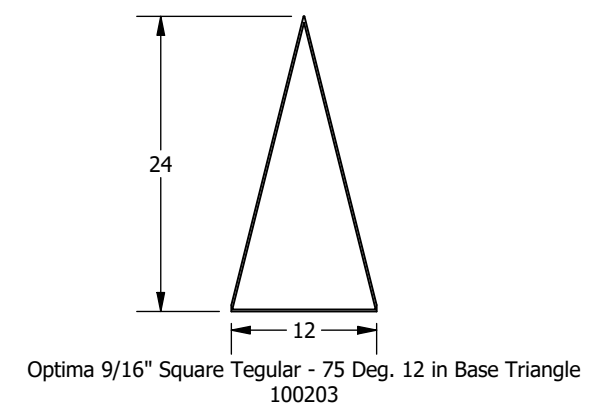

NOTES:
1. Views are from the face of the panel, and descriptions are based on these views
2. Dimensions are nominal and reflect grid spacings
3. Scale 1:15

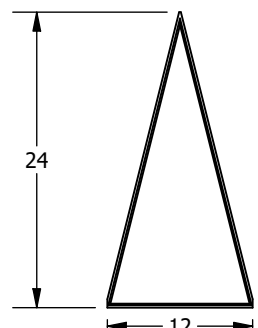

Ultima 9/16 Beveled Tegular - 75 Deg. 12 in Base Triangle
100303

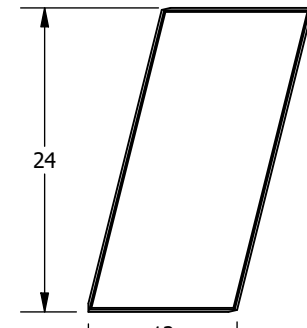

Ultima 9/16 Beveled Tegular - 75 Deg. 12 in Base Right Parallelogram
100315

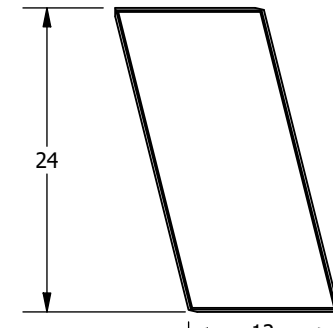

Ultima 9/16 Beveled Tegular - 75 Deg. 12 in Base Left Parallelogram
100316

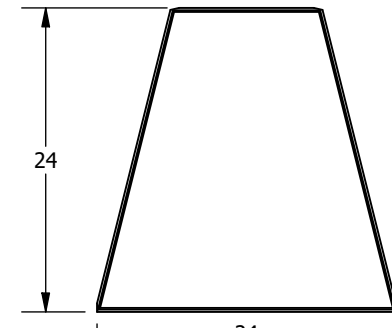

Ultima 9/16 Beveled Tegular - 75 Deg. 24 in Base Trapezoid
100310

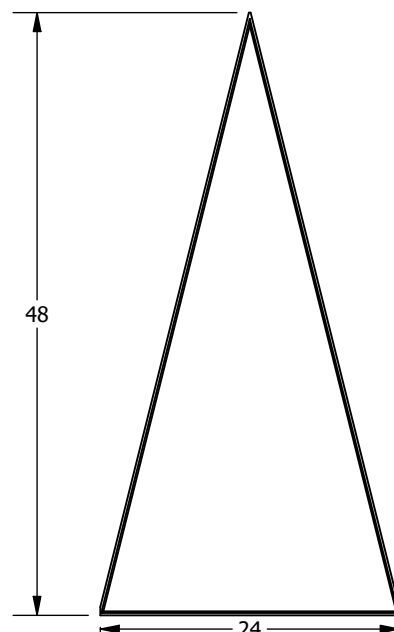

Ultima 9/16 Beveled Tegular - 75 Deg. 24 in Base Triangle
100304

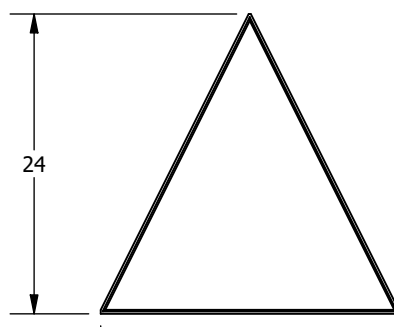

Ultima 9/16 Beveled Tegular - 60 Deg. 24 in Base Triangle
100301

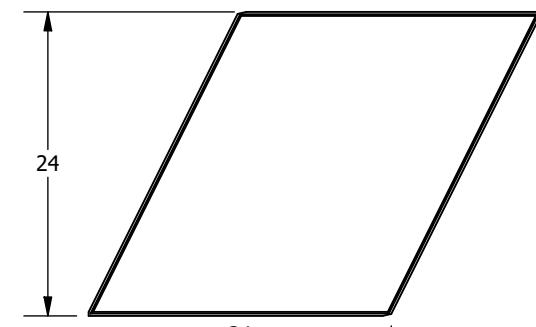

Ultima 9/16 Beveled Tegular - 60 Deg. 24 in Base Right Parallelogram
100313

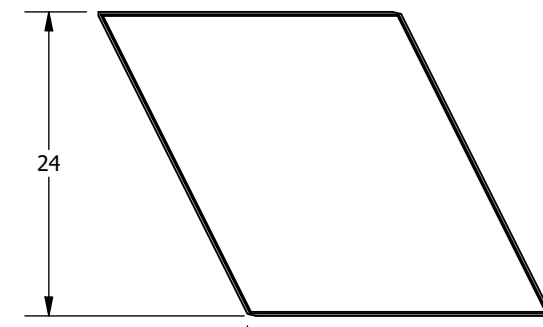

Ultima 9/16 Beveled Tegular - 60 Deg. 24 in Base Left Parallelogram
100314

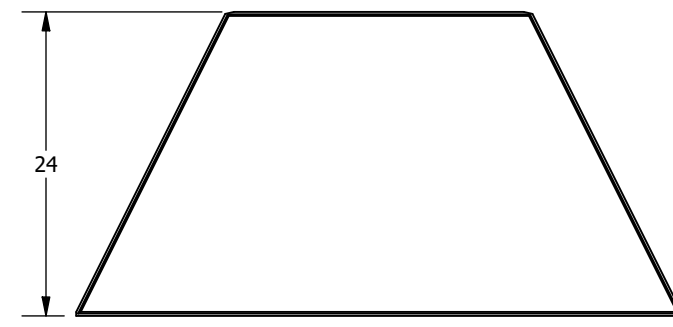

Ultima 9/16 Beveled Tegular - 60 Deg. 48 in Base Trapezoid
100309

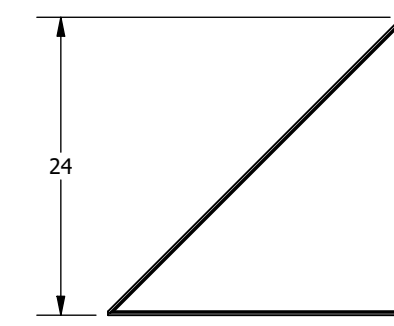

Ultima 9/16 Beveled Tegular - 45 Deg. 24 in Base Rt. Triangle
100307

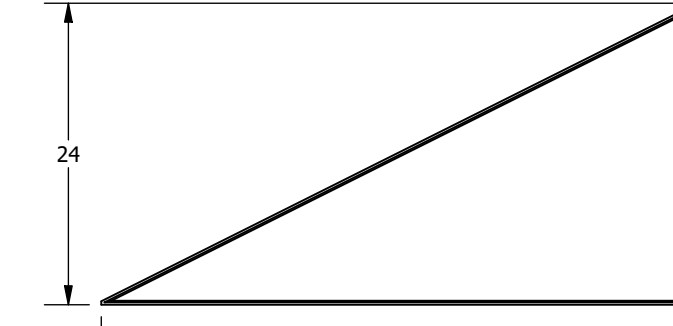

Ultima 9/16 Beveled Tegular - 60 Deg. 48 in Base Right Rt. Triangle
100306

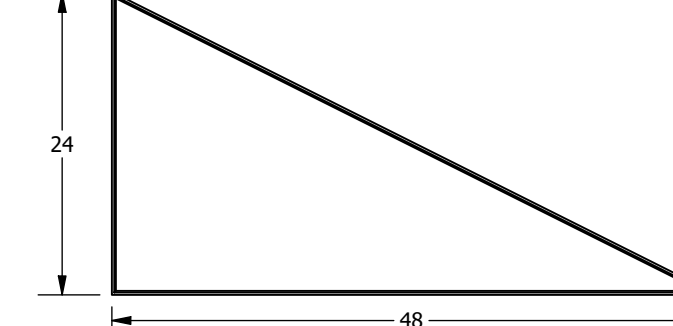

Ultima 9/16 Beveled Tegular - 60 Deg. 48 in Base Left Rt. Triangle
100305

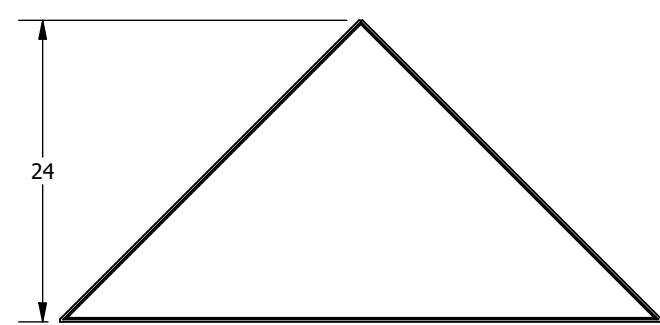

Ultima 9/16 Beveled Tegular - 45 Deg. 48 in Base Triangle
100300

NOTES:

- Views are from the face of the panel, and descriptions are based on these views
- Dimensions are nominal and reflect grid spacings
- Scale 1:15