

NOTES:  
 THE EXAMPLE LAYOUT AND CORRESPONDING BOM SHOWN ARE MEANT TO BE USED AS REFERENCE POINTS WHEN SPECIFYING A DESIGNFLEX SYSTEM.  
 IF YOU PLAN TO USE THE EXACT LAYOUT SHOWN, OR ANY VARIATION THEREOF, CONSIDER THE FOLLOWING NOTES:

- 1) DRAWING DETAILS SHOW A CEILING PLAN VIEW WHICH IS FROM A PLENUM POSITION LOOKING DOWN ONTO THE BACKSIDE OF THE CEILING SYSTEM. BOM LISTS DESCRIPTIONS THAT COORDINATE WITH THE DATA PAGES, AND THESE ITEM DESCRIPTIONS ARE BASED ON VIEWING THE FACE OF THE PRODUCTS.
- 2) ANGLE BRACKETS AND CORNER BRACKETS ARE INSTALLED AT STANDARD 6" OC ROUTE HOLE INCREMENTS ALONG THE MAIN BEAMS - ALL MAIN BEAMS ARE INSTALLED WITH ALIGNED ROUTE HOLES.
- 3) ANGLE BRACKETS USED WITHIN LAYOUTS HAVE SCREWS, WASHERS, AND NUTS INCLUDED WITH THEM FOR FASTENING TO MAIN BEAMS. IF CORNER BRACKETS ARE USED IN THE SYSTEM THEY WILL REQUIRE SCREWS THAT ARE NOT INCLUDED AND NEED TO BE SUPPLIED BY OTHERS.
- 4) SCREWS, RIVETS, AND OTHER GENERAL FASTENERS THAT ARE NOT INCLUDED IN BOM OR IN DETAILS BELOW, NEED TO BE SUPPLIED BY OTHERS. REFER TO INSTALLATION INSTRUCTIONS FOR DETAILS ON REQUIRED FASTENERS.
- 5) HANGER WIRE LOCATIONS SHOWN BELOW ARE ONLY SUGGESTIONS BASED ON EXAMPLE LAYOUT AND CAN BE MOVED IN ACCORDANCE WITH FOLLOWING REQUIREMENT - HANGER WIRES ARE REQUIRED ALONG MAINS WITHIN 24" OF THE WALL AND NO MORE THAN 48" O.C THEREAFTER.
- 6) CONDITIONS SHOWN ARE FOR NON-SEISMIC INSTALLATIONS (SEISMIC DESIGN CATEGORY A,B) - REFERENCE INSTALLATION INSTRUCTIONS FOR CONSIDERATIONS AND REQUIREMENTS FOR SEISMIC INSTALLATIONS.
- 7) DETAILS BELOW AND BOM ARE SUBJECT TO CHANGES AT THE PERIMETER BASED ON THE LAYOUT (LINEAR FEET OF PERIMETER, FULL SIZE VS. CUT PANELS, BORDER PANEL INSTALLATION METHOD).
- 8) 7800 WALL ANGLE PERIMETER SHOWN BELOW. REFERENCE INSTALLATION INSTRUCTIONS FOR DETAILS ON ALTERNATIVE PERIMETER SOLUTIONS.
- 9) BOM DOES NOT ACCOUNT FOR THE USE OF SCRAP OR EXCESS MATERIAL CUT FROM OTHER ITEMS.
- 10) REFER TO MASTER PARTS SHEET, PANEL SHEET, AND INSTALLATION INSTRUCTIONS ILLUSTRATIONS SHEET FOR SPECIFIC DETAIL VIEWS AND DIAGRAMS OF ALL PARTS AND PIECES LISTED IN BOM.

SH-0016-1 BILL OF MATERIALS				
ITEM	QTY	STOCK NUMBER	DESCRIPTION	
1	16	7800	Angle Molding	
2	76	7500/7501	12" ID/HD Suprafine Main Beam	
3	180	XL7520	2" Suprafine Cross Tee	
4	160	XM756048	Suprafine 60 Deg. Cross Tee - 48in MBS	
5	40	XM7548	Suprafine Perimeter Cross Tee - 48in MBS	
6	342	75CB60R	Suprafine 60 Deg. Right Corner Bracket	
7	38	BERC2	2" Beam End Retaining Clip	
8	38	XTAC	Cross Tee Adapter Clip	
9	76	PAC	Perimeter Angle Clip	
10	400	100007	Lyra 9/16" Square Tegular - 60 Deg. 48 in Base Right Rt. Triangle	
11	209	7891	12 Gauge Hanger Wire (Qty. = number of min. hanging point locations)	

EXAMPLE LAYOUT AND BOM SHOWN WITH LYRA PANELS AND SUPRAFINE SUSPENSION SYSTEM

PANEL PRODUCT FAMILIES COMPATIBLE WITH THIS LAYOUT:  
 LYRA, CALLA, OPTIMA, AND ULTIMA

SUSPENSION SYSTEMS COMPATABLE WITH THIS LAYOUT:  
 SUPRAFINE ID/HD

**SIDE A** - REPRESENTS A BORDER CONDITION UTILIZING A SINGLE GRID MEMBER CONNECTION TO THE PERIMETER

**SIDE B** - REPRESENTS A BORDER CONDITION UTILIZING A SINGLE GRID MEMBER CONNECTION OR MULTIPLE GRID MEMBER CONNECTIONS TO THE PERIMETER

REFERENCE INSTALLATION INSTRUCTIONS FOR FURTHER DETAILS ON HOW THESE BORDER CONDITIONS ARE INSTALLED

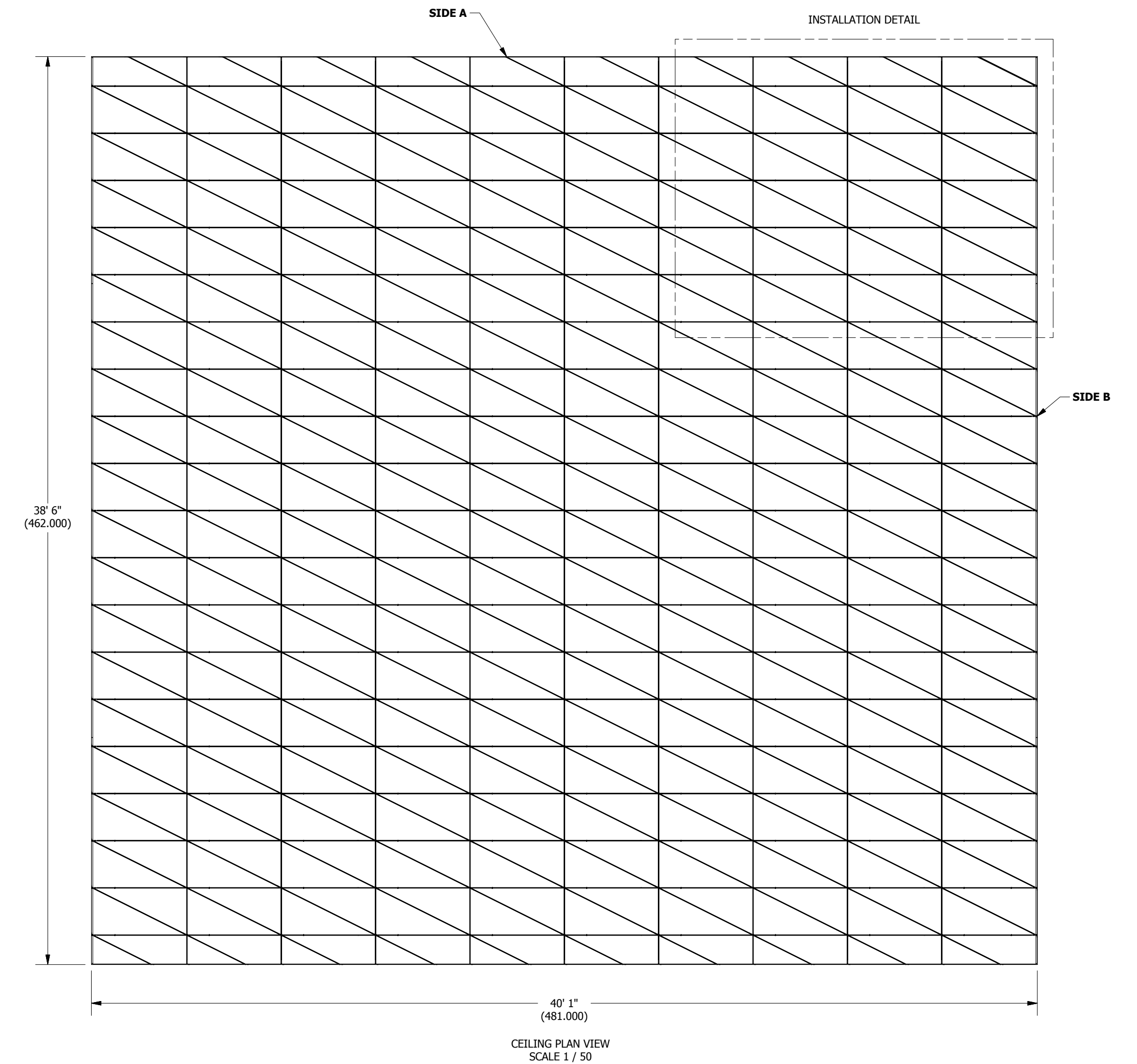
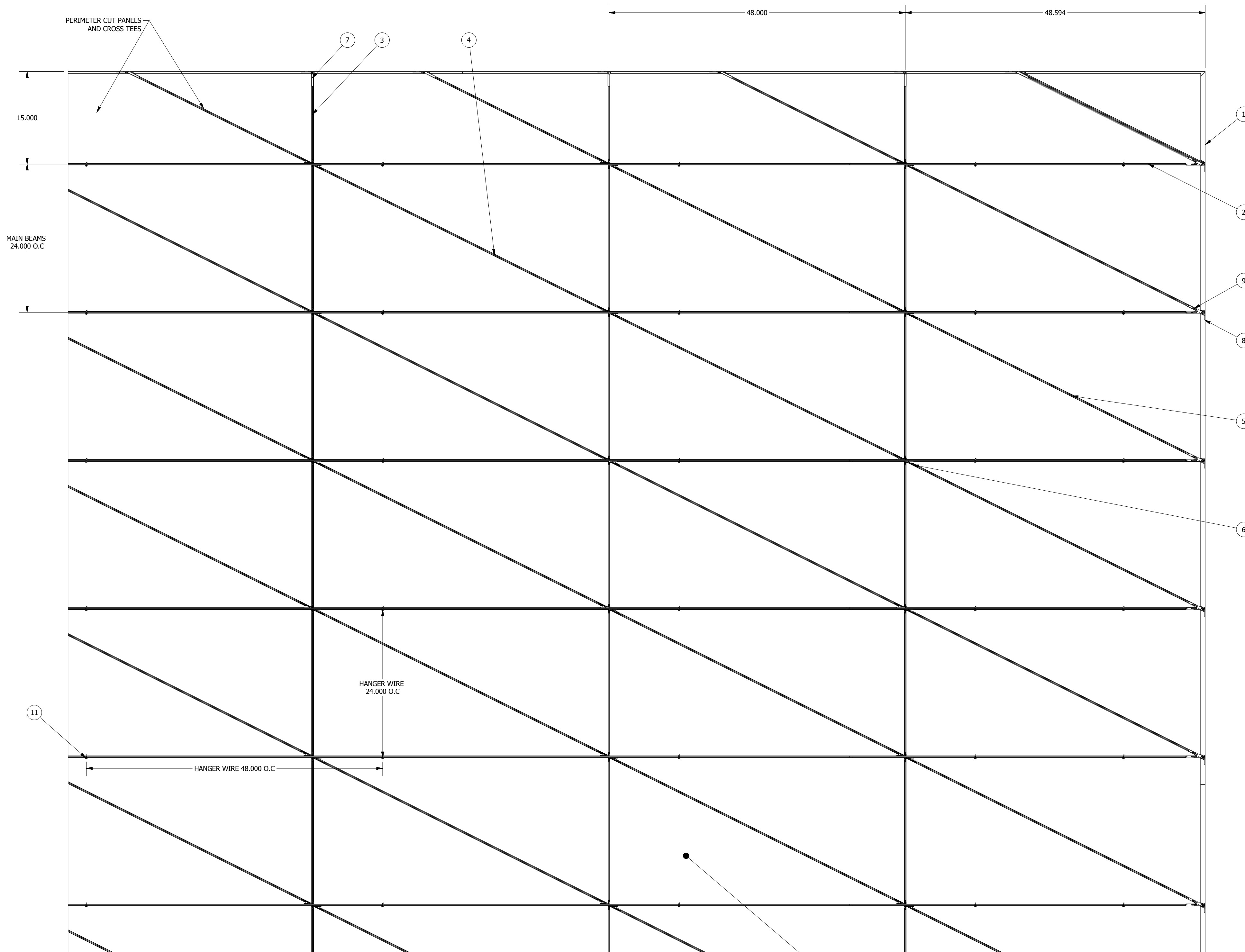

INSTALLATION DETAIL  
 SCALE 1 / 10

10



These drawings show typical conditions which the Armstrong products depicted are installed. They are not a substitute for an architect's or engineer's plan and do not reflect the unique requirements of local building codes, laws, statutes, ordinances, rules and regulations (Legal Requirements) that may be applicable for a particular installation. Armstrong does not warrant, and assumes no liability for the accuracy or completeness of the drawings for a particular installation or their fitness for a particular purpose. The user is advised to consult with a duly licensed architect or engineer in the particular locale of the installation to assure compliance with all legal requirements. Armstrong is not licensed to provide professional architecture or engineering design services.

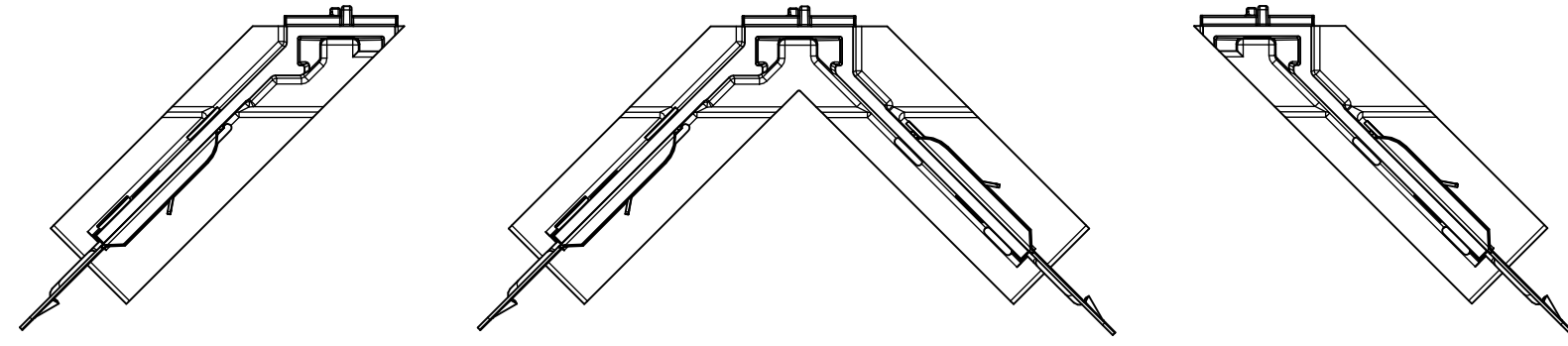

BP75AB45L Suprafine  
45° Left Angle Bracket

BP75AB45D Suprafine  
45° Double Angle Bracket

BP75AB45R Suprafine  
45° Right Angle Bracket

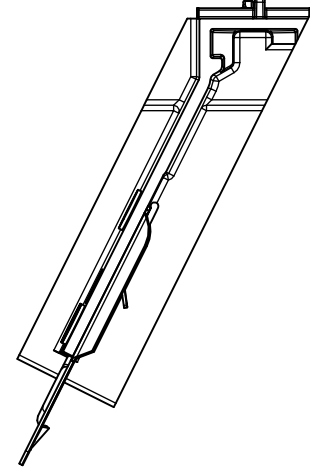

BP75AB60L Suprafine  
60° Left Angle Bracket

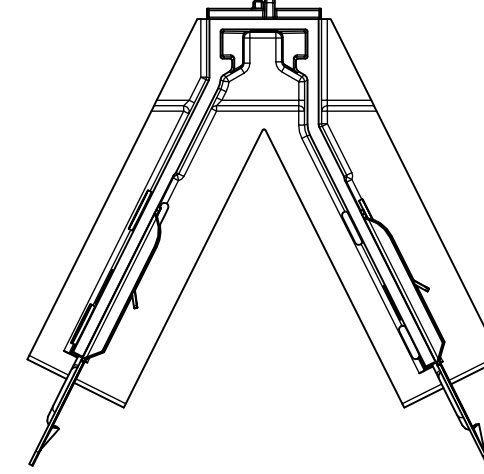

BP75AB60D Suprafine  
60° Double Angle Bracket

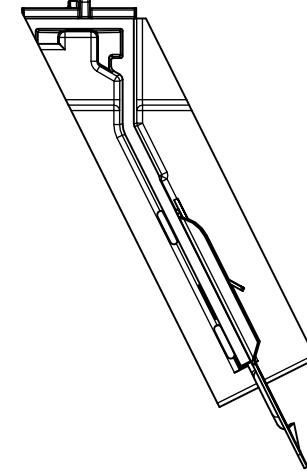

BP75AB60R Suprafine  
60° Right Angle Bracket

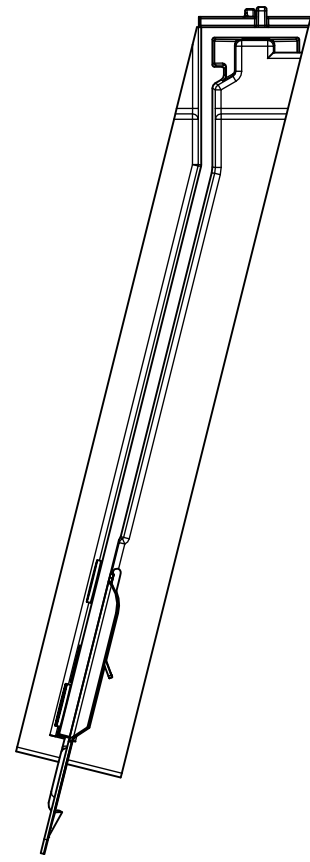

BP75AB75L Suprafine  
75° Left Angle Bracket

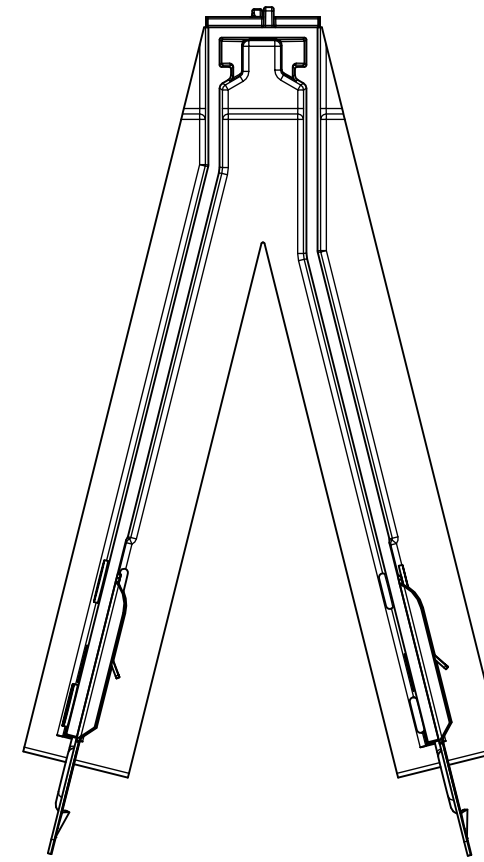

BP75AB75D Suprafine  
75° Double Angle Bracket

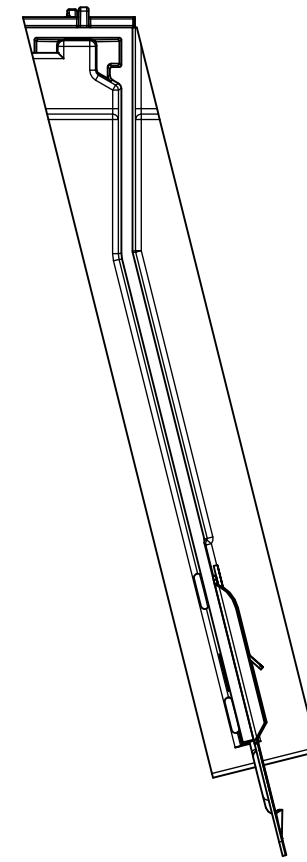

BP75AB75R Suprafine  
75° Right Angle Bracket

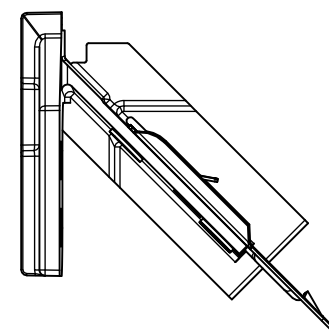

BP75CB45 Suprafine  
45° Corner Bracket

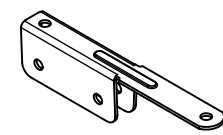

BPPAC  
Perimeter Angle Clip  
SCALE 1 / 2

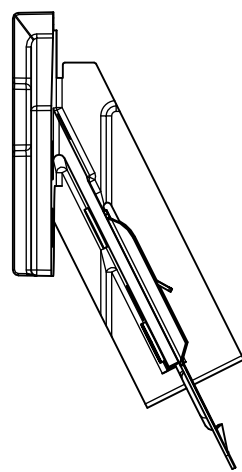

BP75CB60L Suprafine  
60° Left Corner Bracket

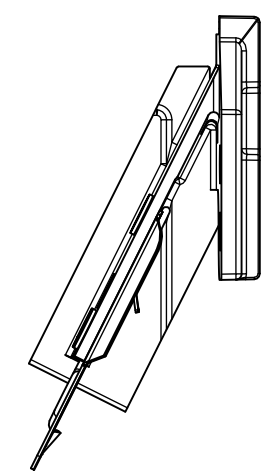

BP75CB60R Suprafine  
60° Right Corner Bracket

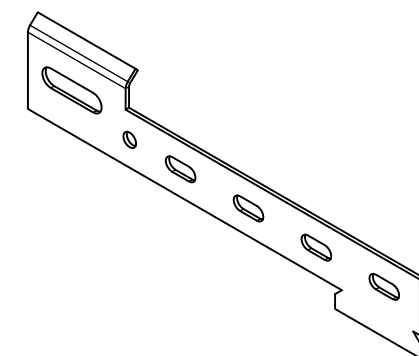

BPPCC  
Axiom Perimeter Corner Clip  
SCALE 1 / 2

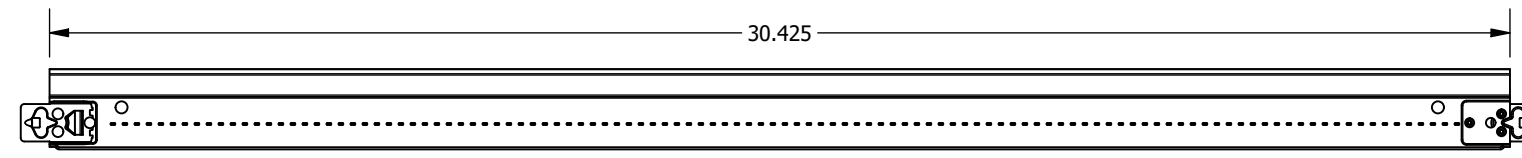

BPM754524 Suprafine  
45° Cross Tee - 24" MBS  
SCALE 1 / 4

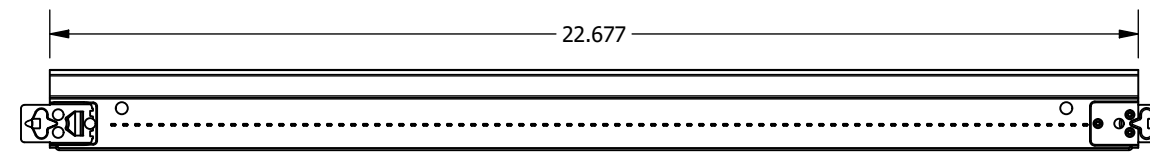

BPM756024 Suprafine  
60° Cross Tee - 24" MBS  
SCALE 1 / 4

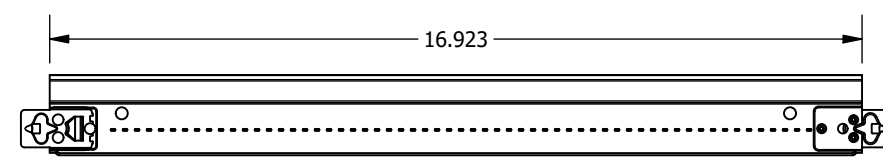

BPM757524 Suprafine  
75° Cross Tee - 24" MBS  
SCALE 1 / 4

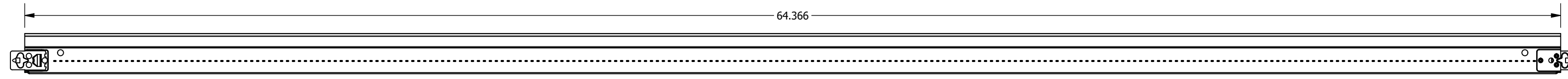

BPM754548 Suprafine  
45° Cross Tee - 48" MBS  
SCALE 1 / 4

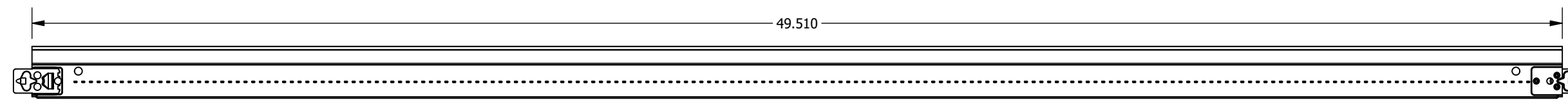

BPM756048 Suprafine  
60° Cross Tee - 48" MBS  
SCALE 1 / 4

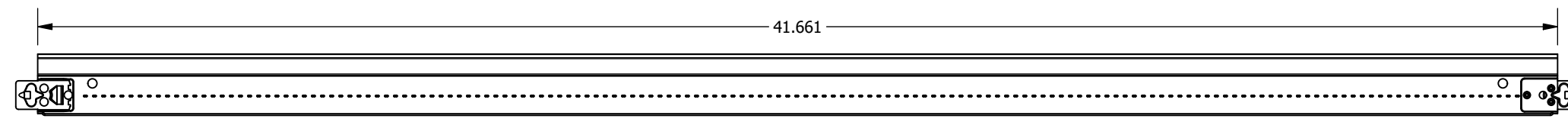

BPM757548 Suprafine  
75° Cross Tee - 48" MBS  
SCALE 1 / 4

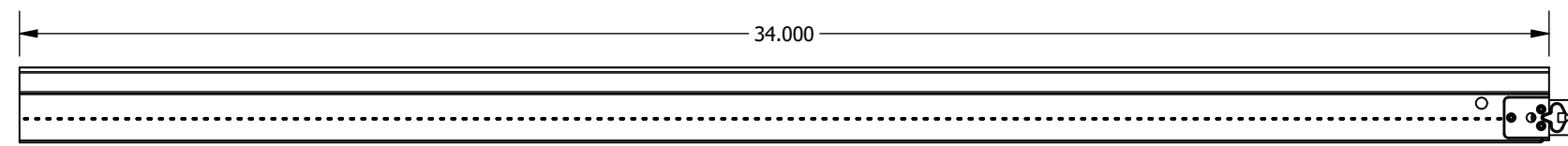

BPM7524 Suprafine  
Perimeter Cross Tee - 24" MBS  
SCALE 1 / 4

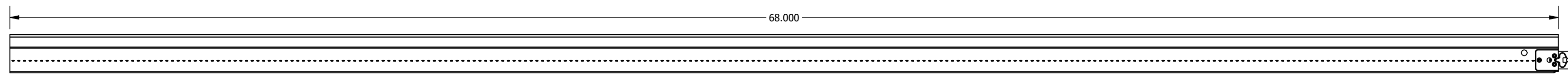

BPM7548 Suprafine  
Perimeter Cross Tee - 48" MBS  
SCALE 1 / 4

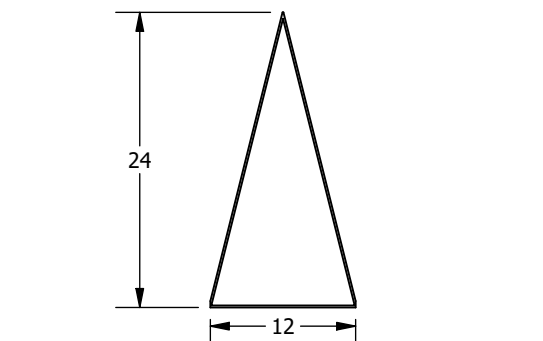

Lyra 9/16" Square Tegular - 75 Deg. 12 in Base Triangle  
100004

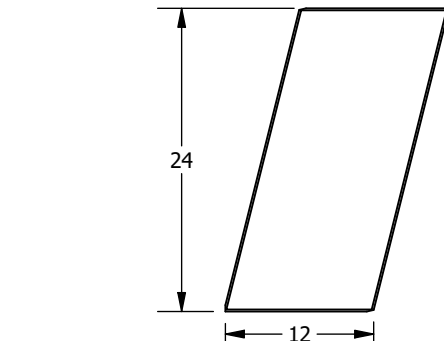

Lyra 9/16" Square Tegular - 75 Deg. 12 in Base Right Parallelogram  
100020

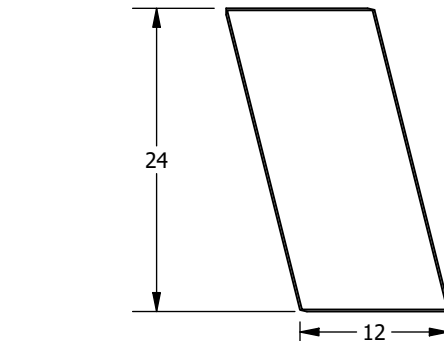

Lyra 9/16" Square Tegular - 75 Deg. 12 in Base Left Parallelogram  
100021

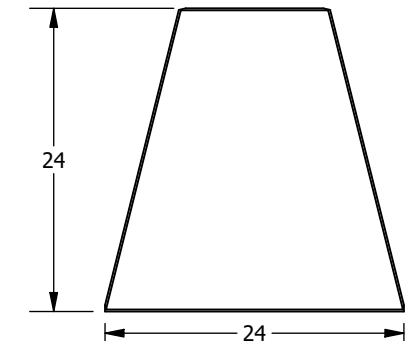

Lyra 9/16" Square Tegular - 75 Deg. 24 in Base Trapezoid  
100012

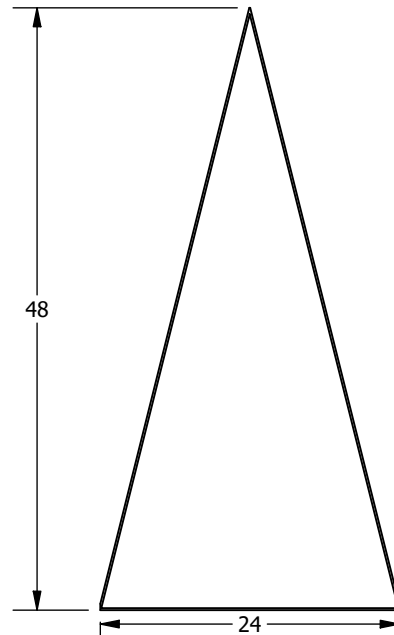

Lyra 9/16" Square Tegular - 75 Deg. 24 in Base Triangle  
100005

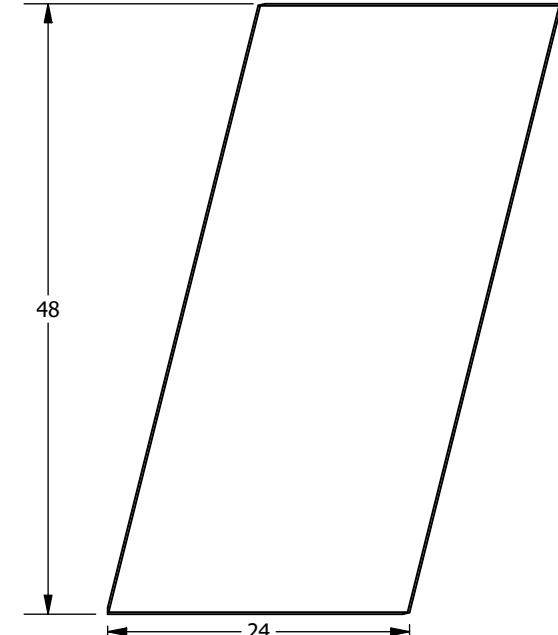

Lyra 9/16" Square Tegular - 75 Deg. 24 in Base Right Parallelogram  
100022

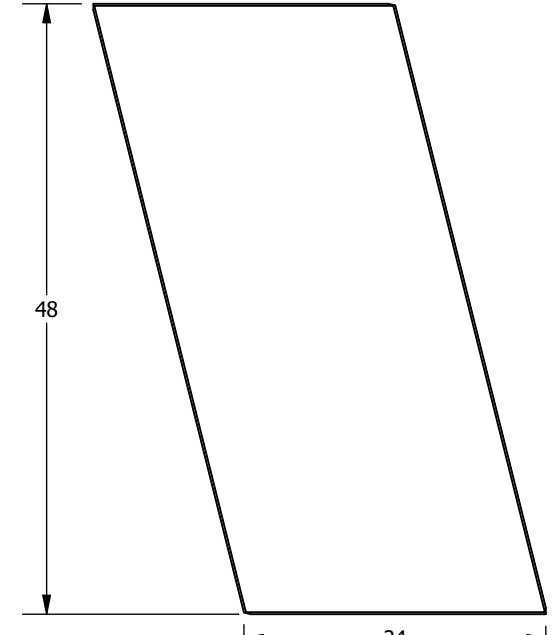

Lyra 9/16" Square Tegular - 75 Deg. 24 in Base Left Parallelogram  
100023

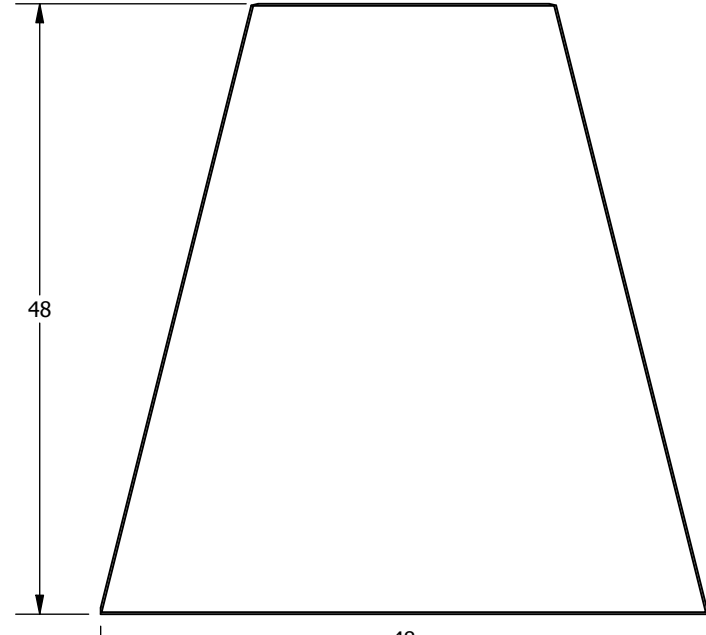

Lyra 9/16" Square Tegular - 75 Deg. 48 in Base Trapezoid  
100013

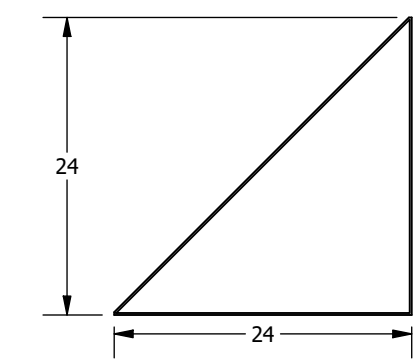

Lyra 9/16" Square Tegular - 45 Deg. 24 in Base Rt. Triangle  
100008

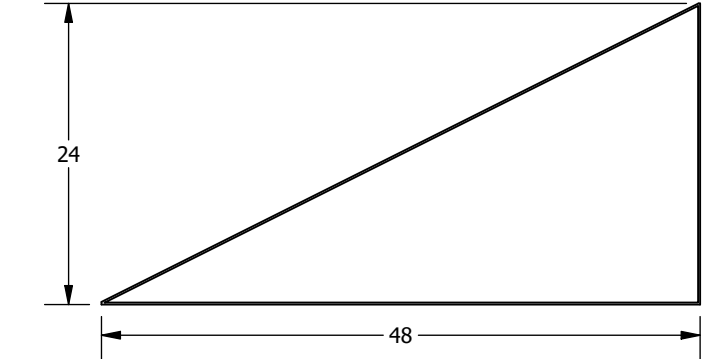

Lyra 9/16" Square Tegular - 60 Deg. 48 in Base Right Rt. Triangle  
100007

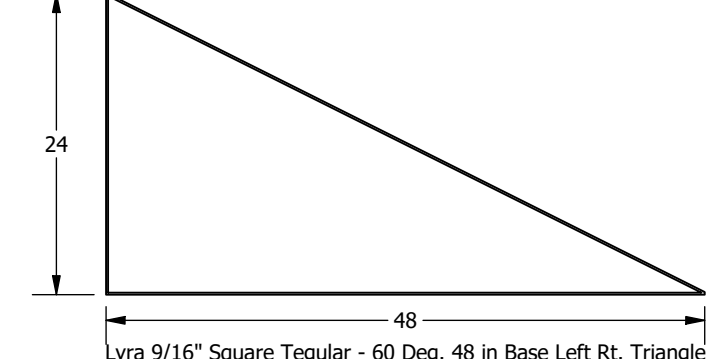

Lyra 9/16" Square Tegular - 60 Deg. 48 in Base Left Rt. Triangle  
100006

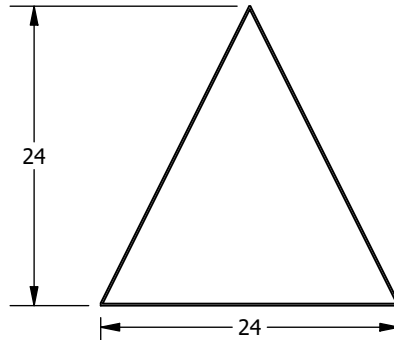

Lyra 9/16" Square Tegular - 60 Deg. 24 in Base Triangle  
100002

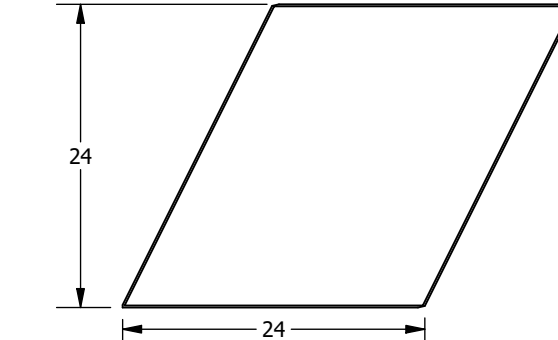

Lyra 9/16" Square Tegular - 60 Deg. 24 in Base Right Parallelogram  
100016

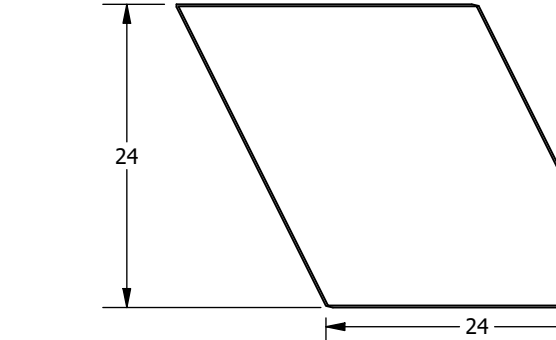

Lyra 9/16" Square Tegular - 60 Deg. 24 in Base Left Parallelogram  
100017

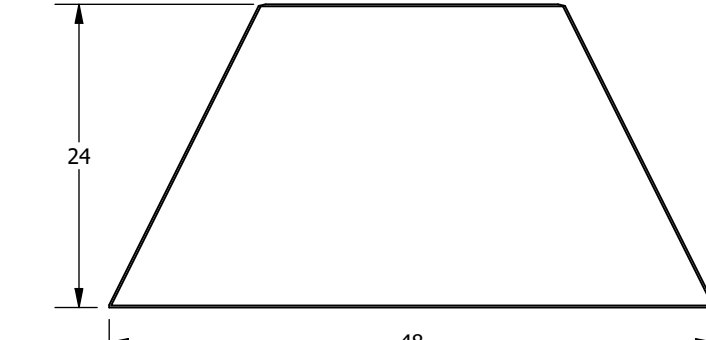

Lyra 9/16" Square Tegular - 60 Deg. 48 in Base Trapezoid  
100011

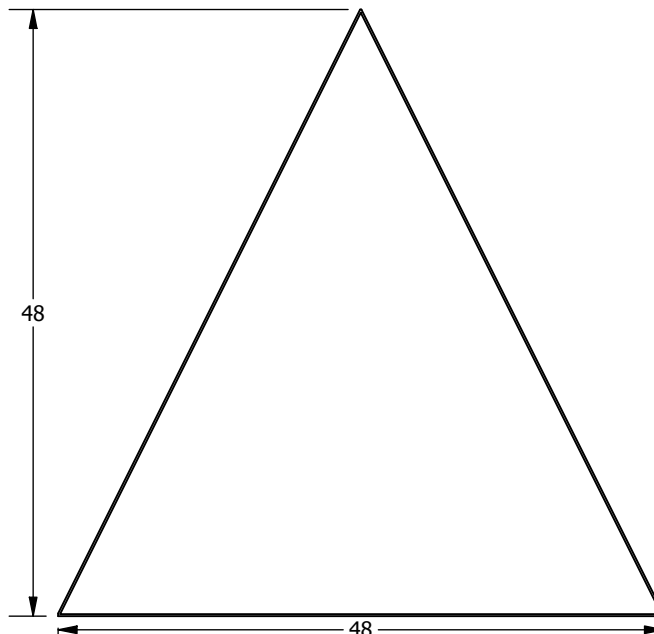

Lyra 9/16" Square Tegular - 60 Deg. 48 in Base Triangle  
100003

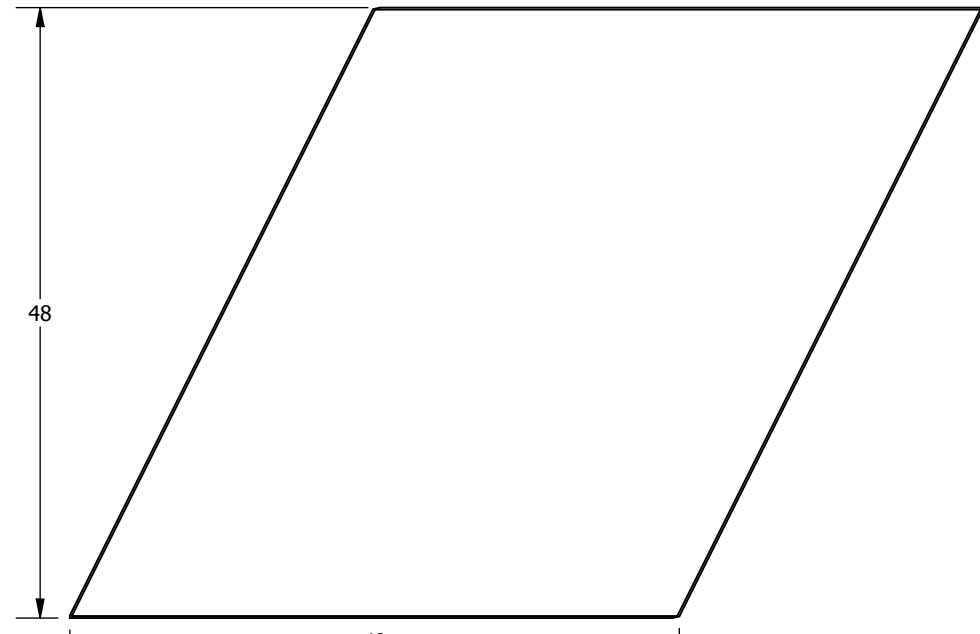

Lyra 9/16" Square Tegular - 60 Deg. 48 in Base Right Parallelogram  
100018

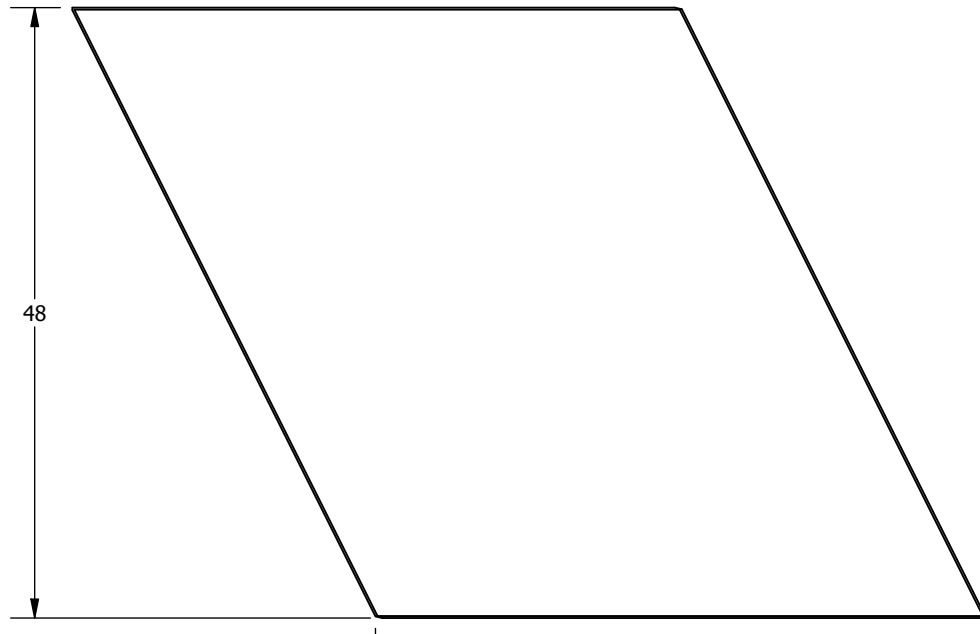

Lyra 9/16" Square Tegular - 60 Deg. 48 in Base Left Parallelogram  
100019

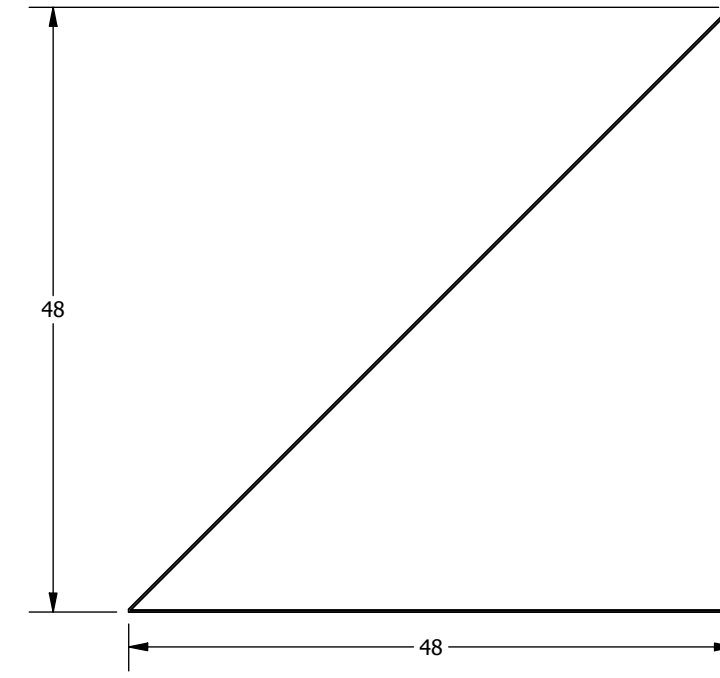

Lyra 9/16" Square Tegular - 45 Deg. 48 in Base Rt. Triangle  
100009

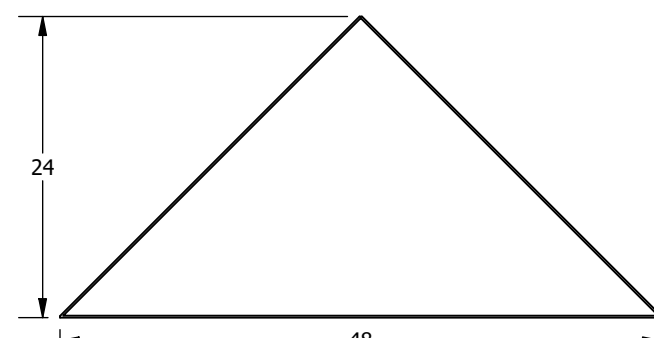

Lyra 9/16" Square Tegular - 45 Deg. 48 in Base Triangle  
100001

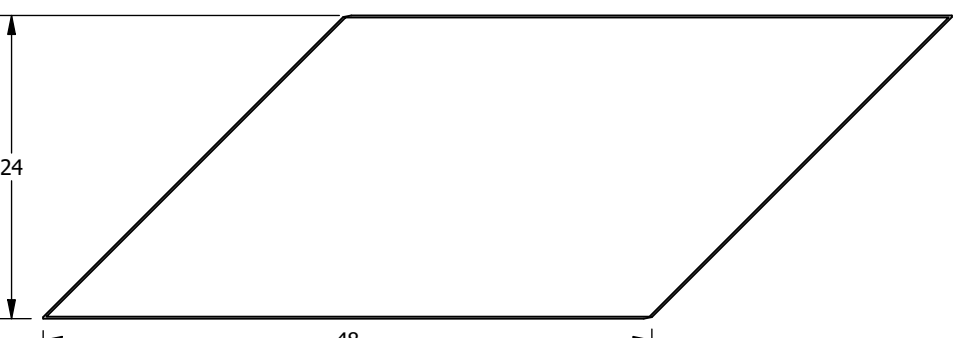

Lyra 9/16" Square Tegular - 45 Deg. 48 in Base Right Parallelogram  
100014

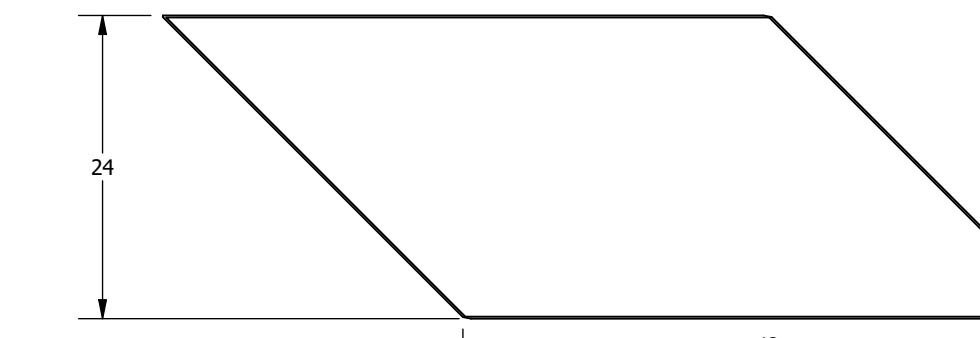

Lyra 9/16" Square Tegular - 45 Deg. 48 in Base Left Parallelogram  
100015

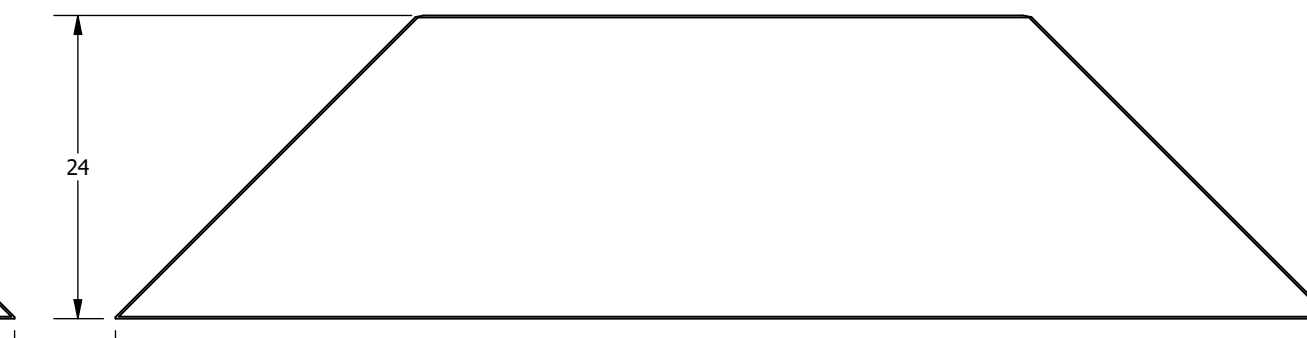

Lyra 9/16" Square Tegular - 45 Deg. 96 in Base Trapezoid  
100010

NOTES:  
1. Views are from the face of the panel, and descriptions are based on these views  
2. Dimensions are nominal and reflect grid spacings  
3. Scale 1:15

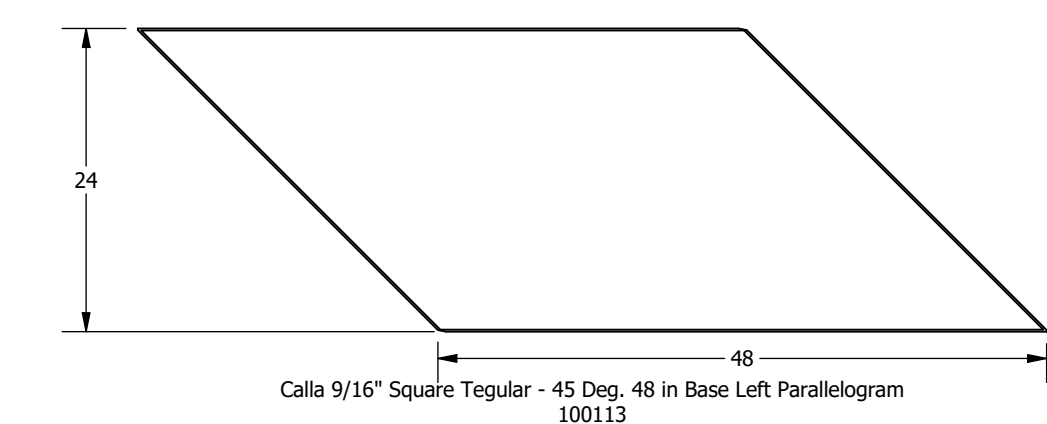
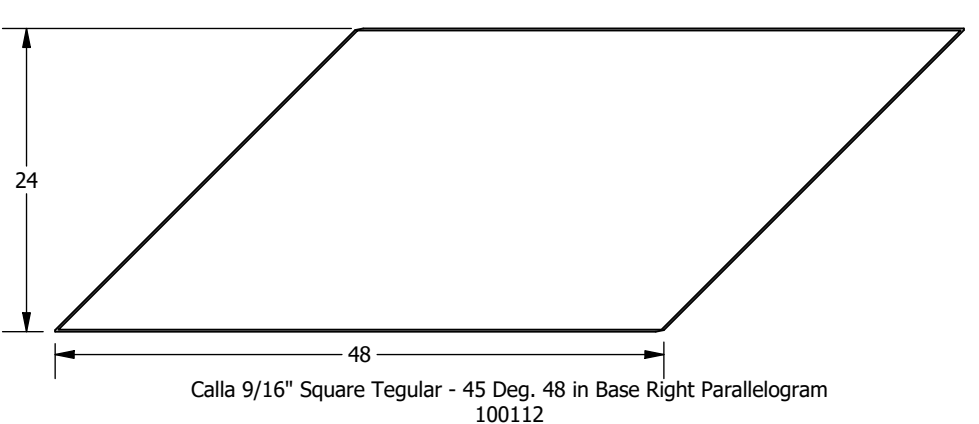
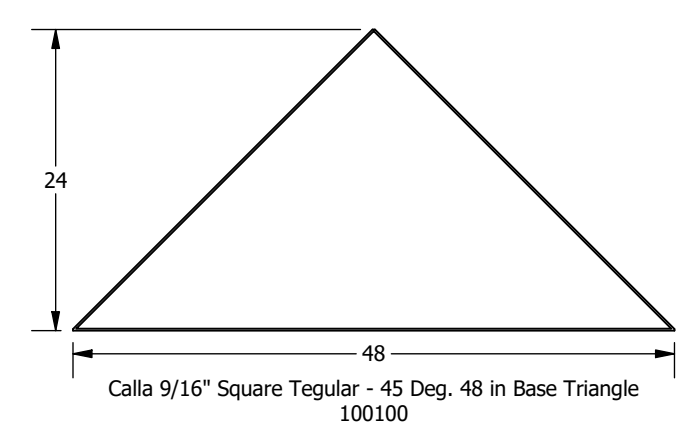
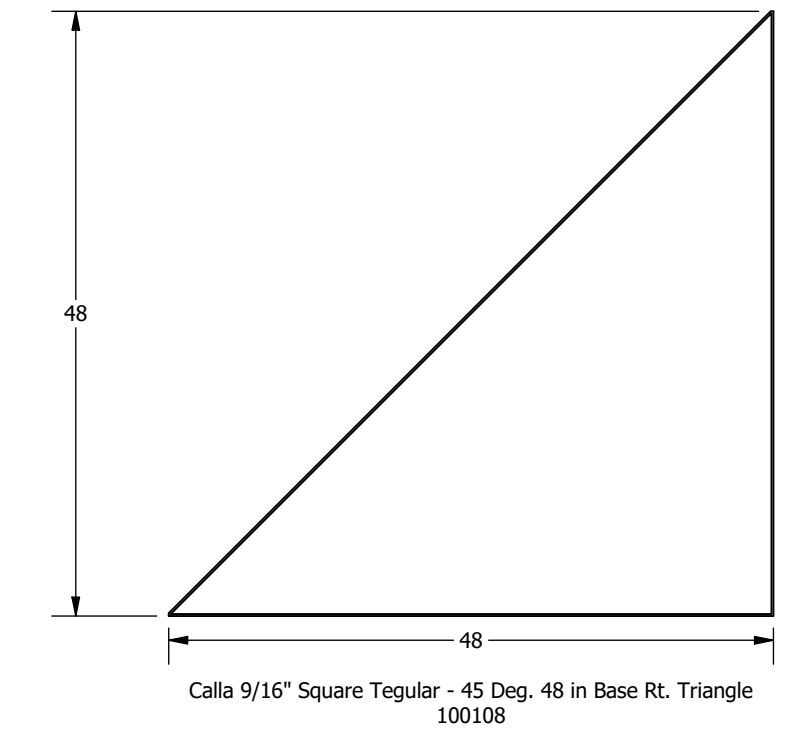
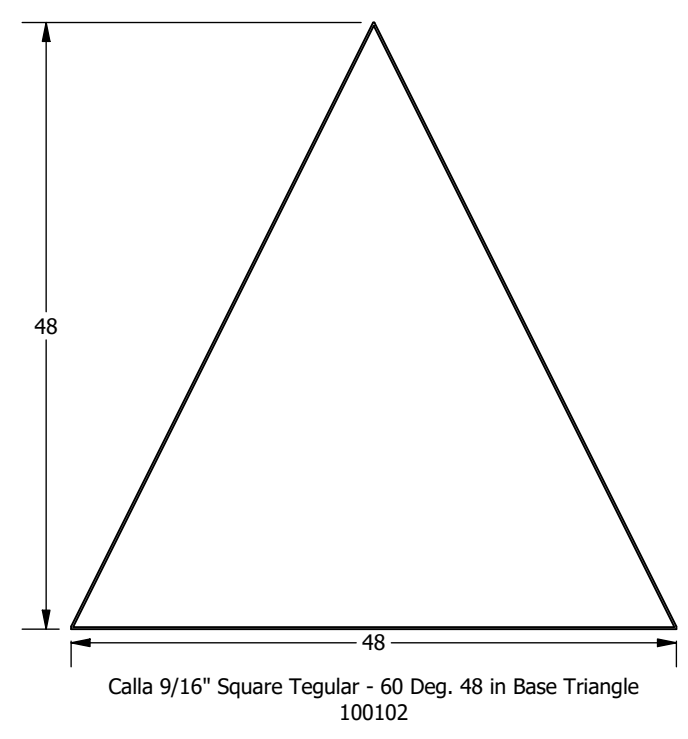
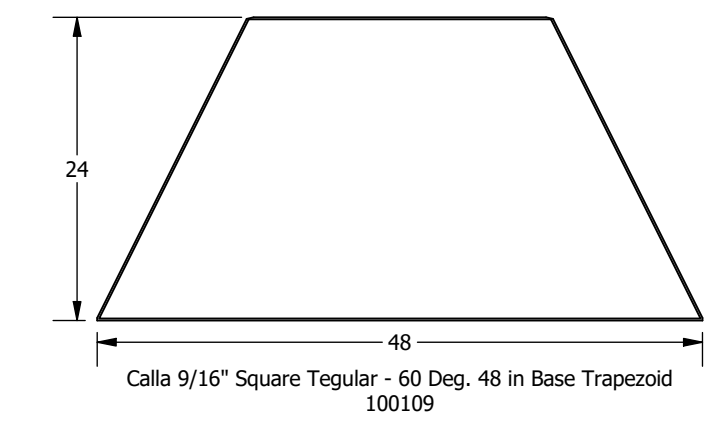
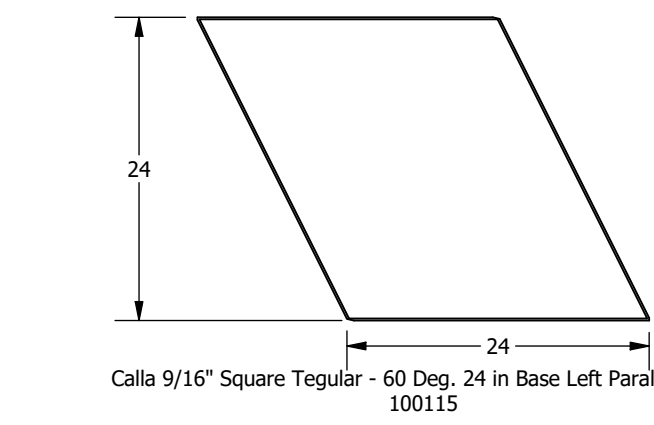
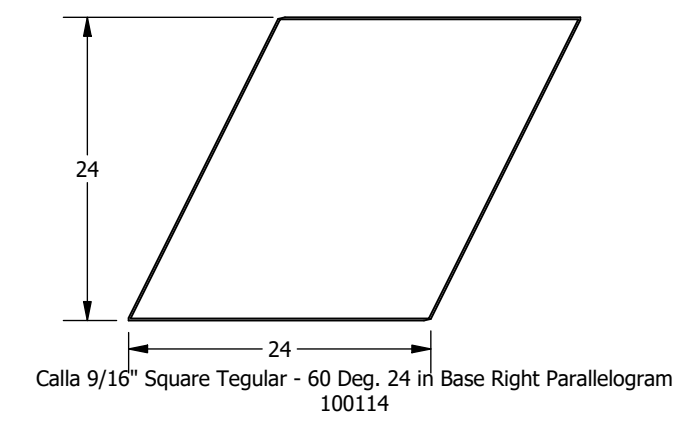
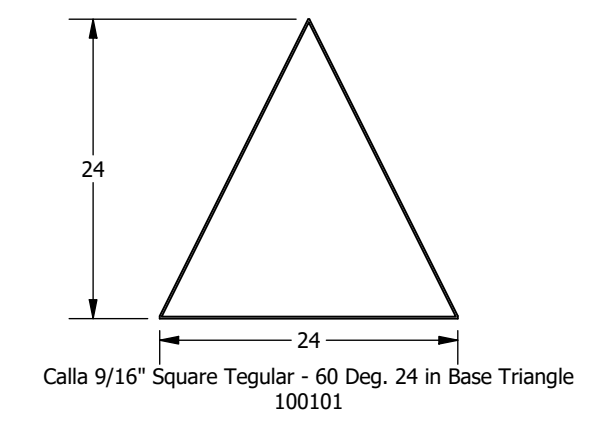
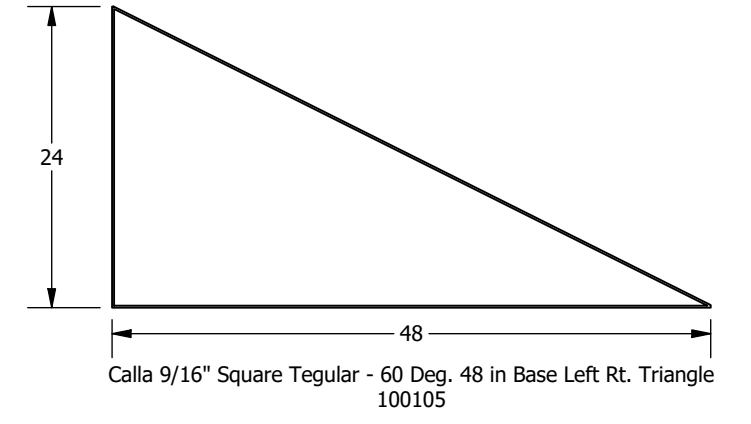
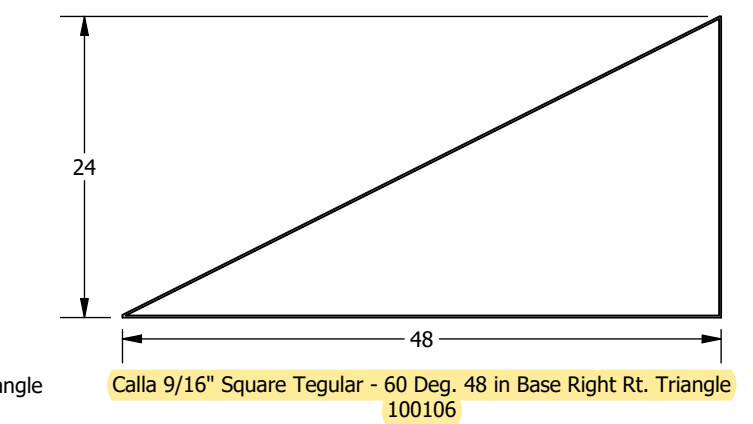
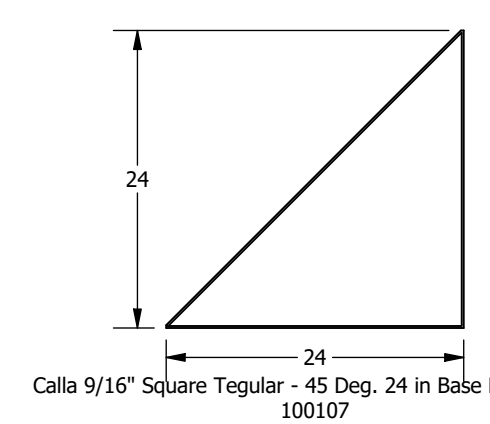
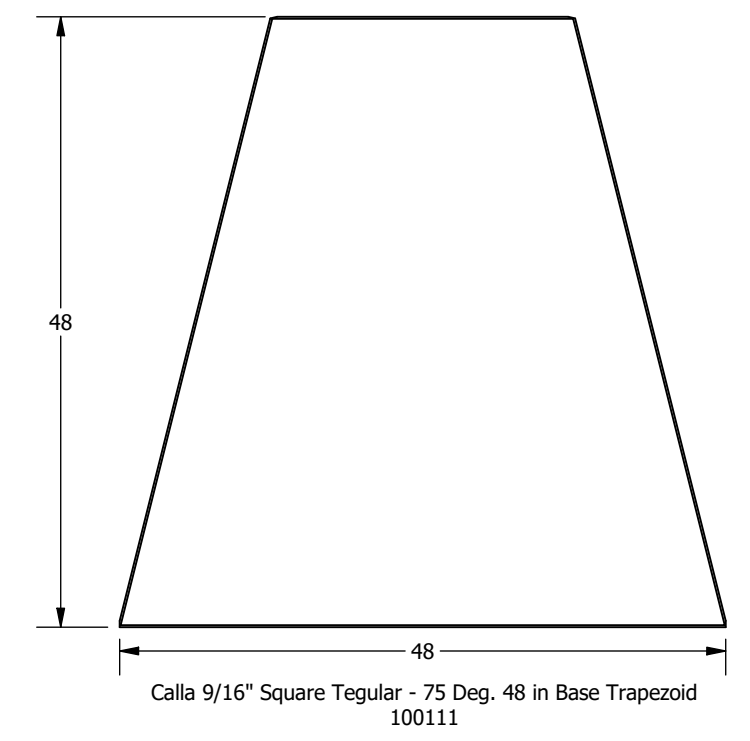
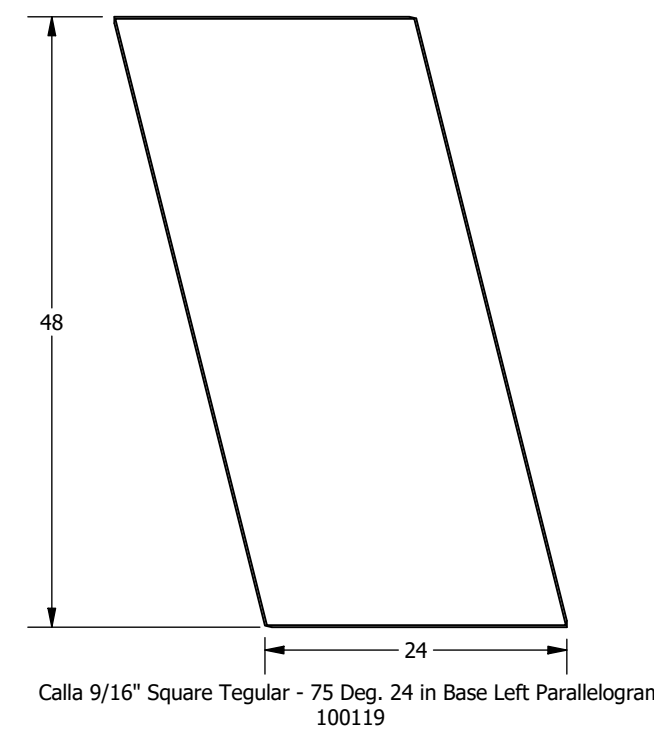
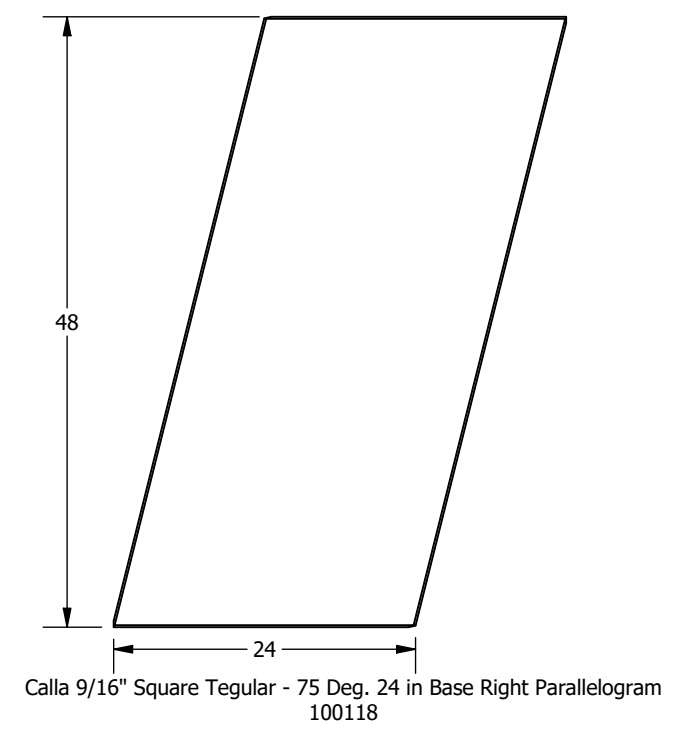
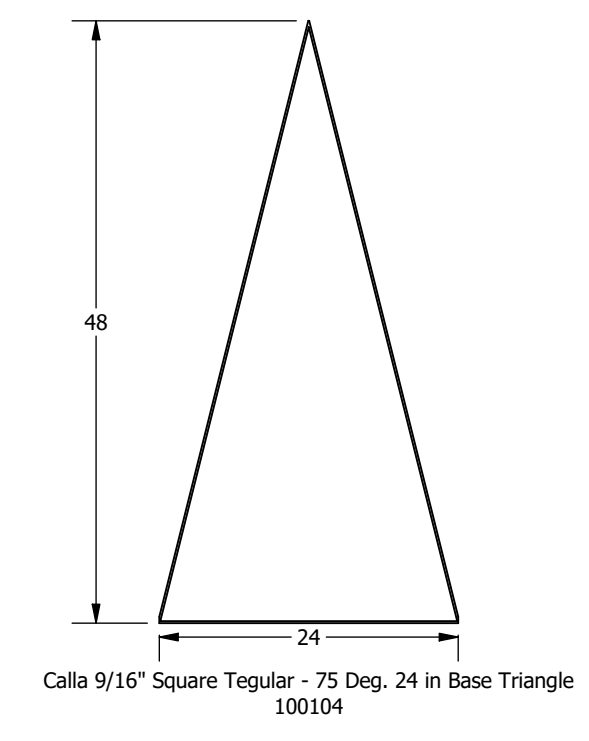
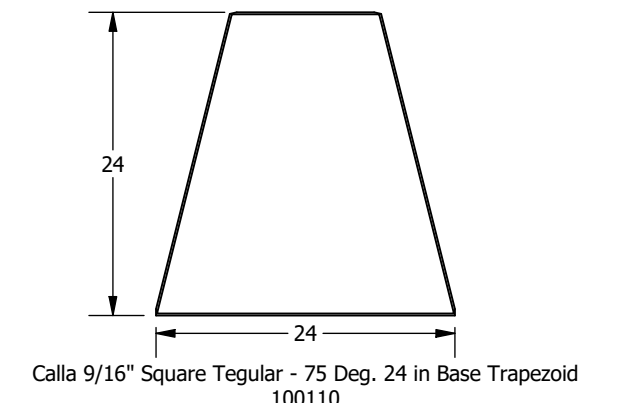
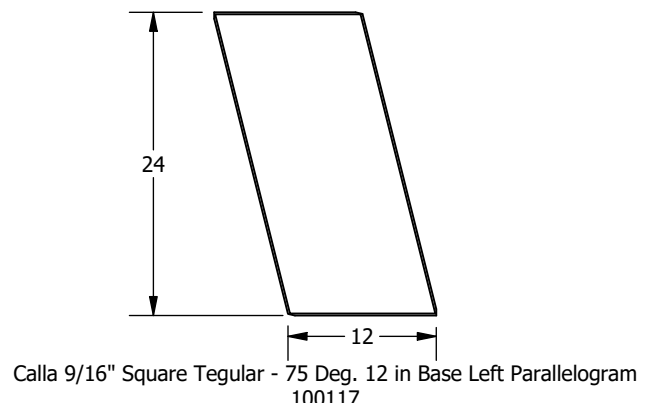
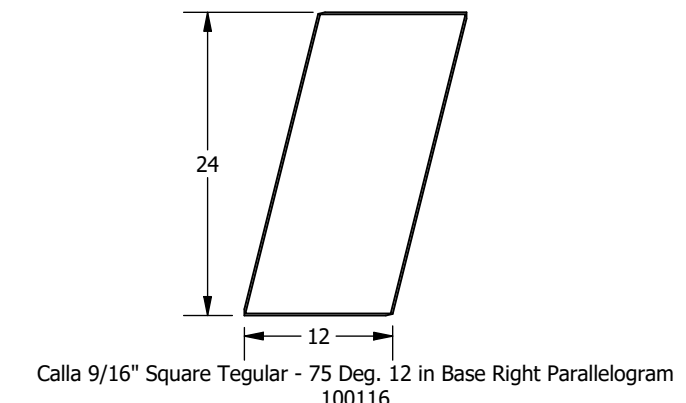
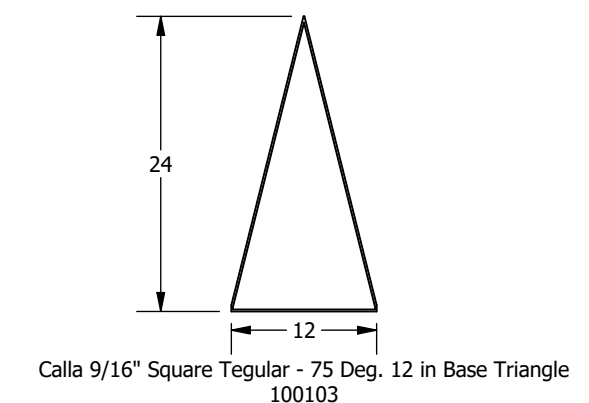

NOTES:  
1. Views are from the face of the panel, and descriptions are based on these views  
2. Dimensions are nominal and reflect grid spacings  
3. Scale 1:15



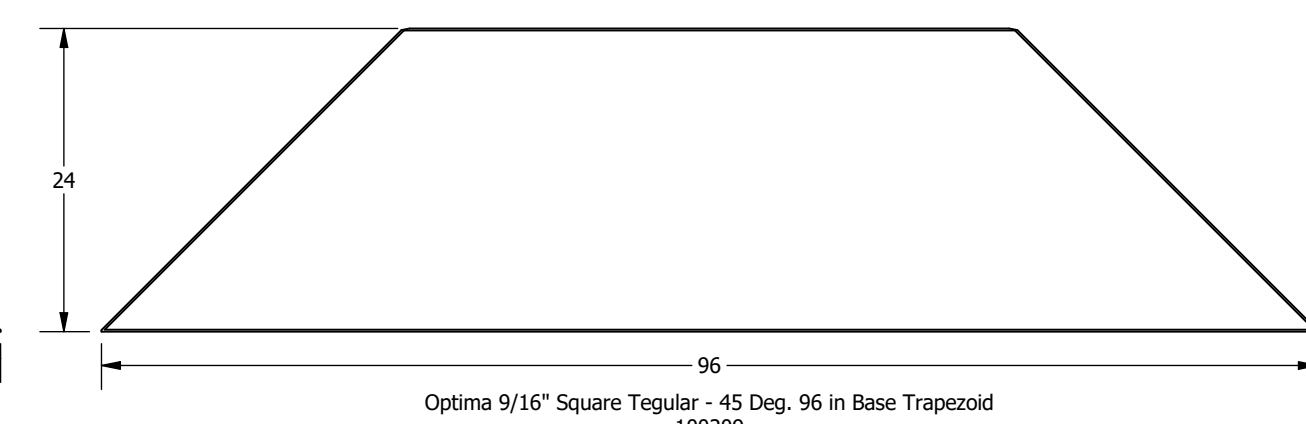
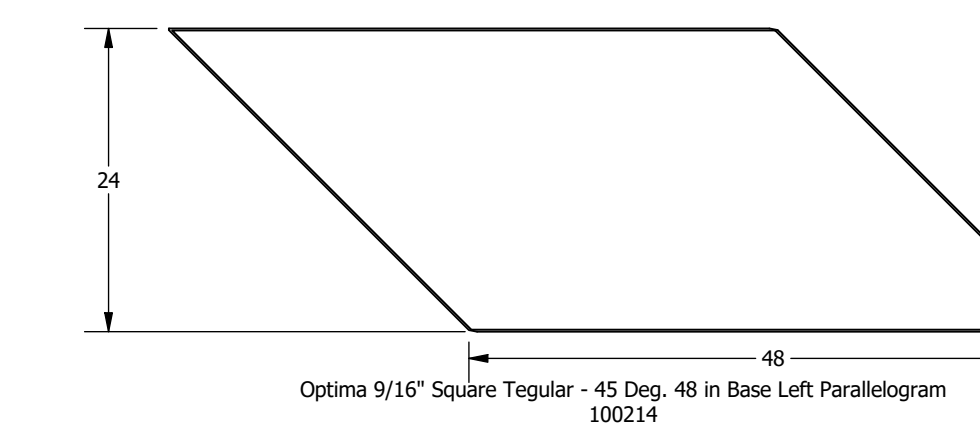
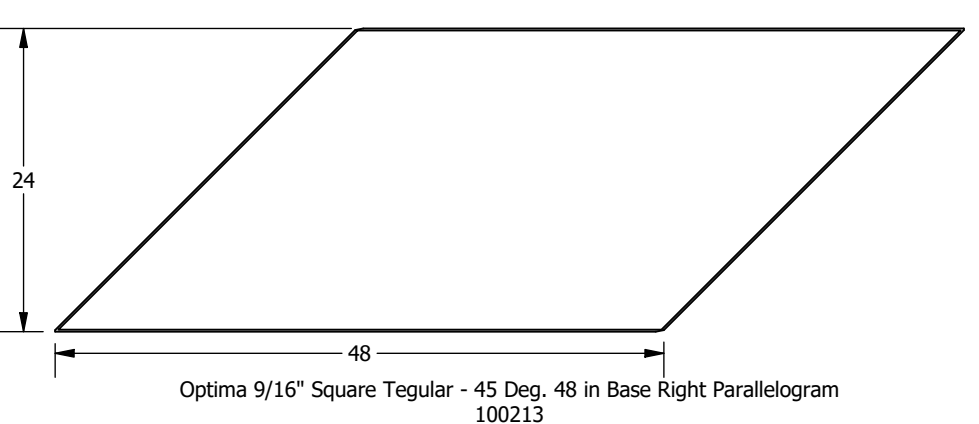
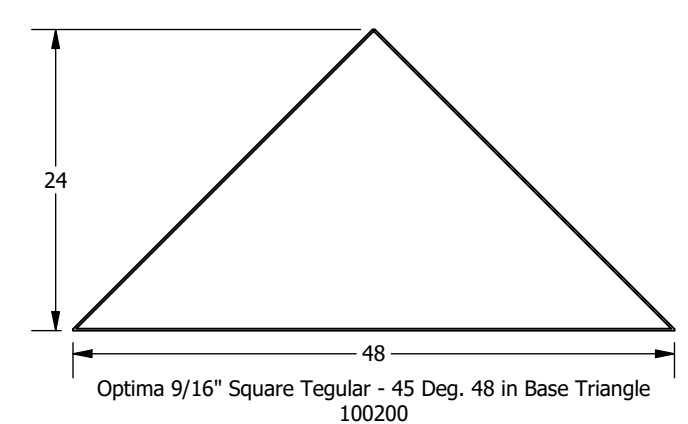
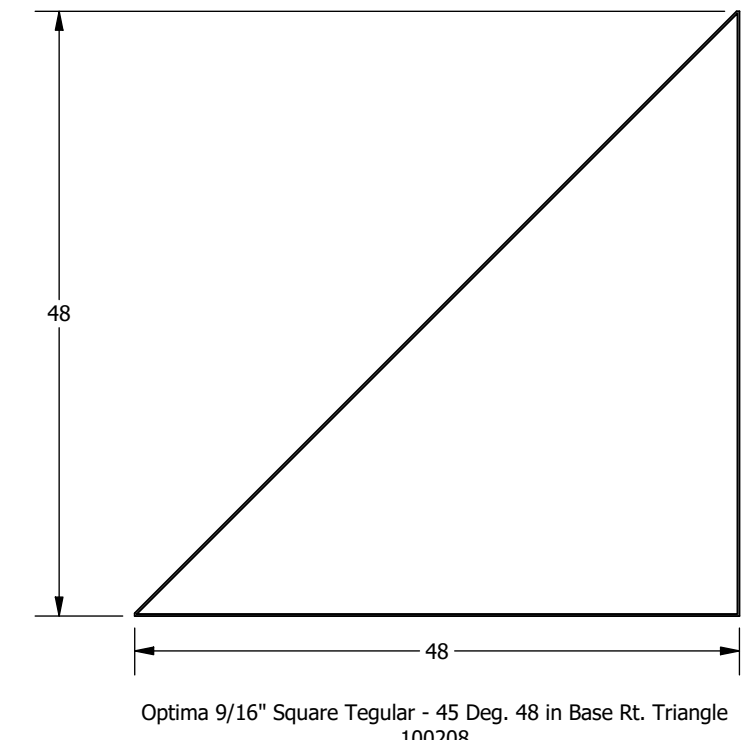
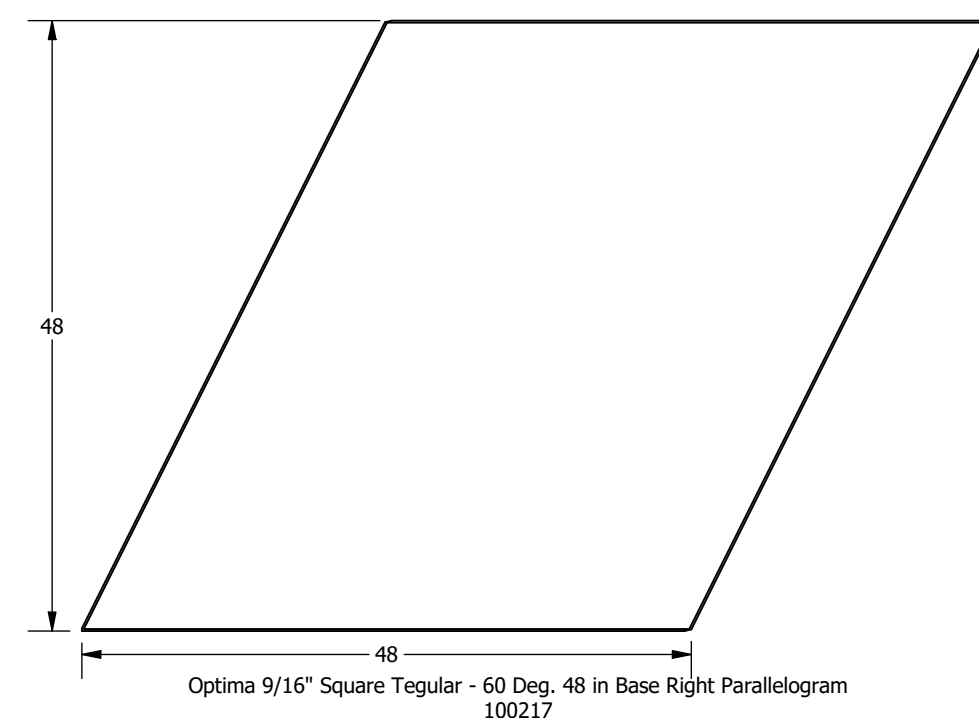
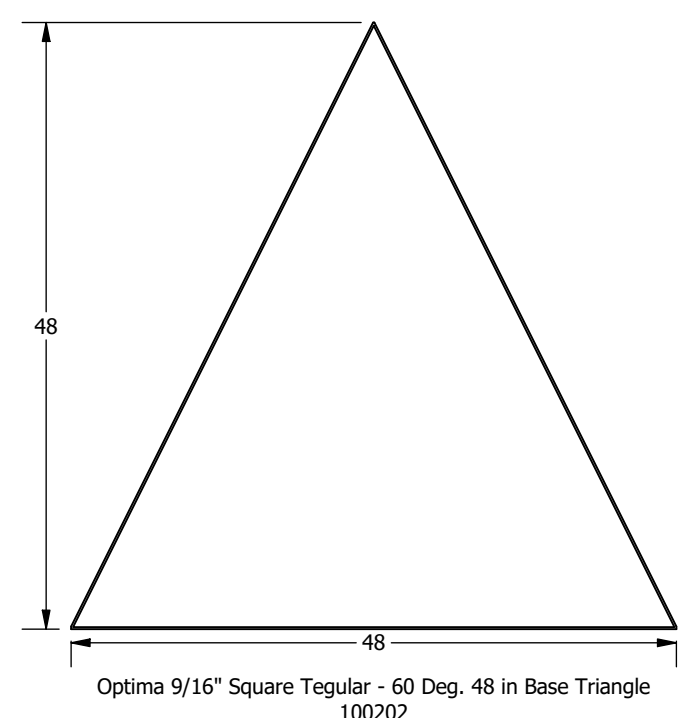
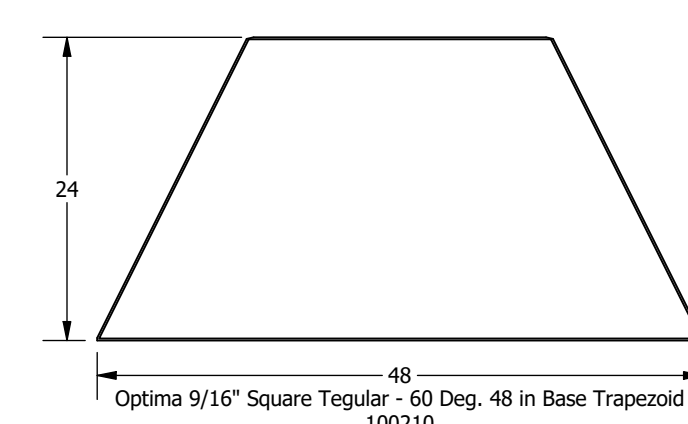
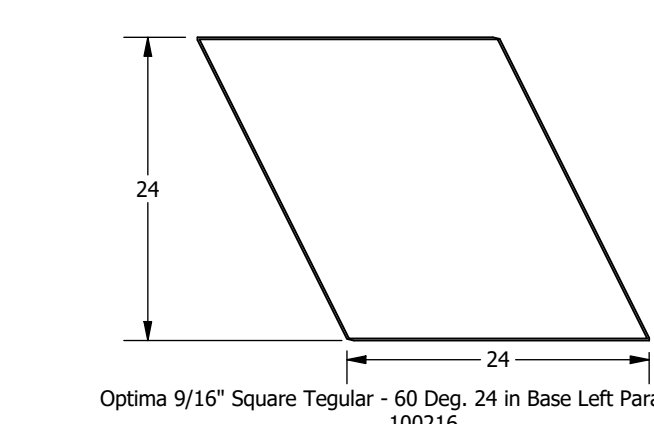
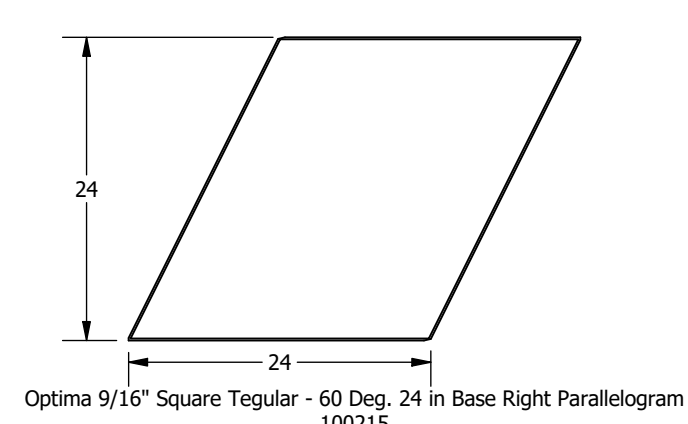
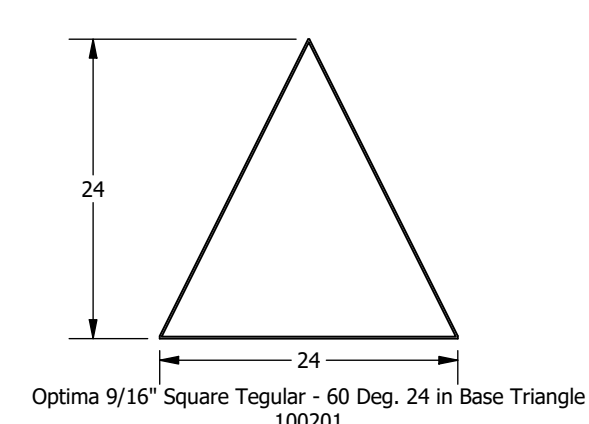
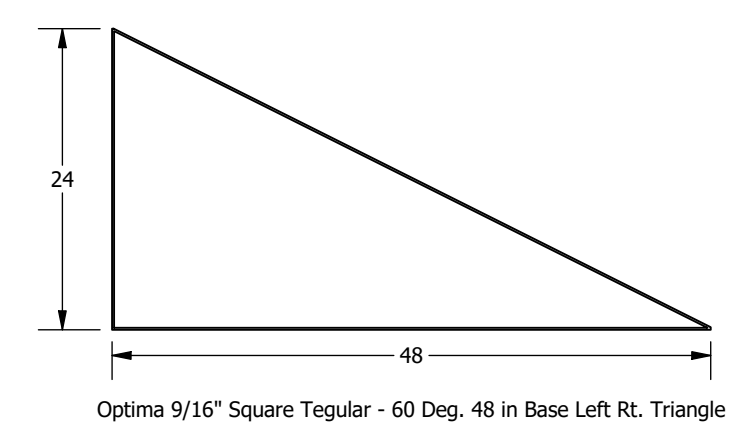
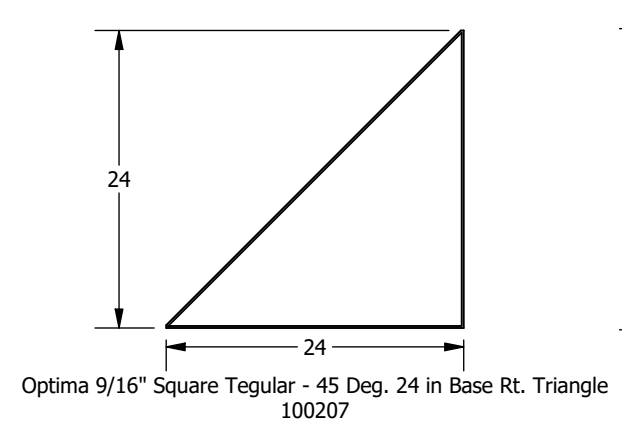
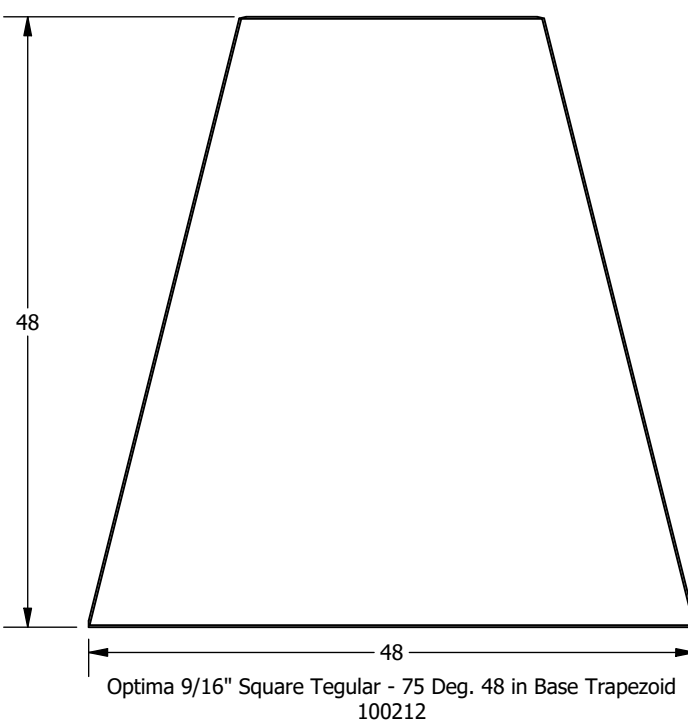
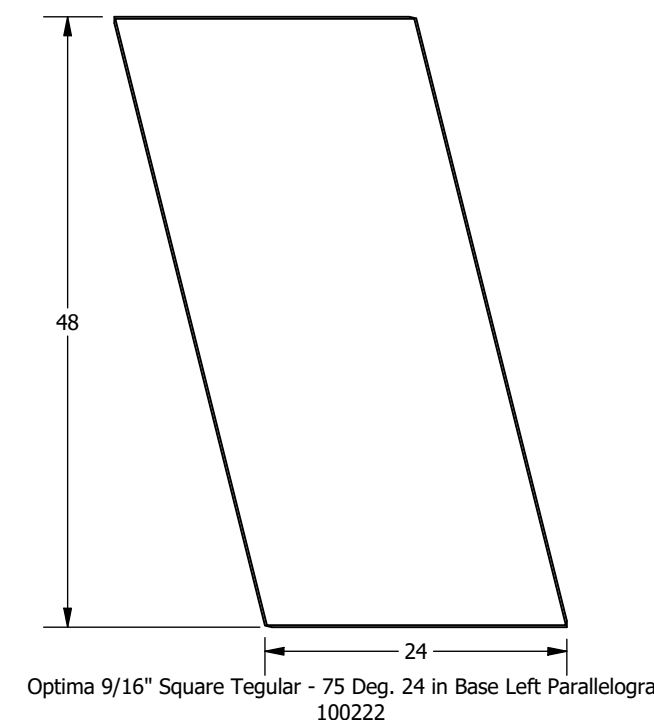
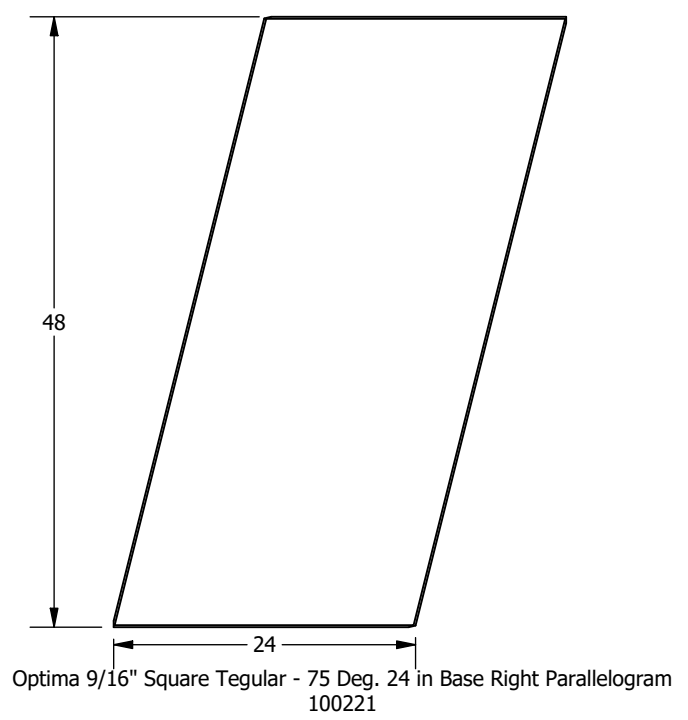
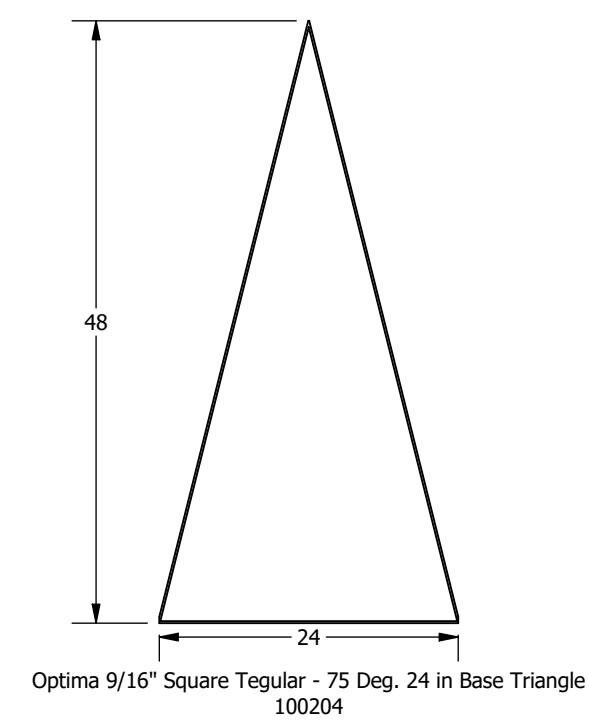
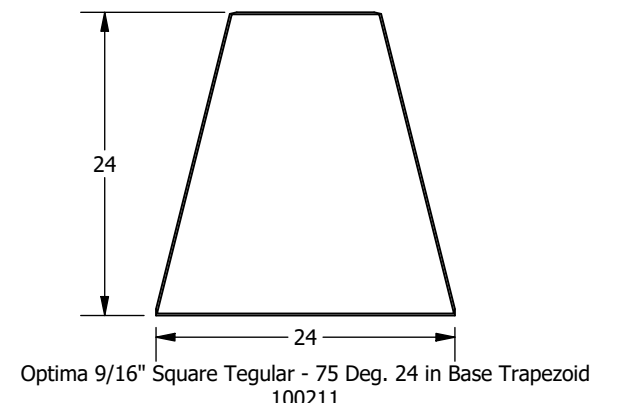
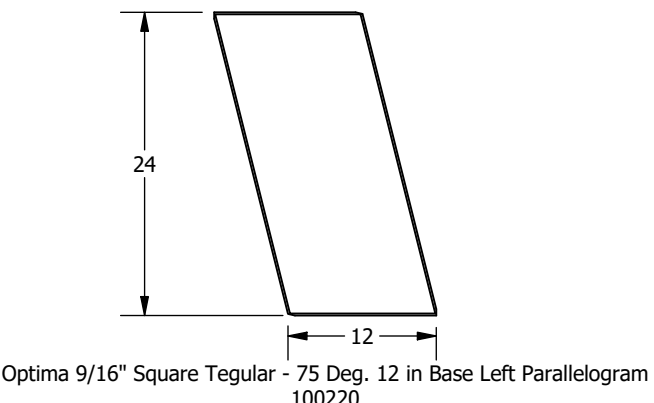
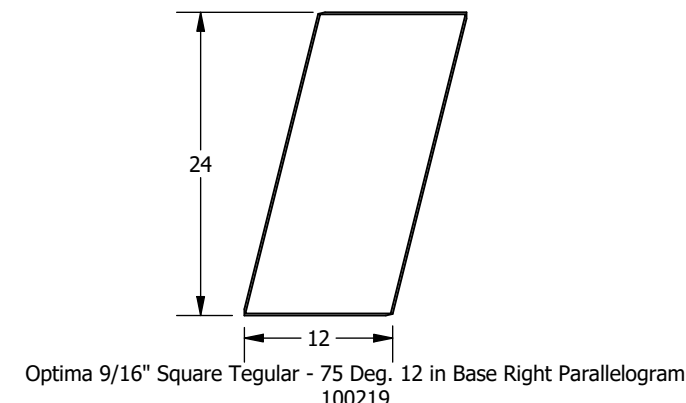
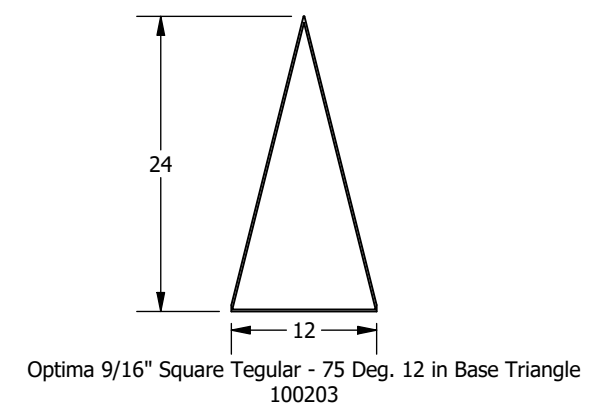

NOTES:  
1. Views are from the face of the panel, and descriptions are based on these views  
2. Dimensions are nominal and reflect grid spacings  
3. Scale 1:15

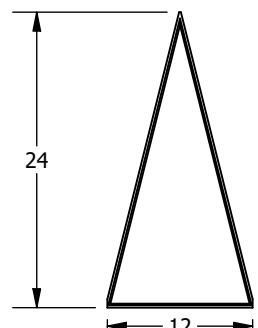

Ultima 9/16\"/>

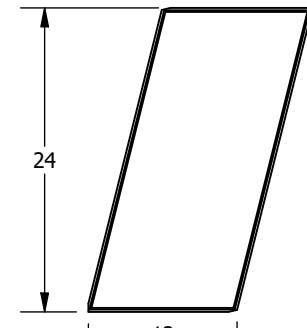

Ultima 9/16\"/>

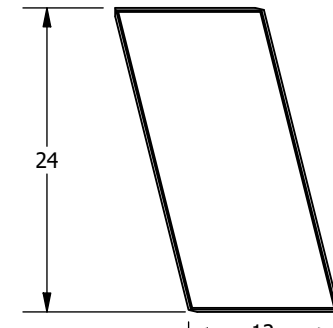

Ultima 9/16\"/>

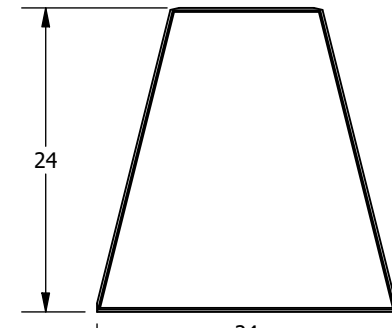

Ultima 9/16\"/>

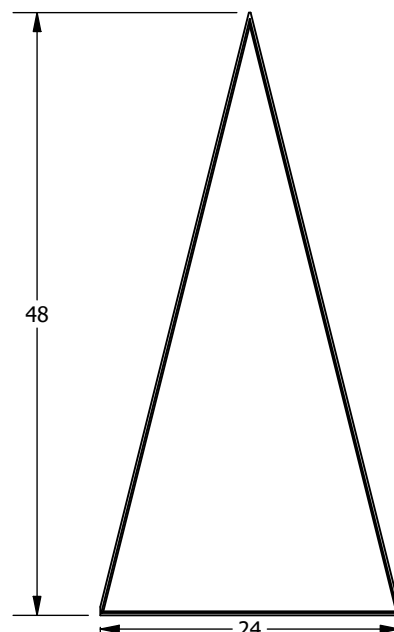

Ultima 9/16\"/>

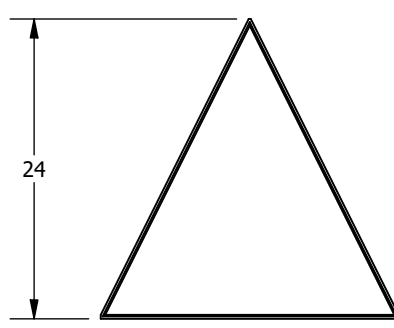

Ultima 9/16\"/>

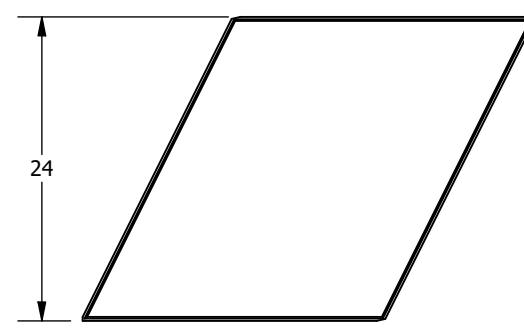

Ultima 9/16\"/>

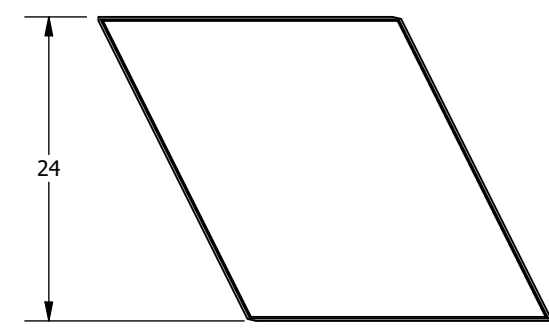

Ultima 9/16\"/>

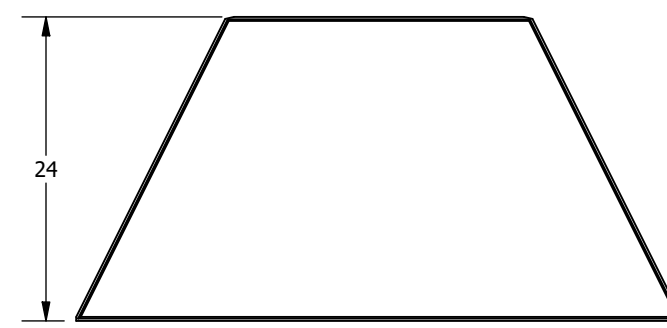

Ultima 9/16\"/>

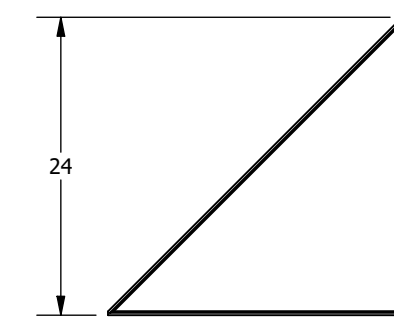

Ultima 9/16\"/>

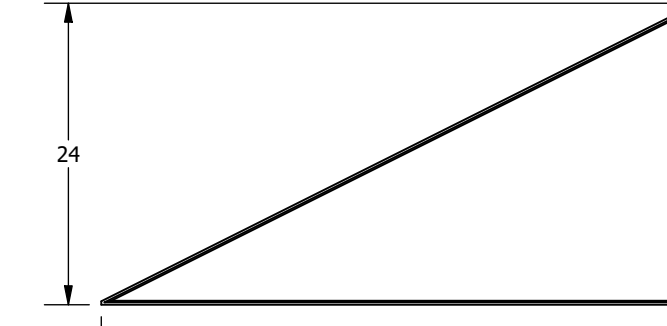

Ultima 9/16\"/>

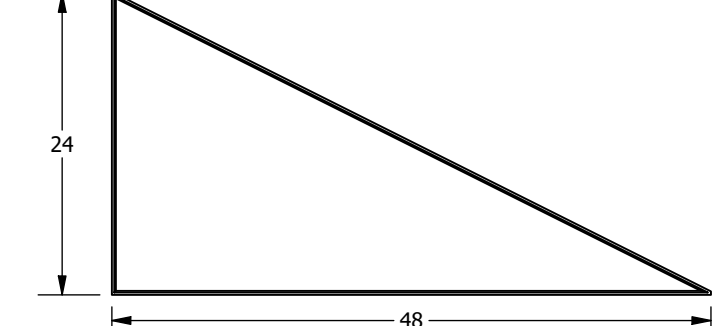

Ultima 9/16\"/>

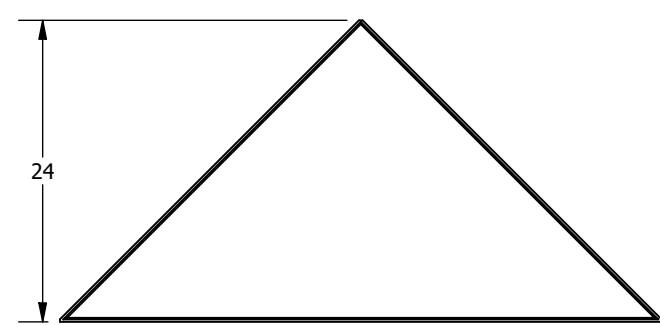

Ultima 9/16\"/>

- NOTES:
1. Views are from the face of the panel, and descriptions are based on these views
  2. Dimensions are nominal and reflect grid spacings
  3. Scale 1:15