

NOTES:
 THE EXAMPLE LAYOUT AND CORRESPONDING BOM SHOWN ARE MEANT TO BE USED AS REFERENCE POINTS WHEN SPECIFYING A DESIGNFLEX SYSTEM.
 IF YOU PLAN TO USE THE EXACT LAYOUT SHOWN, OR ANY VARIATION THEREOF, CONSIDER THE FOLLOWING NOTES:

- 1) DRAWING DETAILS SHOW A CEILING PLAN VIEW WHICH IS FROM A PLENUM POSITION LOOKING DOWN ONTO THE BACKSIDE OF THE CEILING SYSTEM. BOM LISTS DESCRIPTIONS THAT COORDINATE WITH THE DATA PAGES, AND THESE ITEM DESCRIPTIONS ARE BASED ON VIEWING THE FACE OF THE PRODUCTS.
- 2) ANGLE BRACKETS AND CORNER BRACKETS ARE INSTALLED AT STANDARD 6" OC ROUTE HOLE INCREMENTS ALONG THE MAIN BEAMS - ALL MAIN BEAMS ARE INSTALLED WITH ALIGNED ROUTE HOLES.
- 3) ANGLE BRACKETS USED WITHIN LAYOUTS HAVE SCREWS, WASHERS, AND NUTS INCLUDED WITH THEM FOR FASTENING TO MAIN BEAMS. IF CORNER BRACKETS ARE USED IN THE SYSTEM THEY WILL REQUIRE SCREWS THAT ARE NOT INCLUDED AND NEED TO BE SUPPLIED BY OTHERS.
- 4) SCREWS, RIVETS, AND OTHER GENERAL FASTENERS THAT ARE NOT INCLUDED IN BOM OR IN DETAILS BELOW, NEED TO BE SUPPLIED BY OTHERS. REFER TO INSTALLATION INSTRUCTIONS FOR DETAILS ON REQUIRED FASTENERS.
- 5) HANGER WIRE LOCATIONS SHOWN BELOW ARE ONLY SUGGESTIONS BASED ON EXAMPLE LAYOUT AND CAN BE MOVED IN ACCORDANCE WITH FOLLOWING REQUIREMENT - HANGER WIRES ARE REQUIRED ALONG MAINS WITHIN 24" OF THE WALL AND NO MORE THAN 48" O.C THEREAFTER.
- 6) CONDITIONS SHOWN ARE FOR NON-SEISMIC INSTALLATIONS (SEISMIC DESIGN CATEGORY A,B) - REFERENCE INSTALLATION INSTRUCTIONS FOR CONSIDERATIONS AND REQUIREMENTS FOR SEISMIC INSTALLATIONS.
- 7) DETAILS BELOW AND BOM ARE SUBJECT TO CHANGES AT THE PERIMETER BASED ON THE LAYOUT (LINEAR FEET OF PERIMETER, FULL SIZE VS. CUT PANELS, BORDER PANEL INSTALLATION METHOD).
- 8) 7800 WALL ANGLE PERIMETER SHOWN BELOW. REFERENCE INSTALLATION INSTRUCTIONS FOR DETAILS ON ALTERNATIVE PERIMETER SOLUTIONS.
- 9) BOM DOES NOT ACCOUNT FOR THE USE OF SCRAP OR EXCESS MATERIAL CUT FROM OTHER ITEMS.
- 10) REFER TO MASTER PARTS SHEET, PANEL SHEET, AND INSTALLATION INSTRUCTIONS ILLUSTRATIONS SHEET FOR SPECIFIC DETAIL VIEWS AND DIAGRAMS OF ALL PARTS AND PIECES LISTED IN BOM.

SH-0025-1 BILL OF MATERIALS				
ITEM	QTY	STOCK NUMBER	DESCRIPTION	
1	16	7800	Angle Molding	
2	76	7500/7501	12" ID/HD Suprafine Main Beam	
3	380	XL7520	2' Suprafine Cross Tee	
4	722	75CB45	Suprafine 45 Deg. Corner Bracket	
5	362	XM754524	Suprafine 45 Deg. Cross Tee - 24in MBS	
6	38	XM7524	Suprafine Perimeter Cross Tee - 24in MBS	
7	82	BERC2	2" Beam End Retaining Clip	
8	34	XTAC	Cross Tee Adapter Clip	
9	72	PAC	Perimeter Angle Clip	
10	800	100008	Lyra 9/16" Square Tegular - 45 Deg. 24 in Base Rt. Triangle	
11	209	7891	12 Gauge Hanger Wire (Qty. = number of min. hanging point locations)	

EXAMPLE LAYOUT AND BOM SHOWN WITH LYRA PANELS AND SUPRAFINE SUSPENSION SYSTEM

PANEL PRODUCT FAMILIES COMPATIBLE WITH THIS LAYOUT:
 LYRA, OPTIMA, CALLA, ULTIMA, METALWORKS TEGULAR, AND WOODWORKS TEGULAR

SUSPENSION SYSTEMS COMPATIBLE WITH THIS LAYOUT:
 SUPRAFINE ID/HD

SIDE A - REPRESENTS A BORDER CONDITION UTILIZING A SINGLE GRID MEMBER CONNECTION TO THE PERIMETER

SIDE B - REPRESENTS A BORDER CONDITION UTILIZING A SINGLE GRID MEMBER CONNECTION OR MULTIPLE GRID MEMBER CONNECTIONS TO THE PERIMETER

REFERENCE INSTALLATION INSTRUCTIONS FOR FURTHER DETAILS ON HOW THESE BORDER CONDITIONS ARE INSTALLED

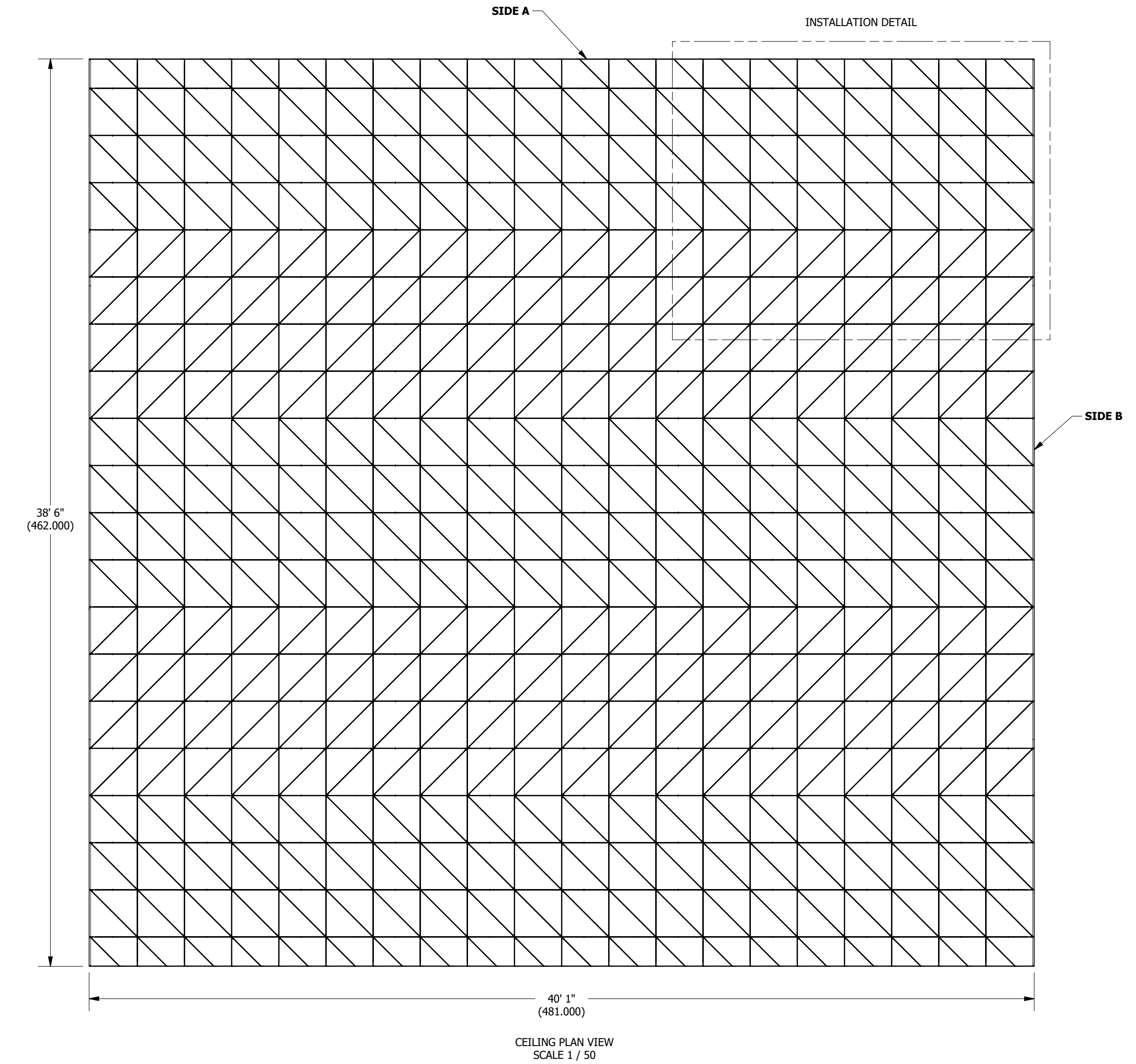
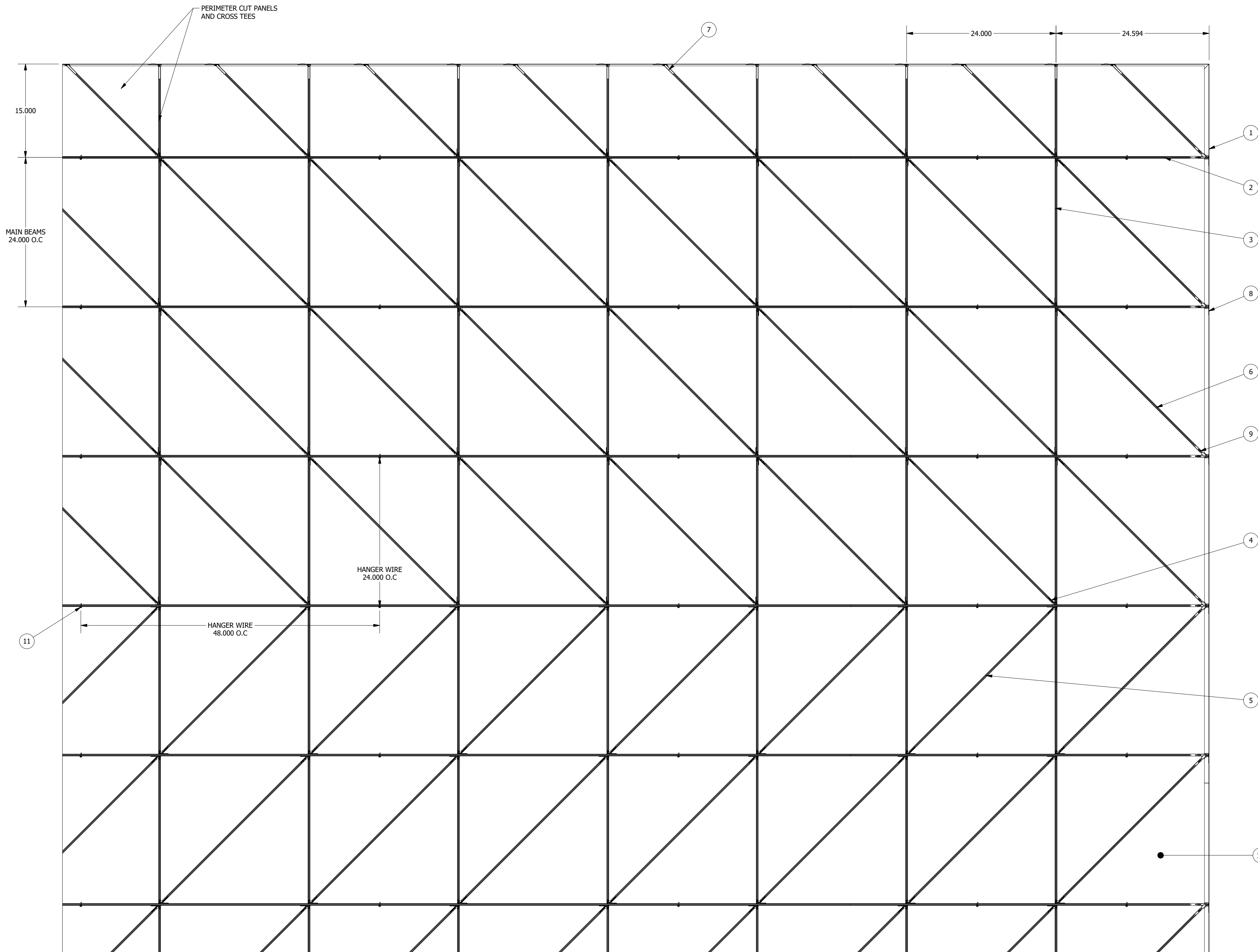

INSTALLATION DETAIL
 SCALE 1 / 10



DESIGNFLEX SH-0025-1 DRAWN BY: NJF DATE: 10/2/2018 PD

These drawings show typical conditions which the Armstrong products depicted are installed. They are not a substitute for an architect's or engineer's plan and do not reflect the unique requirements of local building codes, laws, statutes, ordinances, rules and regulations (Legal Requirements) that may be applicable for a particular installation. Armstrong does not warrant, and assumes no liability for the accuracy or completeness of the drawings for a particular installation or their fitness for a particular purpose. The user is advised to consult with a duly licensed architect or engineer in the particular locale of the installation to assure compliance with all legal requirements. Armstrong is not licensed to provide professional architecture or engineering design services.

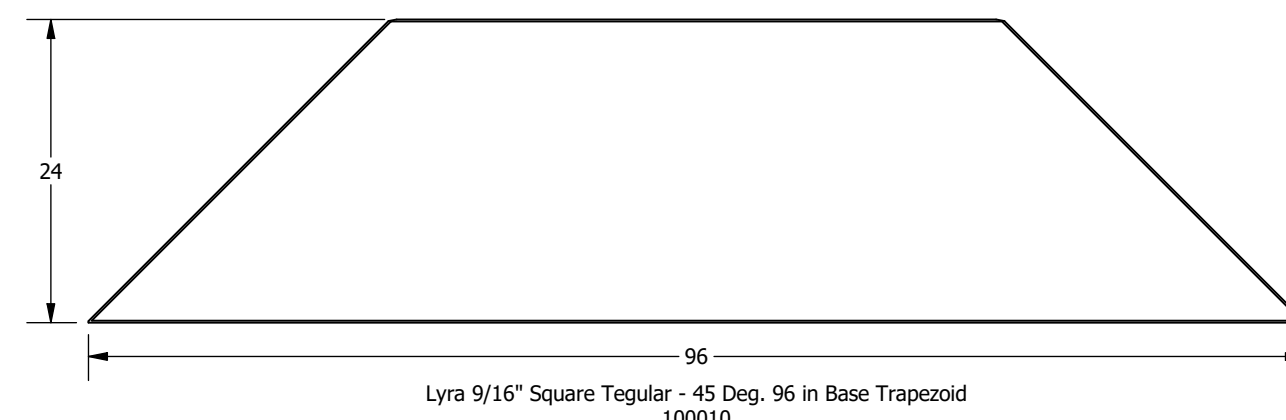
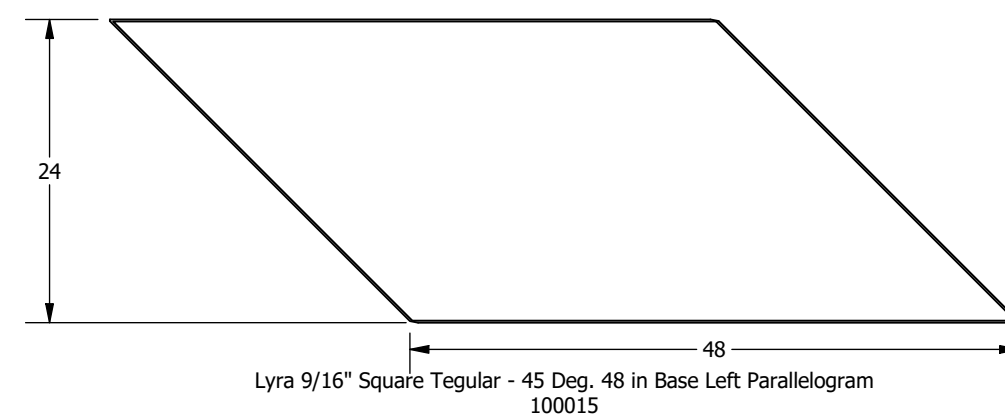
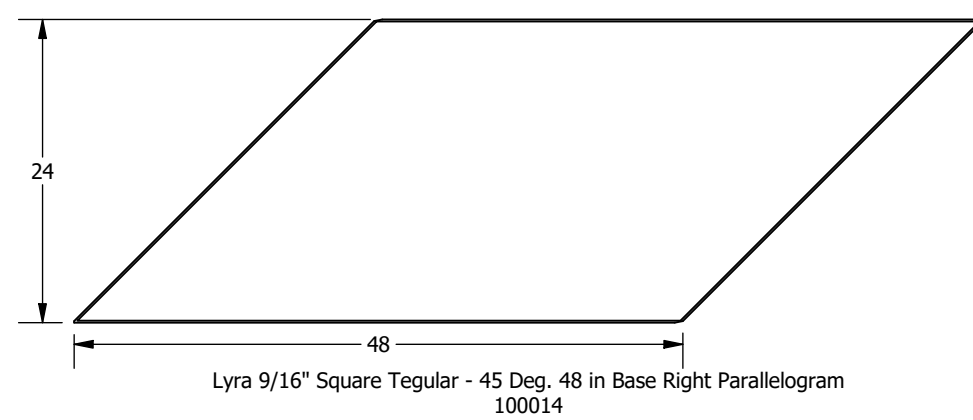
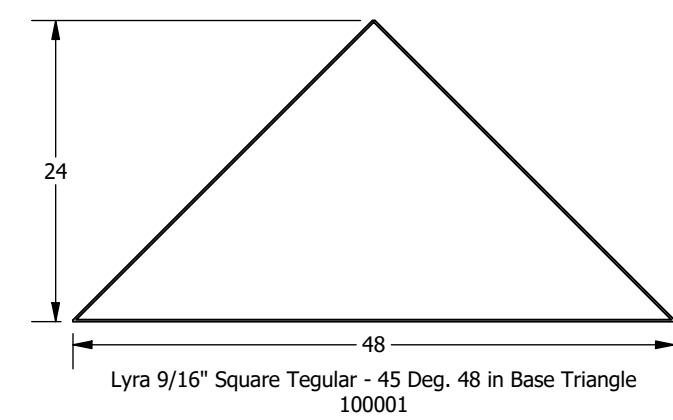
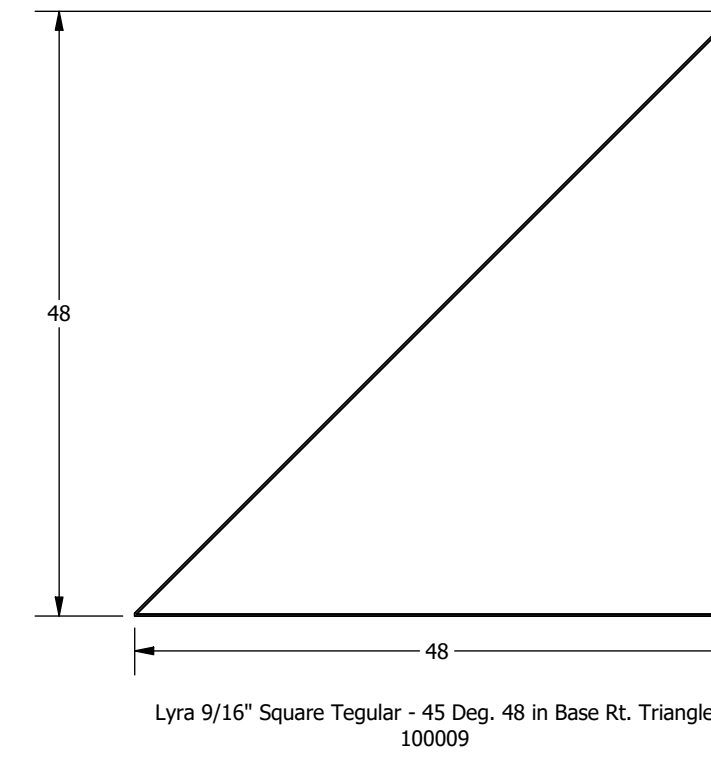
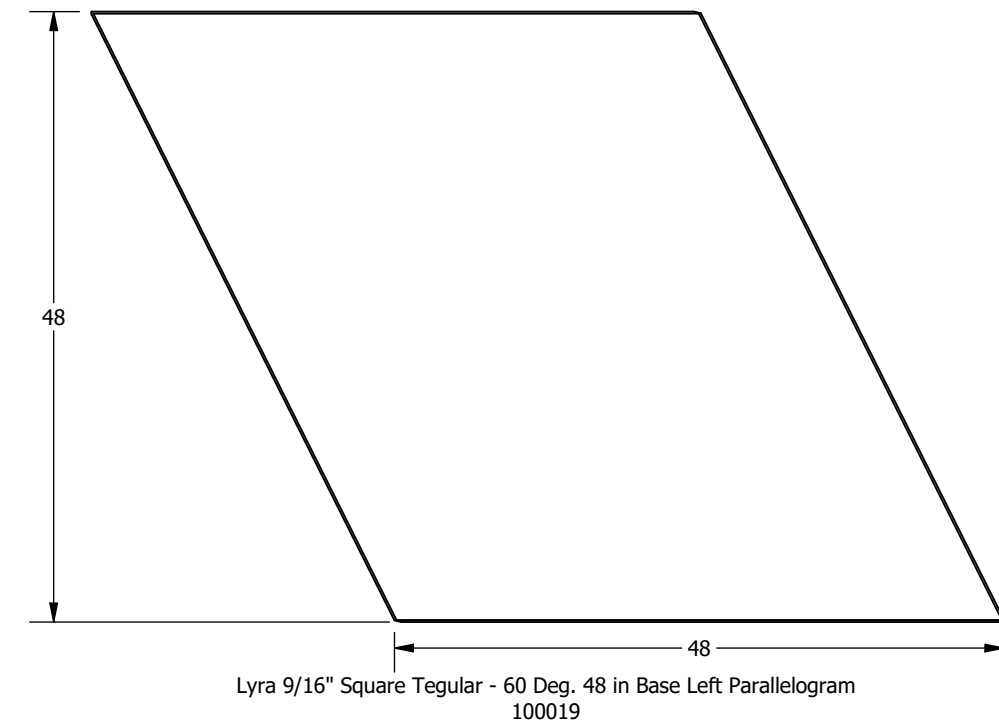
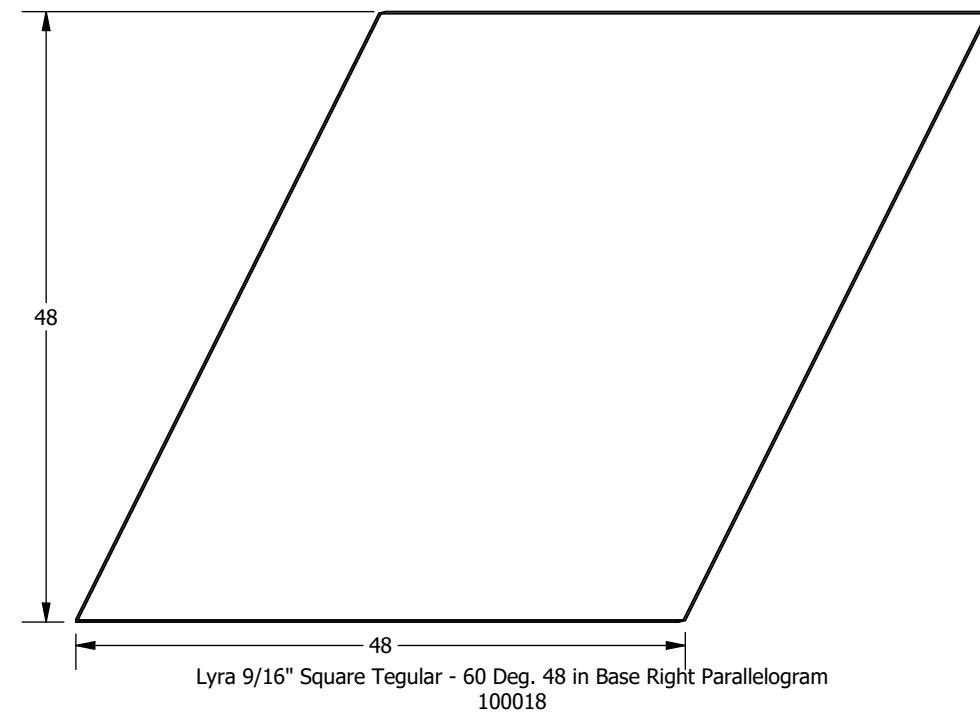
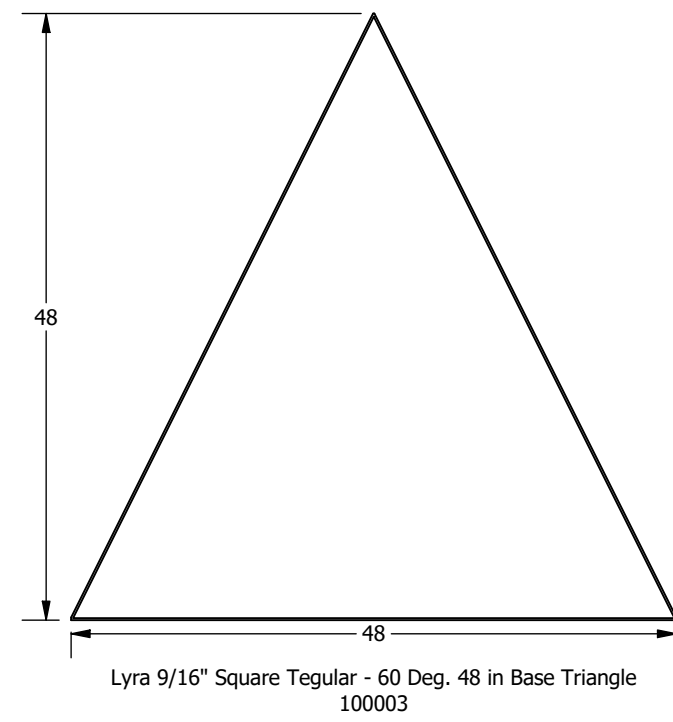
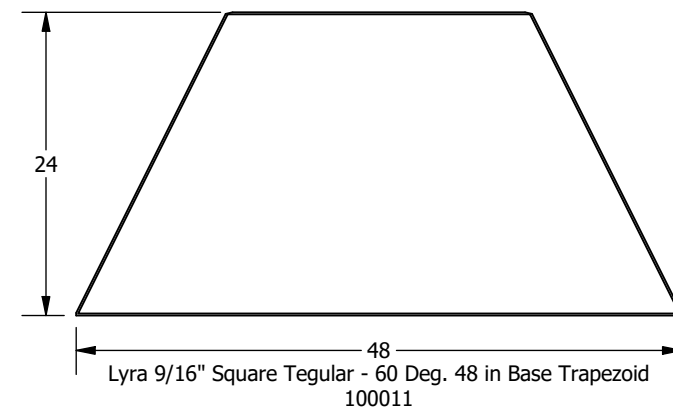
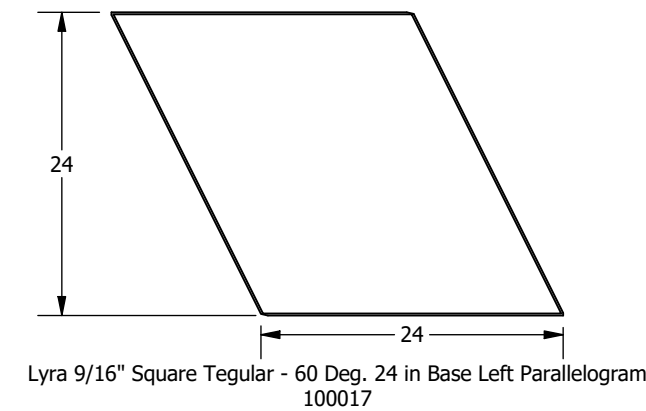
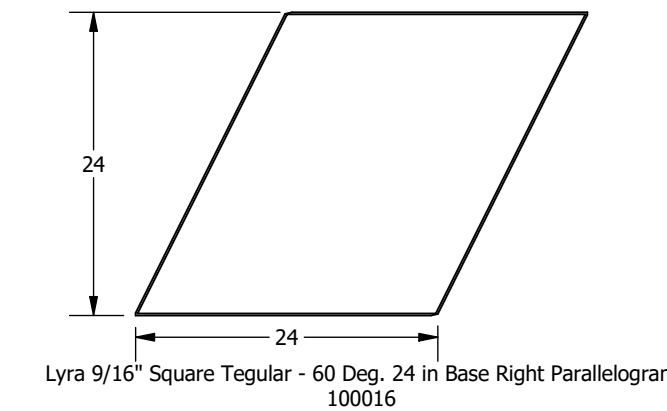
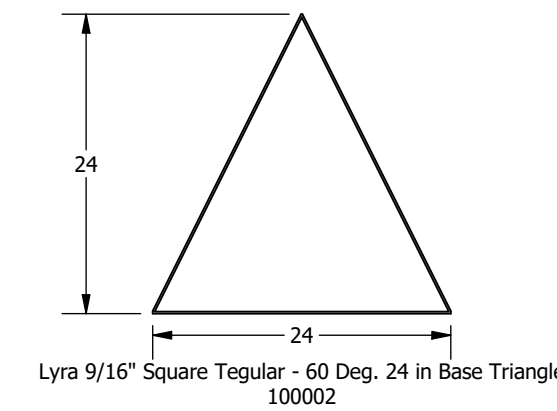
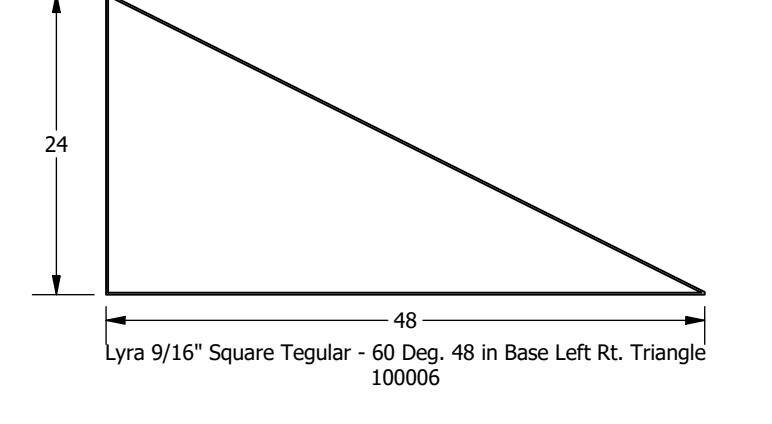
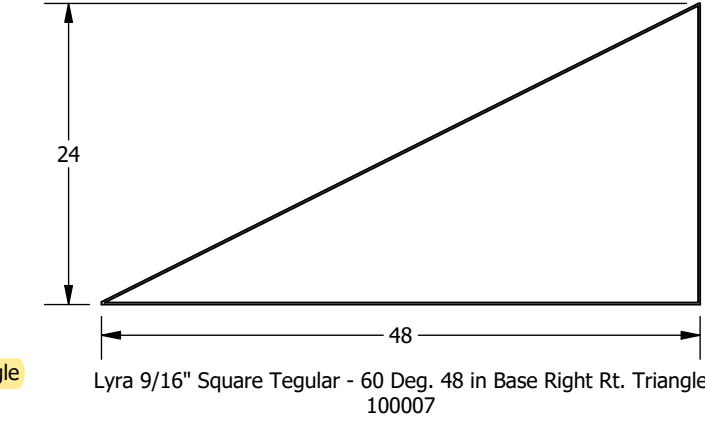
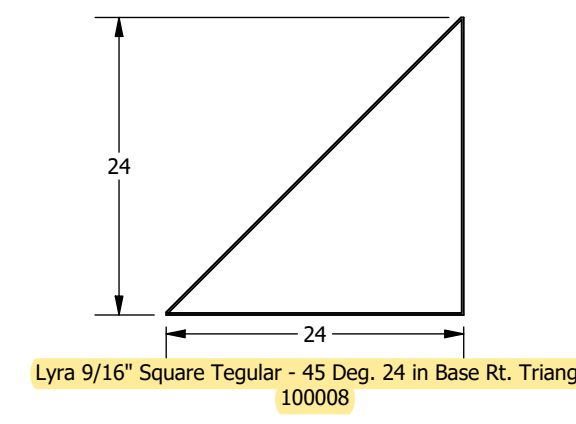
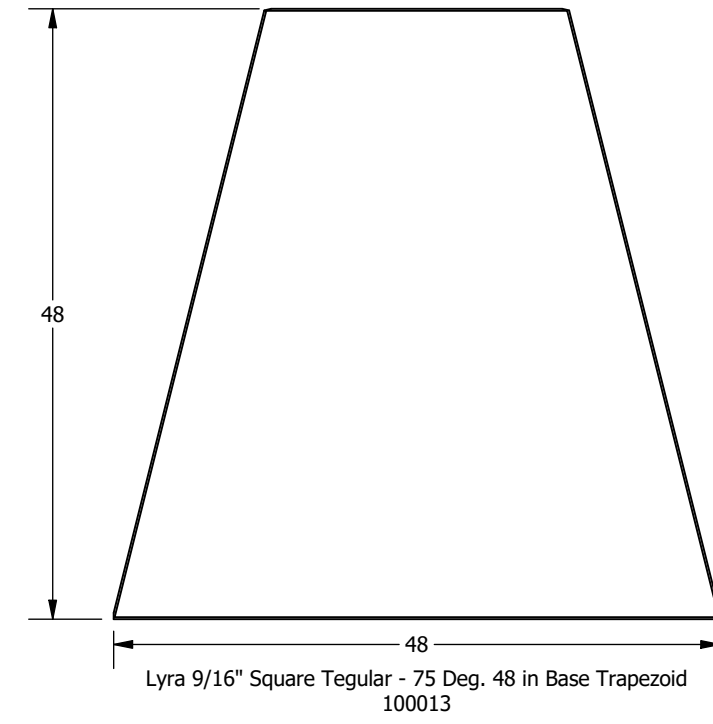
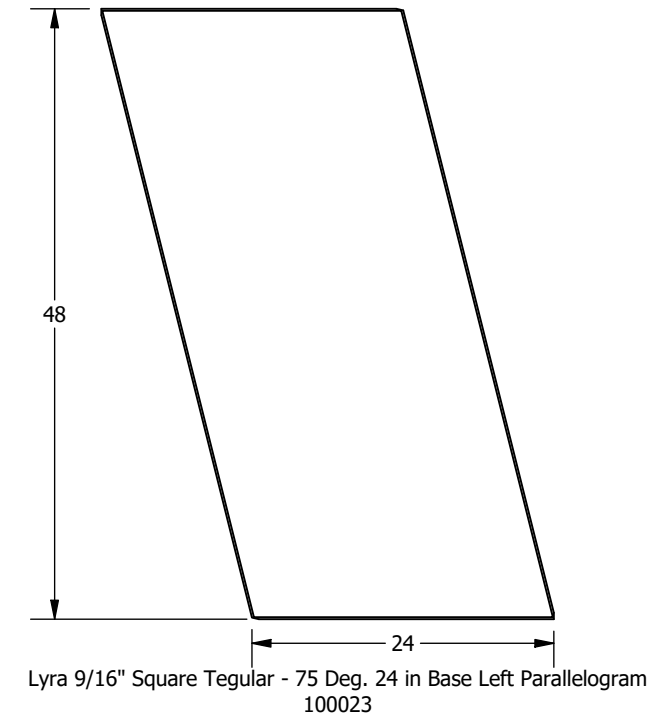
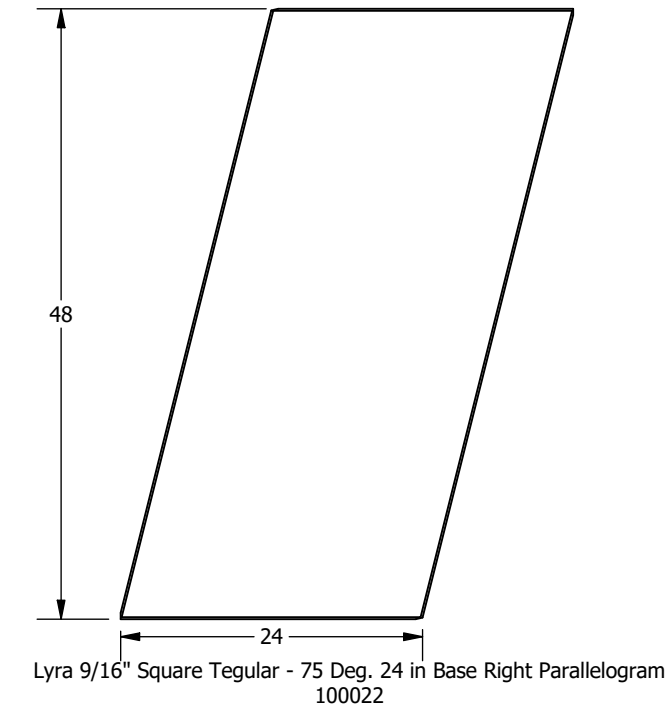
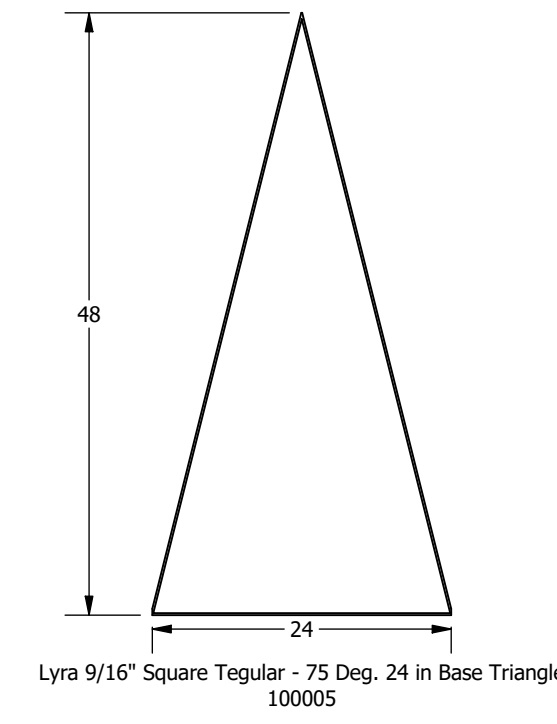
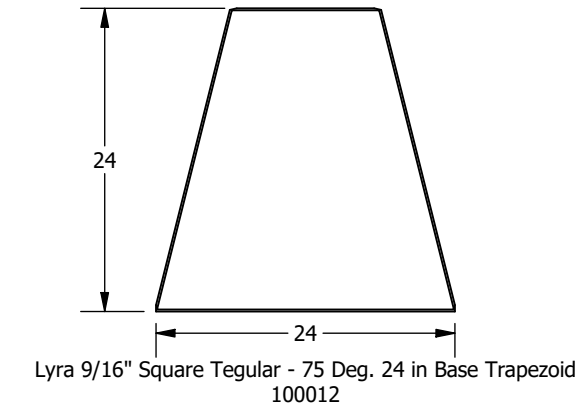
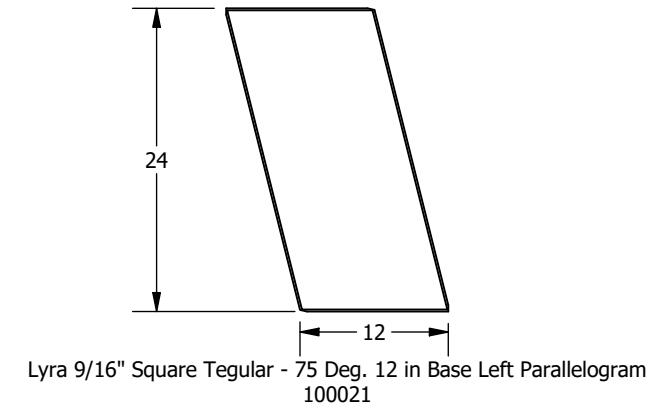
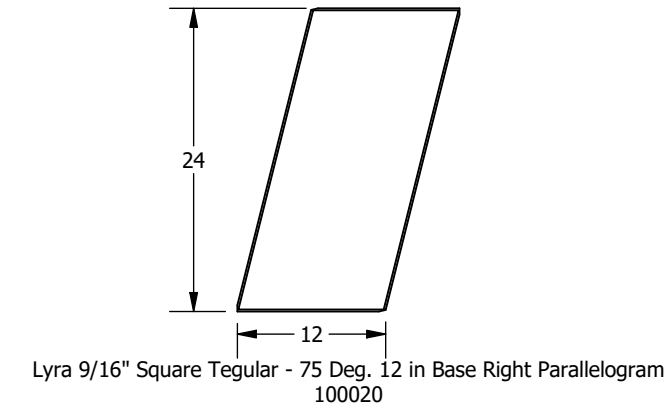
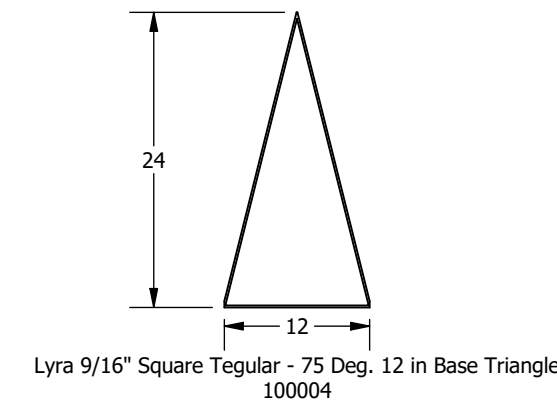

NOTES:
 1. Views are from the face of the panel, and descriptions are based on these views
 2. Dimensions are nominal and reflect grid spacings
 3. Scale 1:15

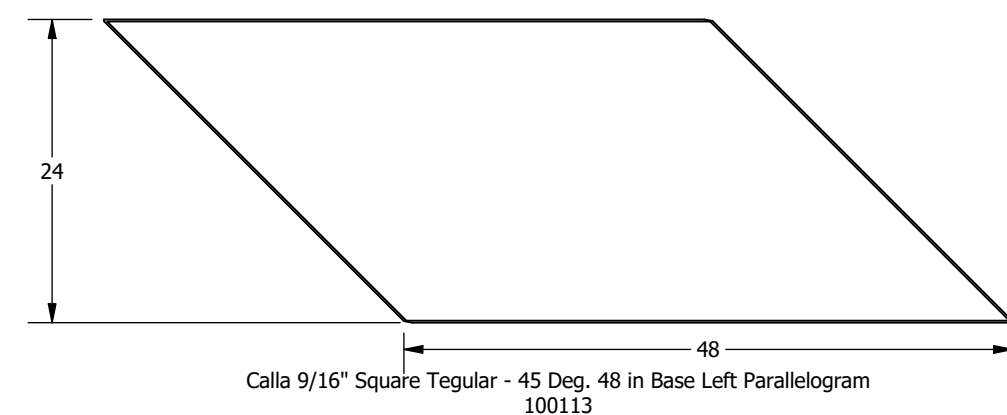
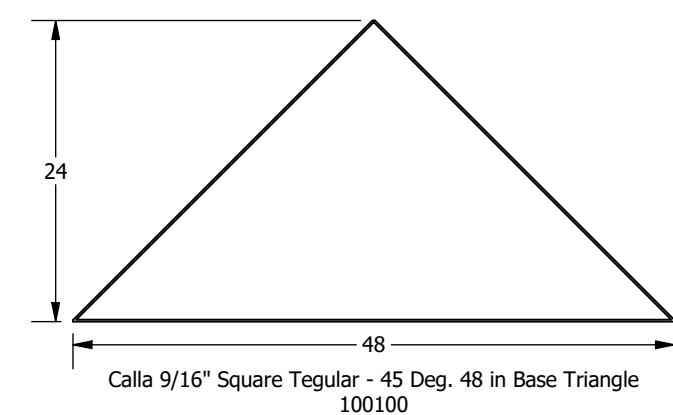
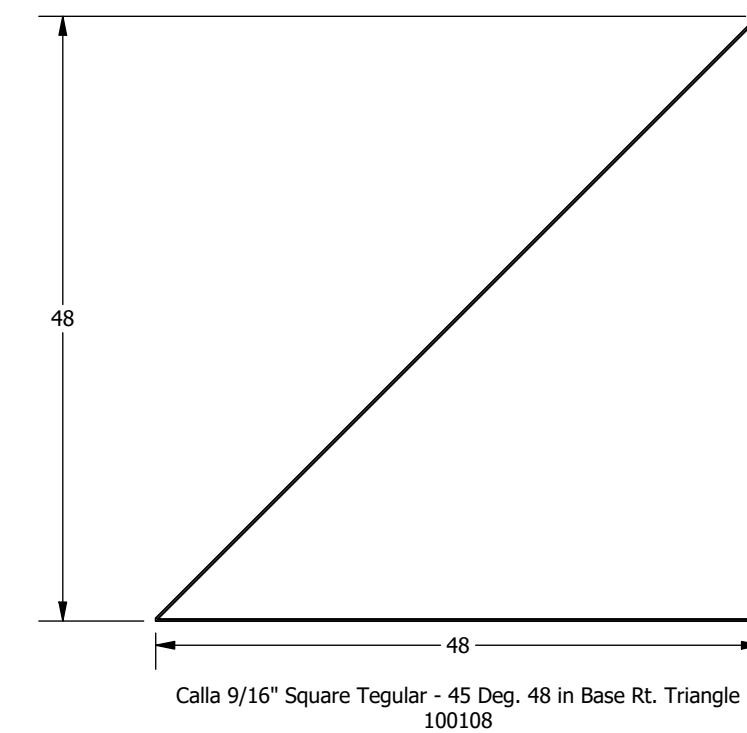
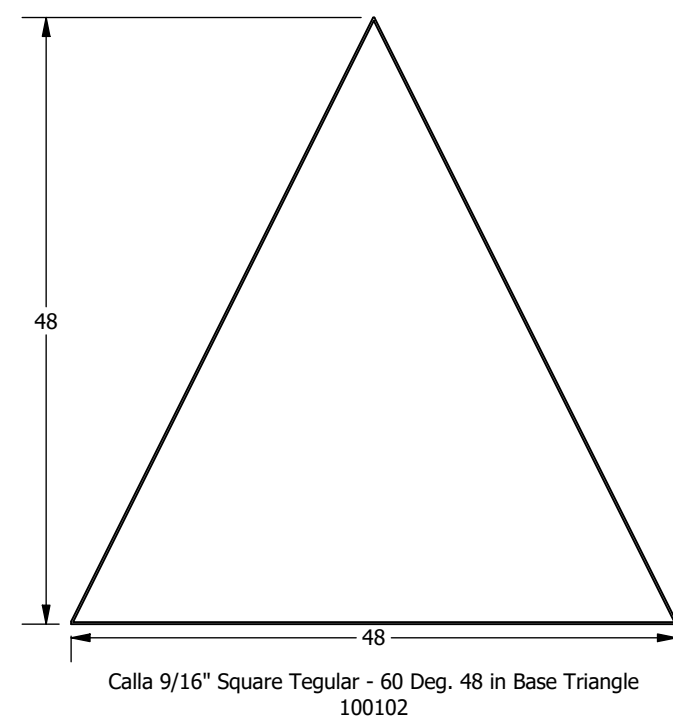
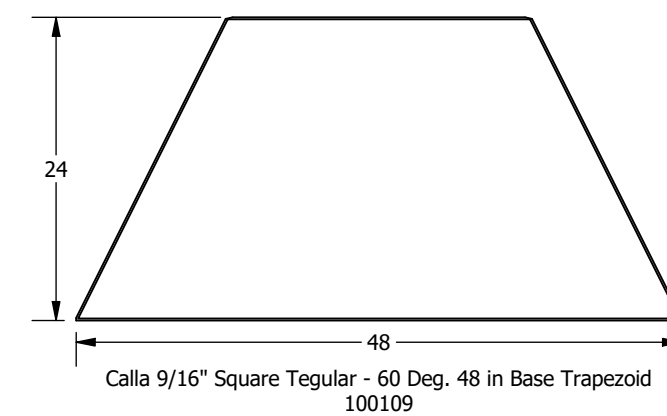
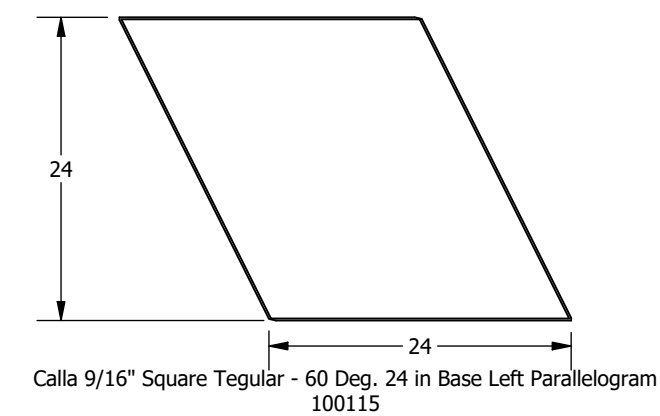
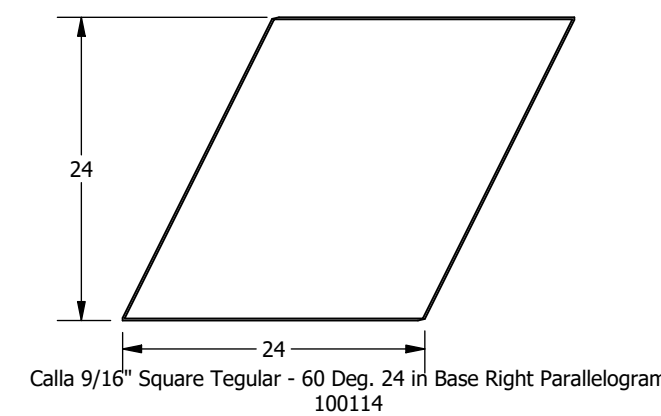
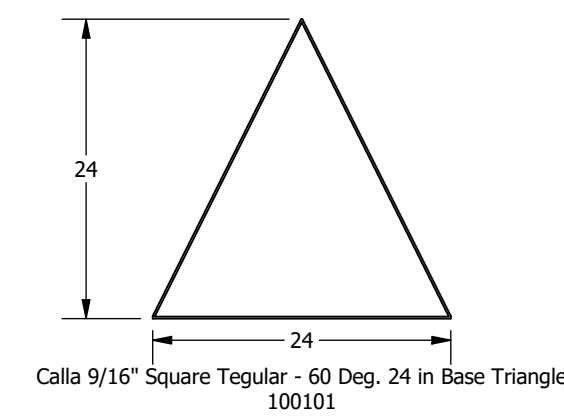
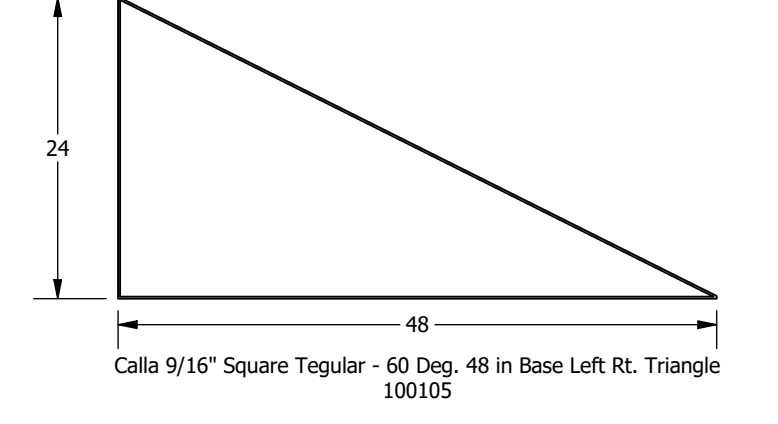
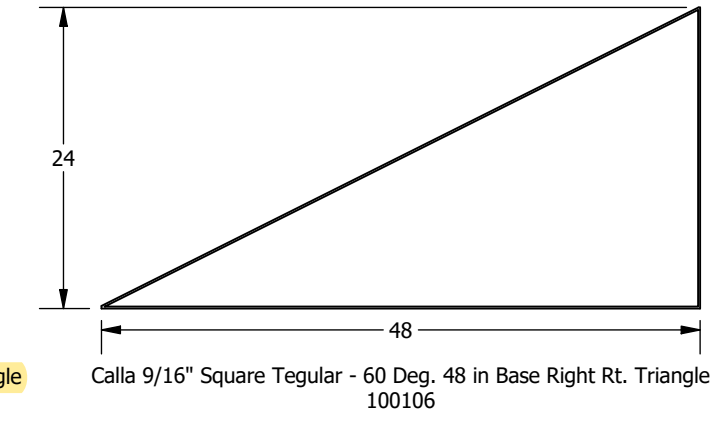
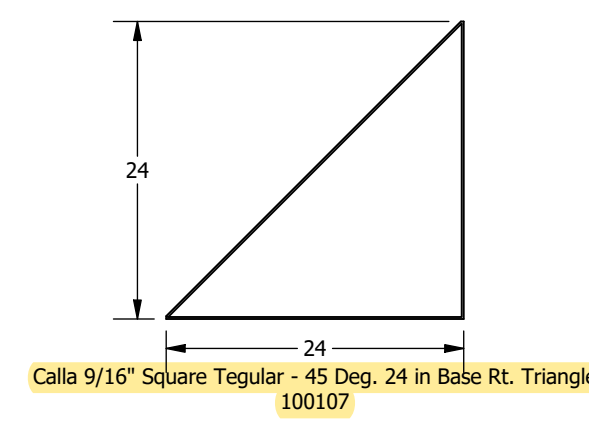
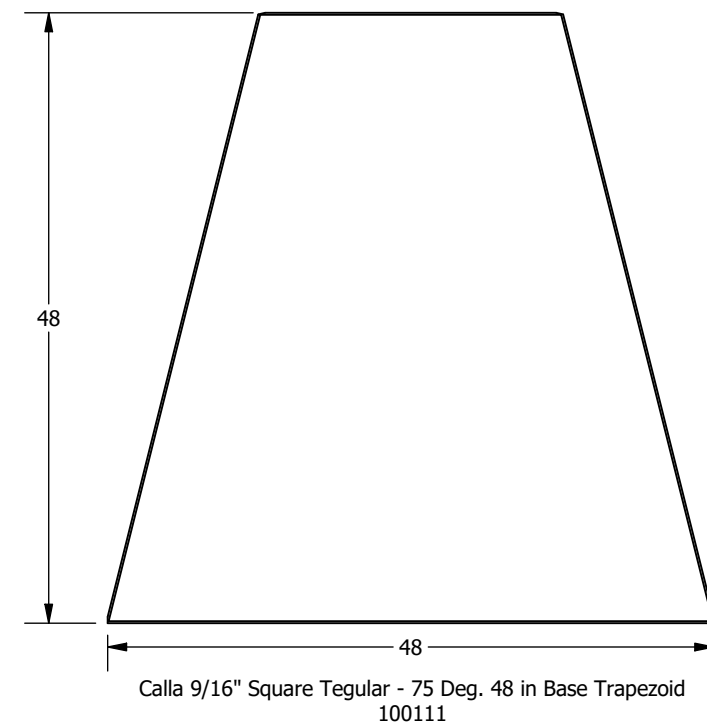
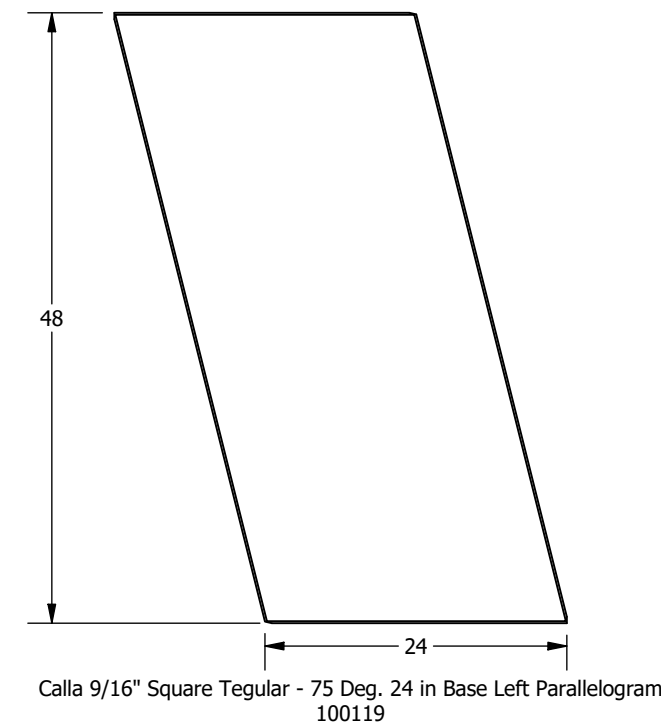
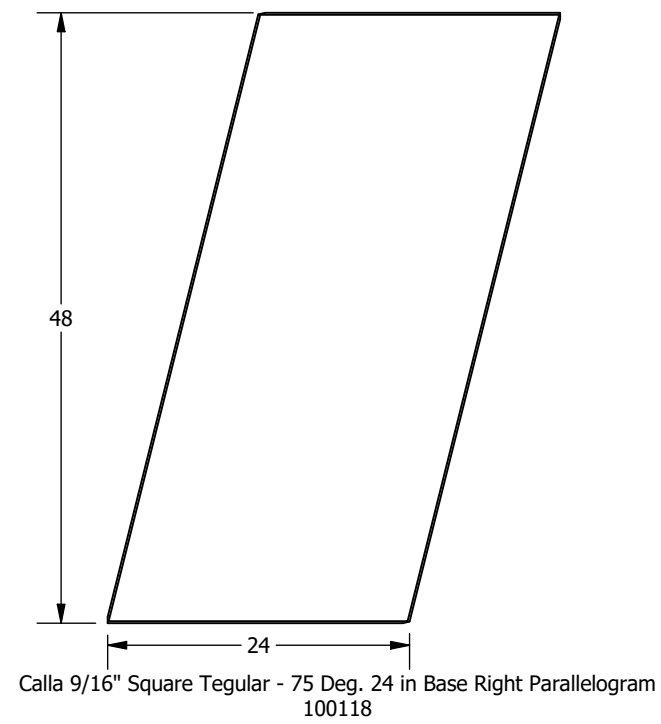
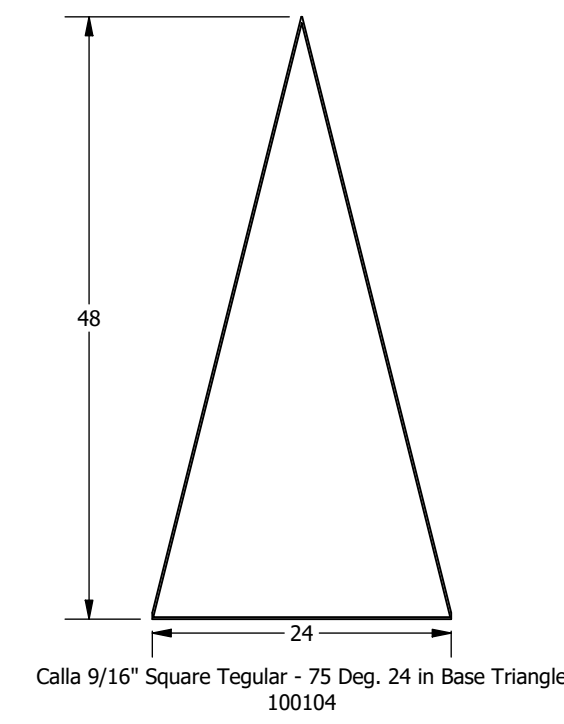
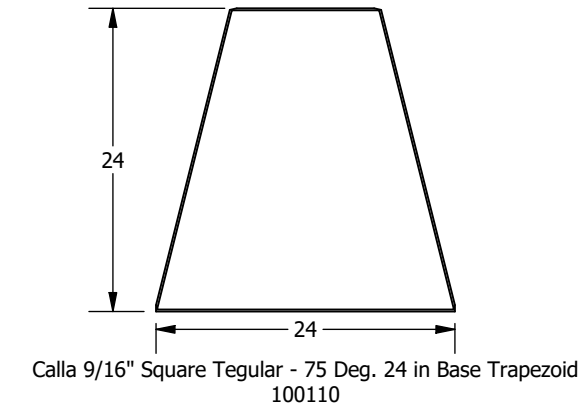
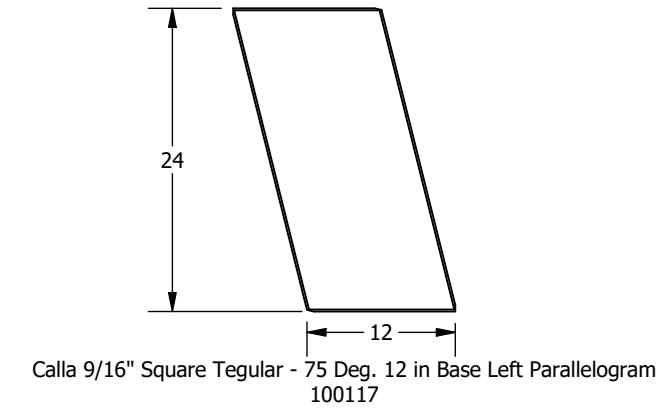
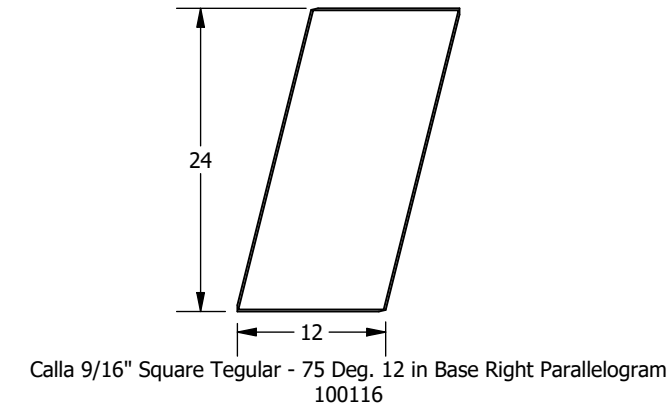
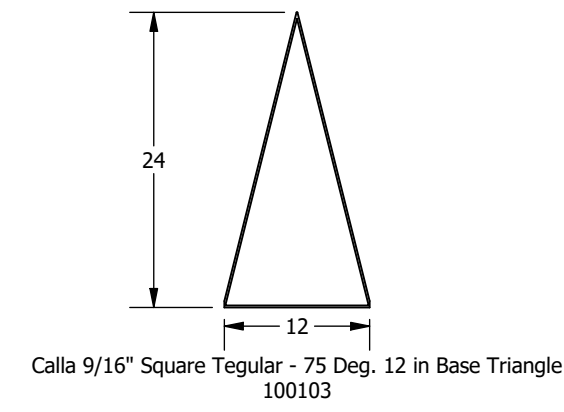

NOTES:
1. Views are from the face of the panel, and descriptions are based on these views
2. Dimensions are nominal and reflect grid spacings
3. Scale 1:15

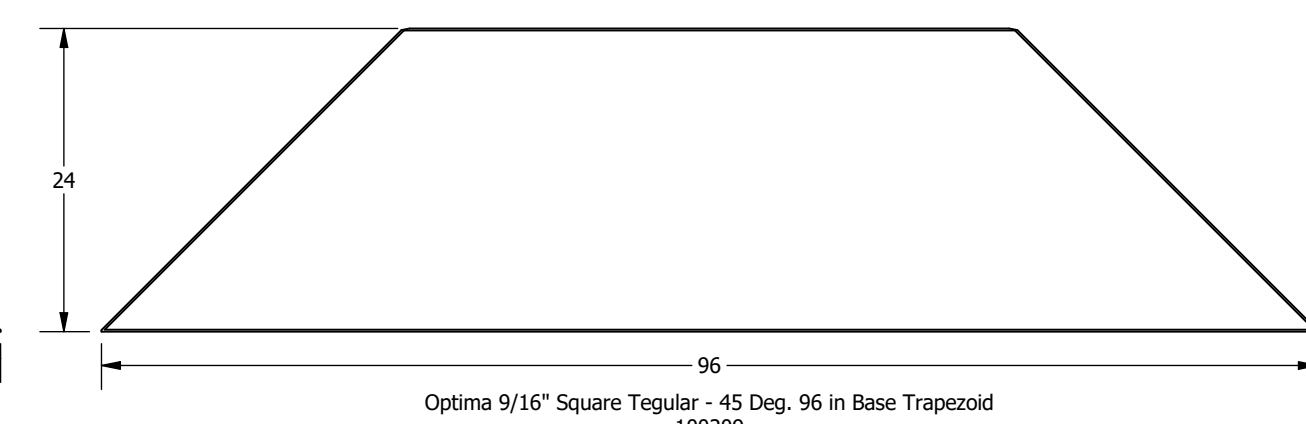
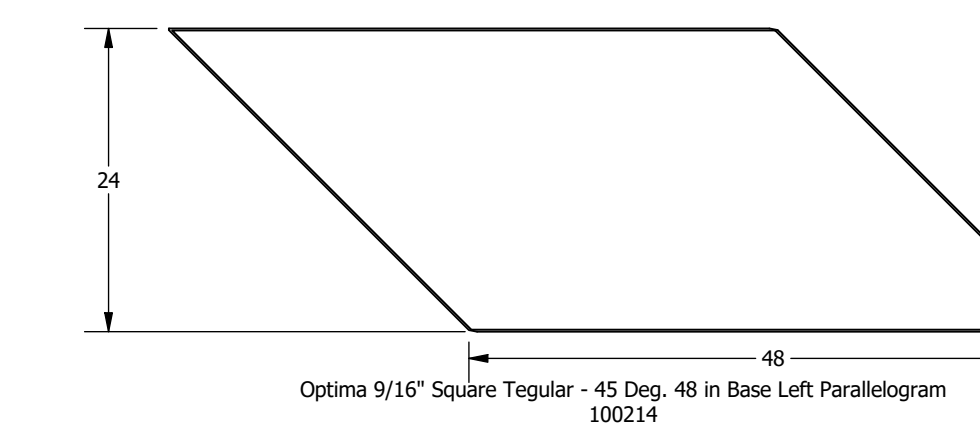
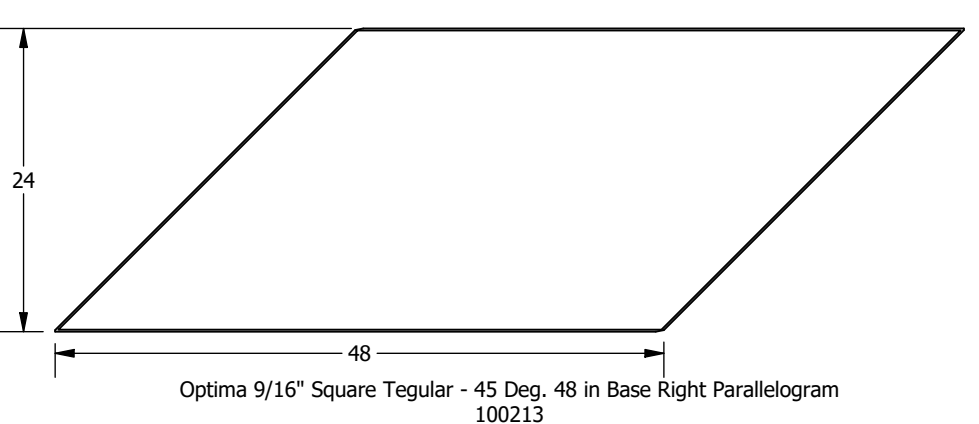
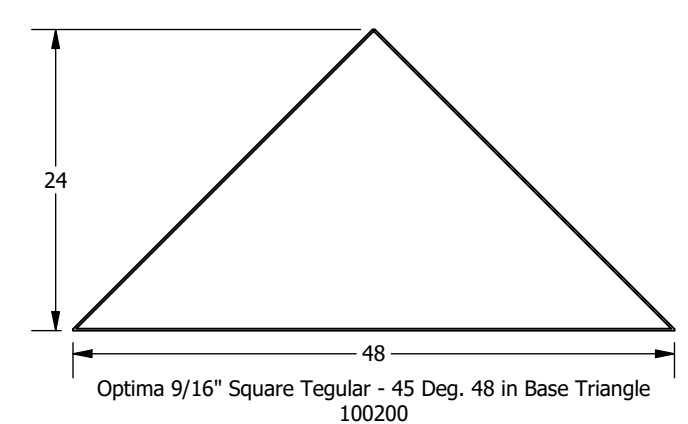
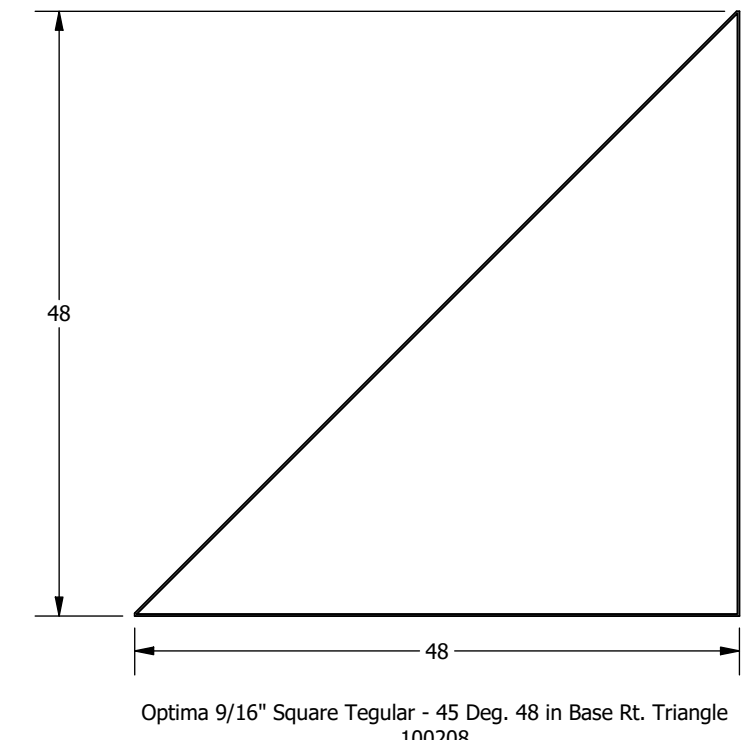
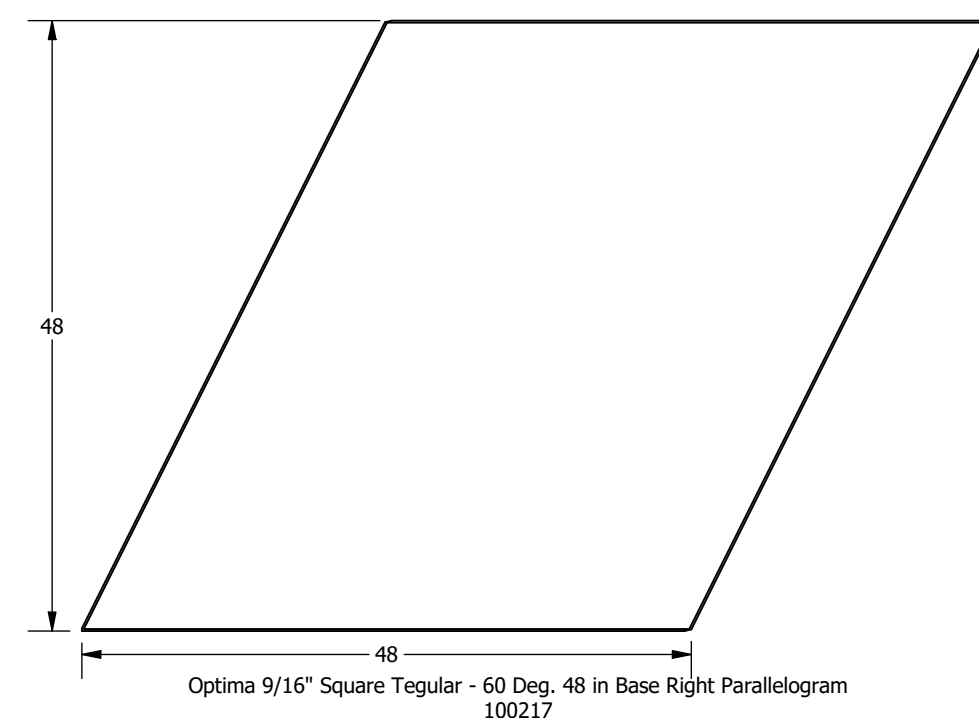
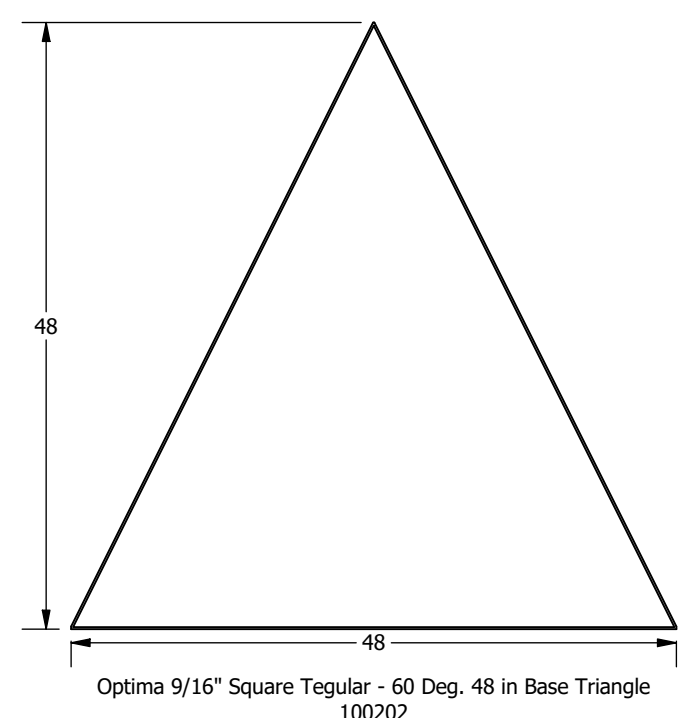
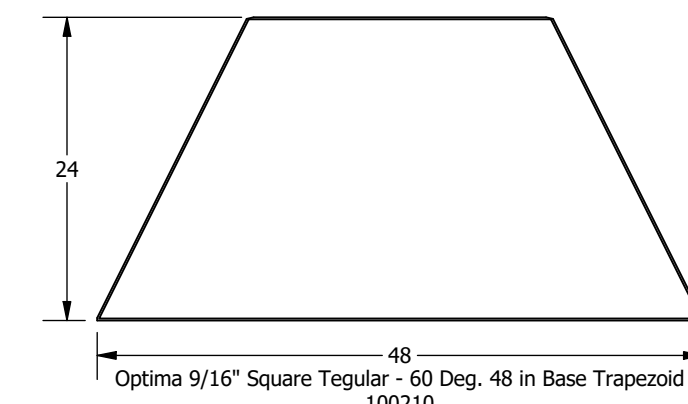
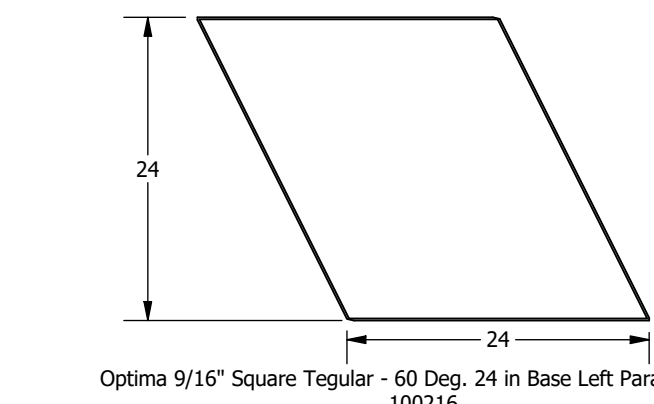
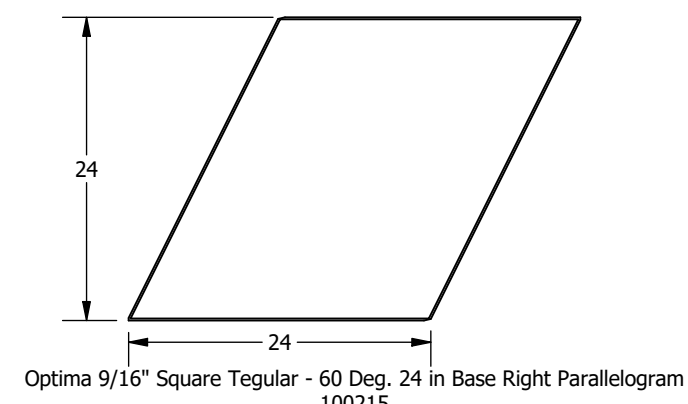
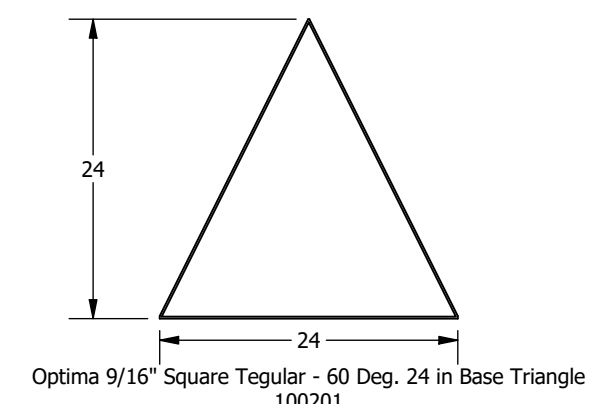
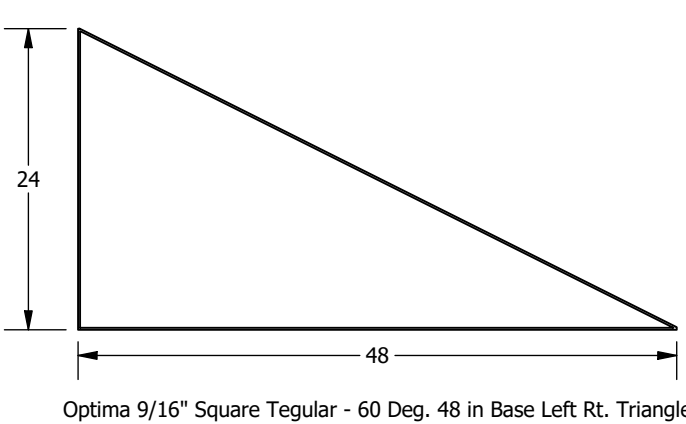
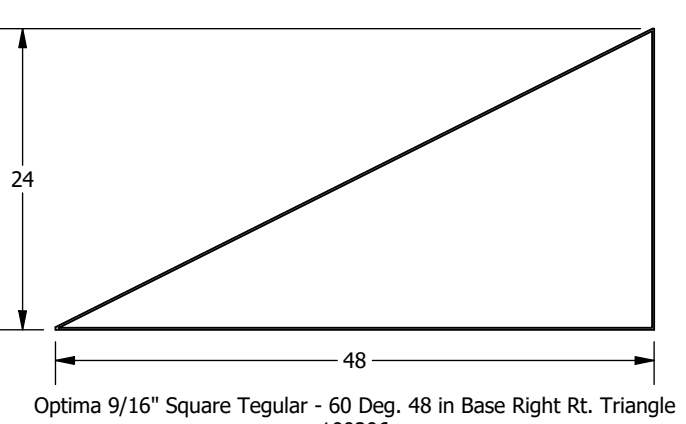
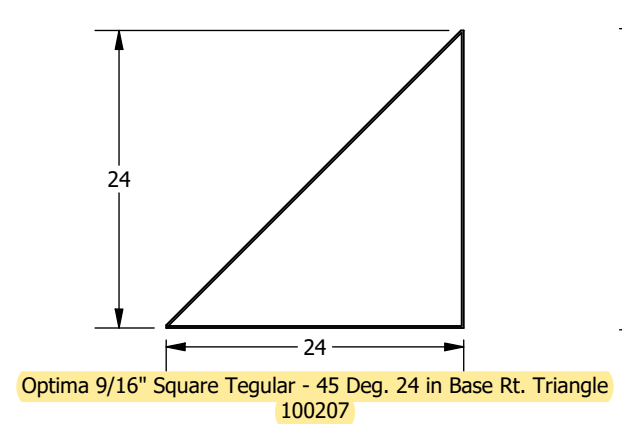
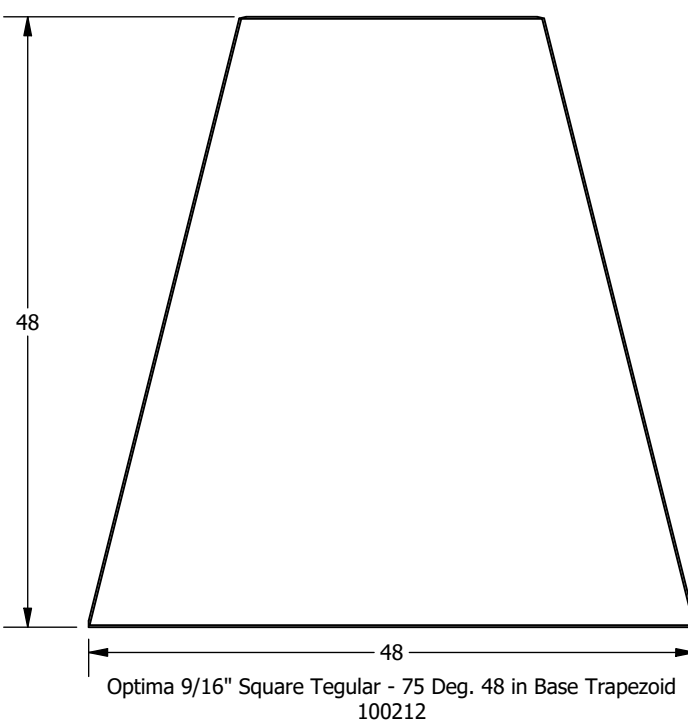
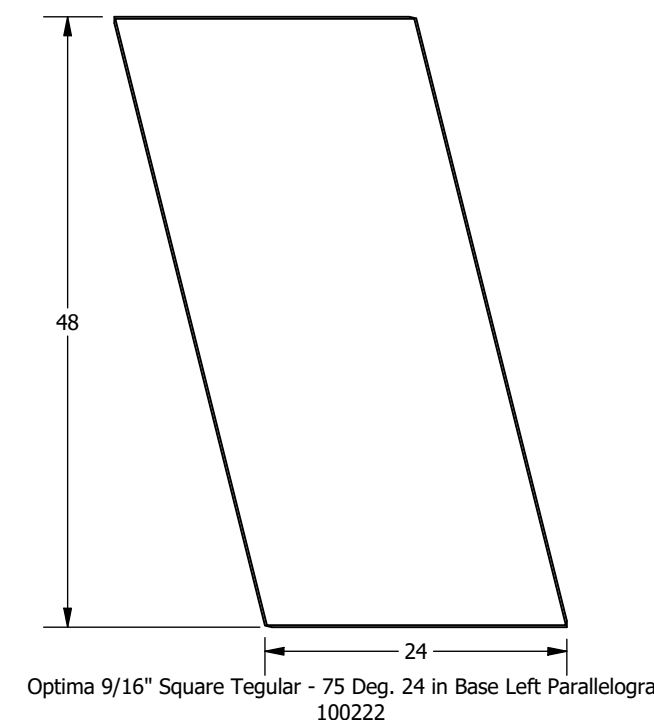
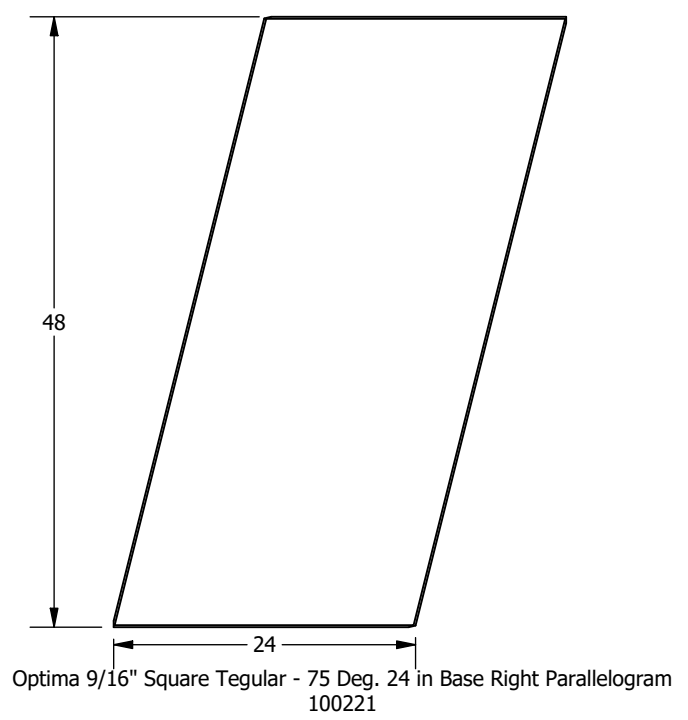
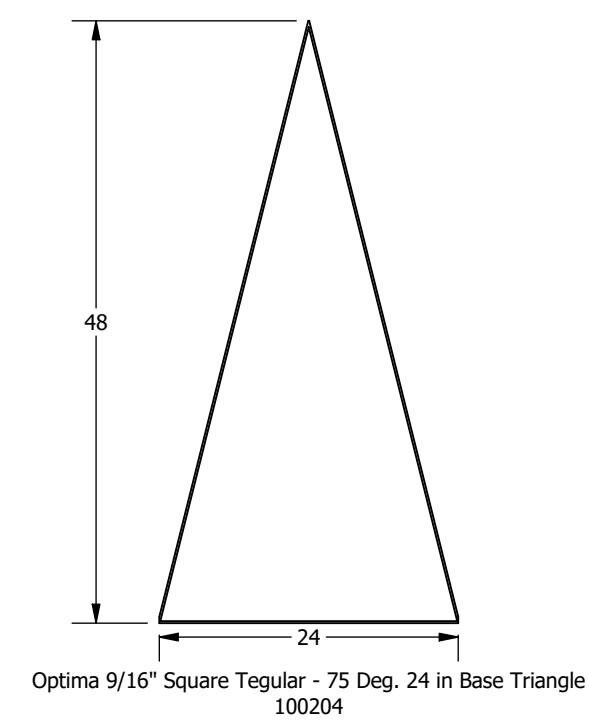
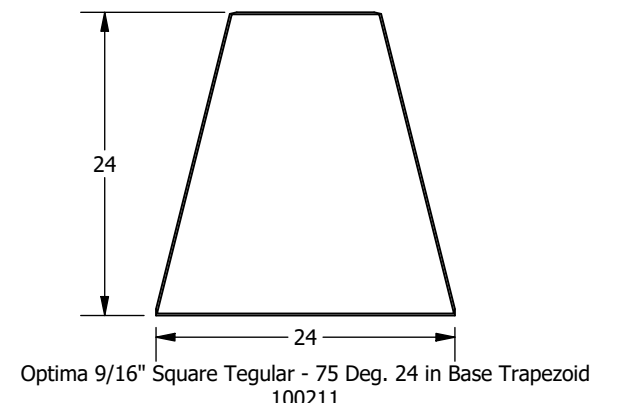
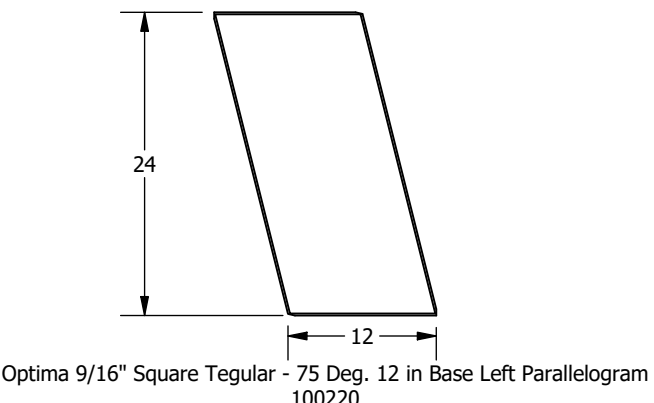
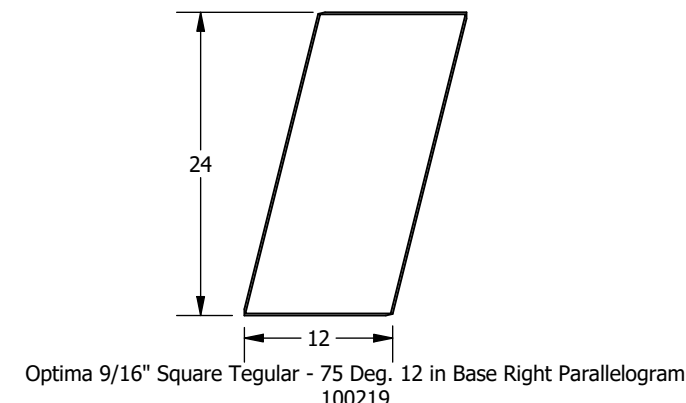
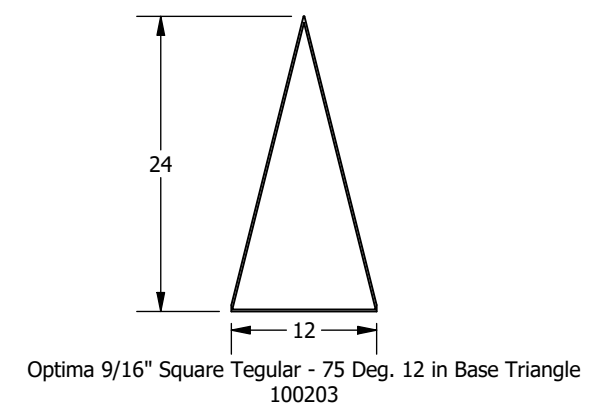

NOTES:
1. Views are from the face of the panel, and descriptions are based on these views
2. Dimensions are nominal and reflect grid spacings
3. Scale 1:15

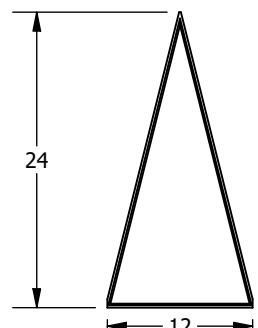

Ultima 9/16\"/>

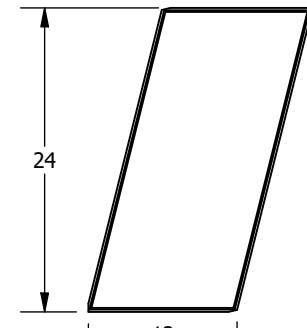

Ultima 9/16\"/>

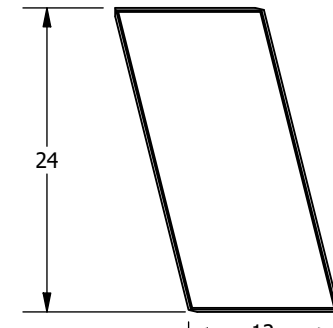

Ultima 9/16\"/>

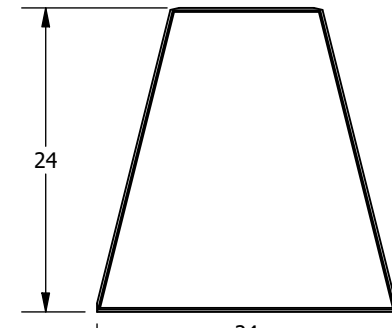

Ultima 9/16\"/>

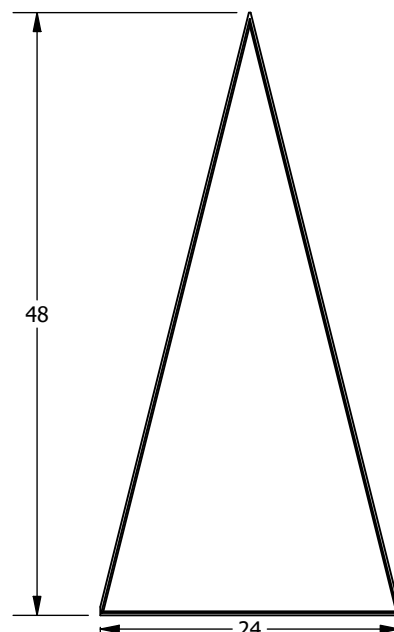

Ultima 9/16\"/>

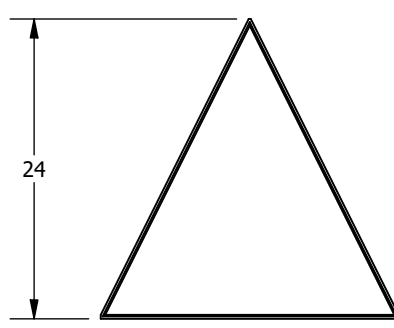

Ultima 9/16\"/>

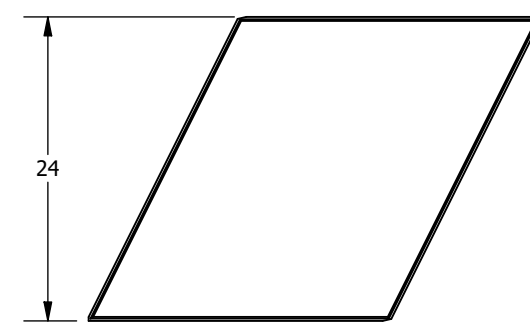

Ultima 9/16\"/>

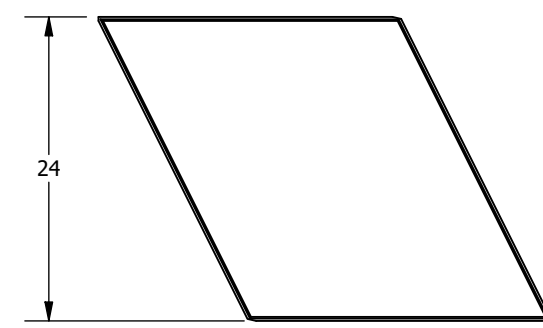

Ultima 9/16\"/>

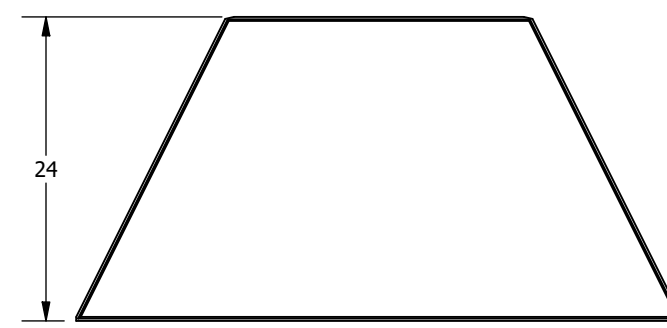

Ultima 9/16\"/>

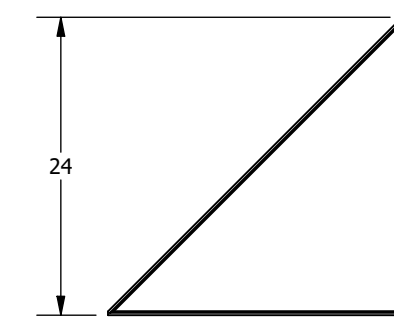

Ultima 9/16\"/>

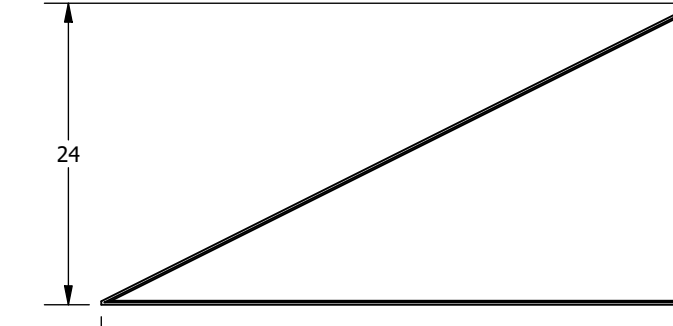

Ultima 9/16\"/>

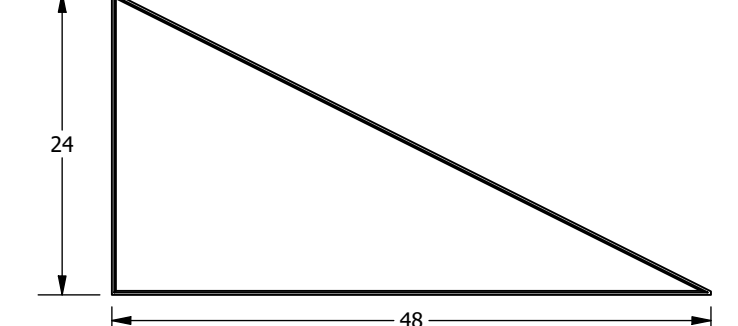

Ultima 9/16\"/>

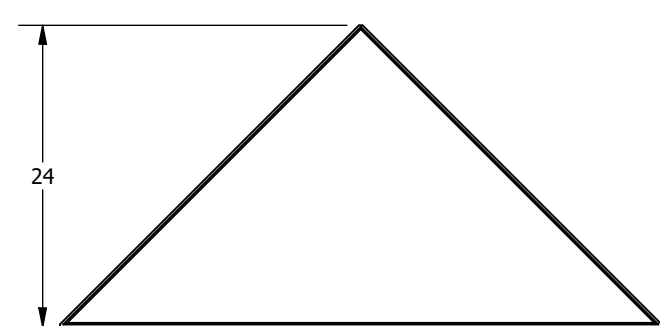

Ultima 9/16\"/>

- NOTES:
- Views are from the face of the panel, and descriptions are based on these views
 - Dimensions are nominal and reflect grid spacings
 - Scale 1:15

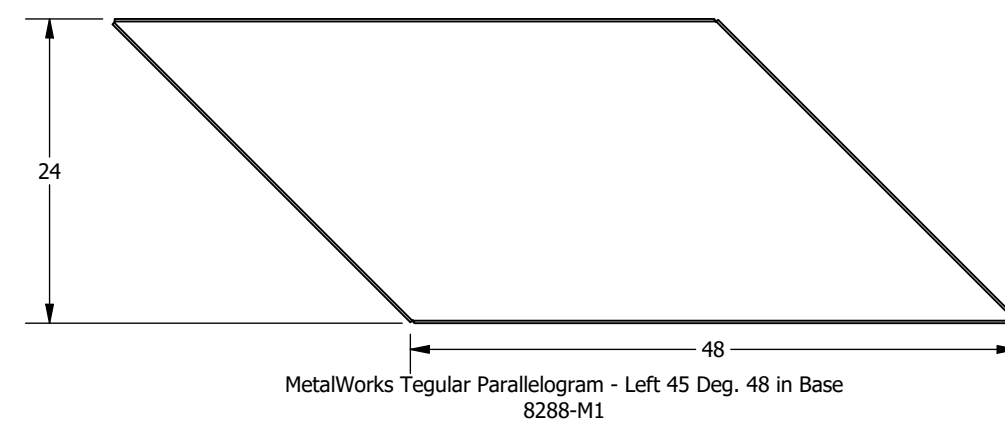
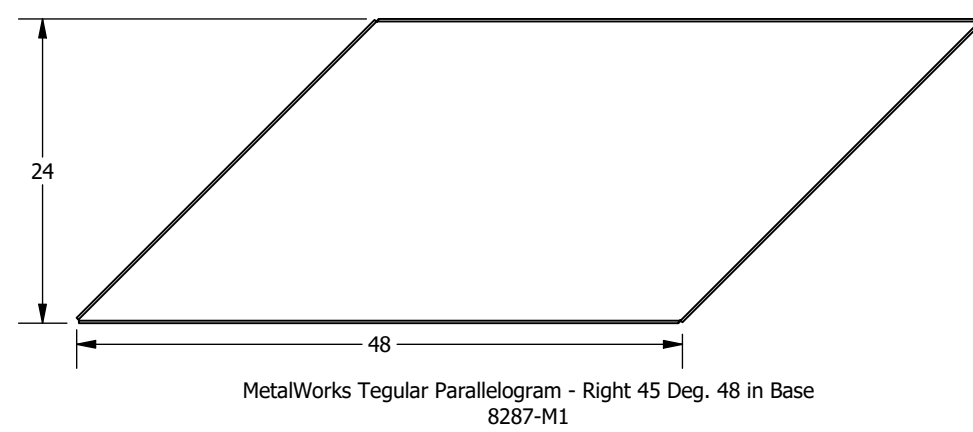
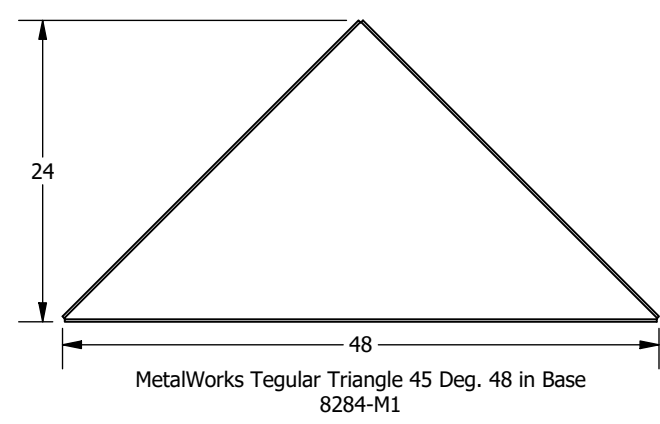
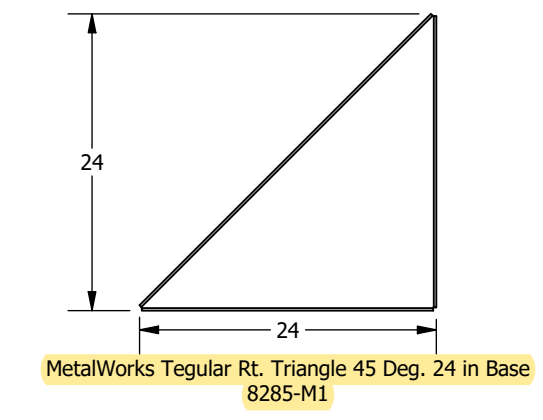
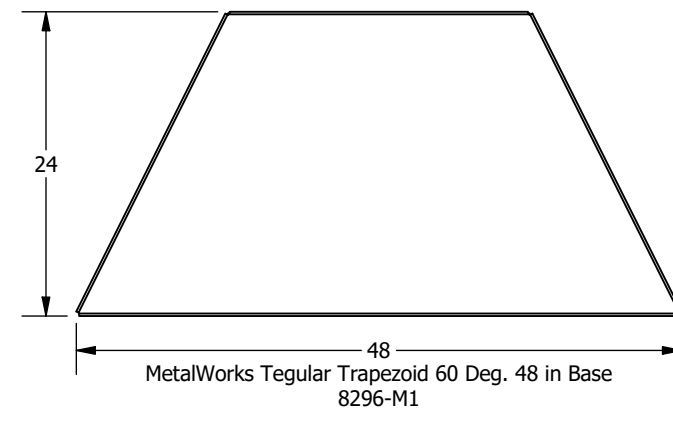
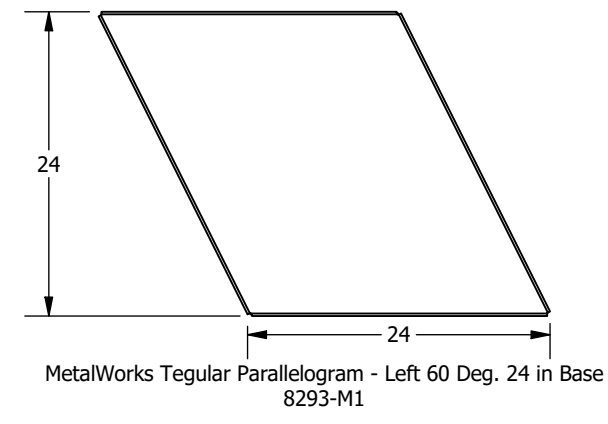
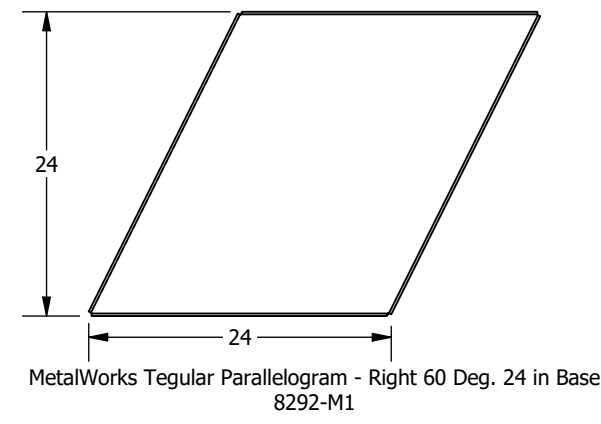
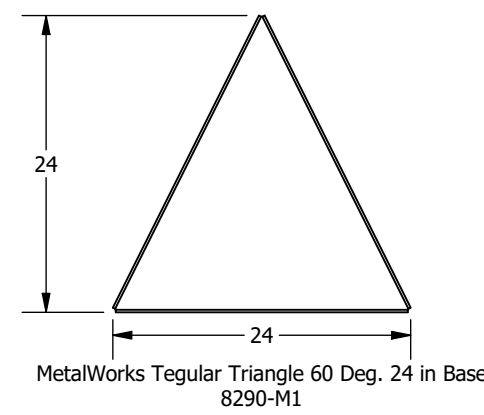

NOTES:
1. Views are from the face of the panel, and descriptions are based on these views
2. Dimensions are nominal and reflect grid spacings
3. Scale 1:15

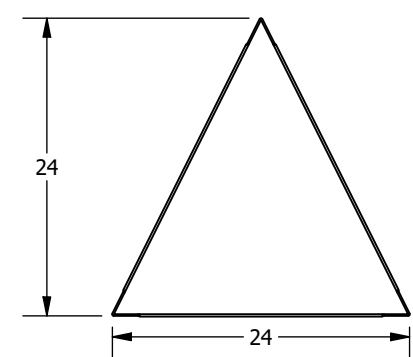

WoodWorks Tegular - 60 Deg. 24 in. Base Triangle
8277-W1

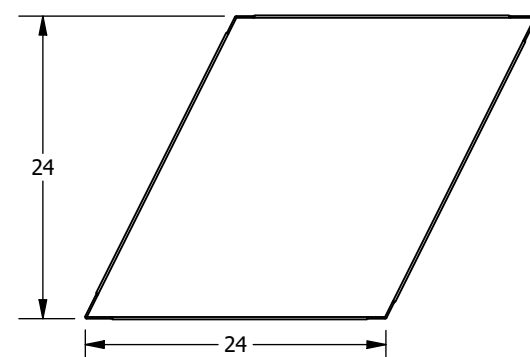

WoodWorks Tegular - 60 Deg. 24 in. Base Right Parallelogram
8279-W1

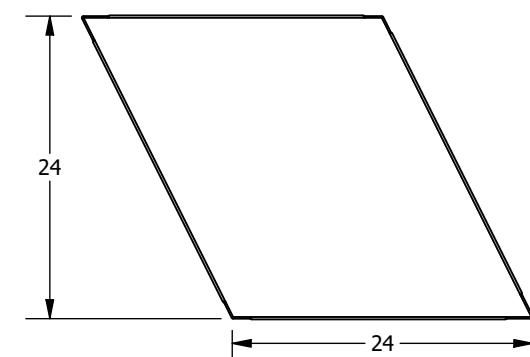

WoodWorks Tegular - 60 Deg. 24 in. Base Left Parallelogram
8280-W1

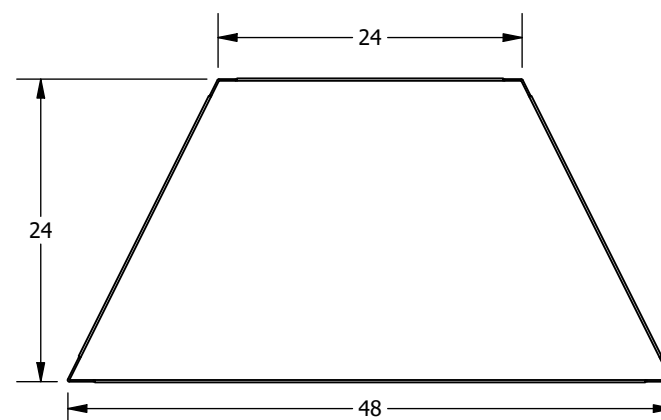

WoodWorks Tegular - 60 Deg. 48 in. Base Trapezoid
8281-W1

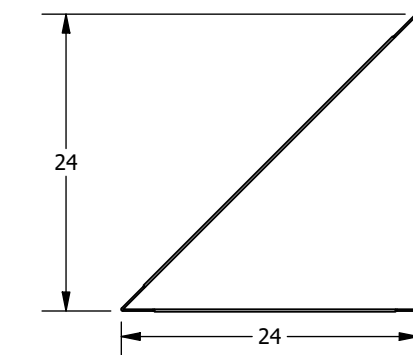

WoodWorks Tegular - 45 Deg. 24 in. Base Right Rt. Triangle
8272-W1

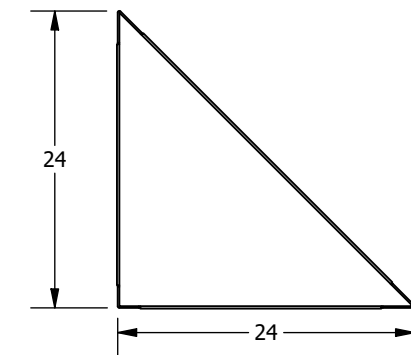

WoodWorks Tegular - 45 Deg. 24 in. Base Left Rt. Triangle
8282-W1

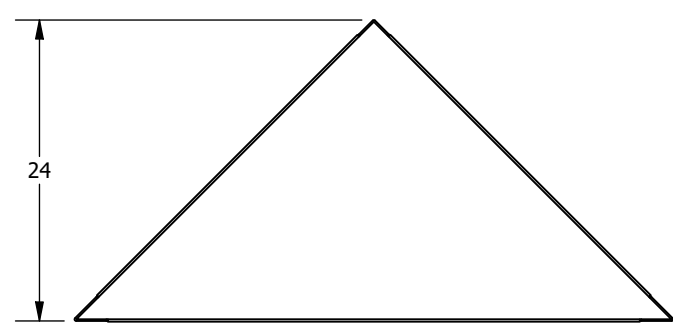

WoodWorks Tegular - 45 Deg. 48 in. Base Triangle
8271-W1

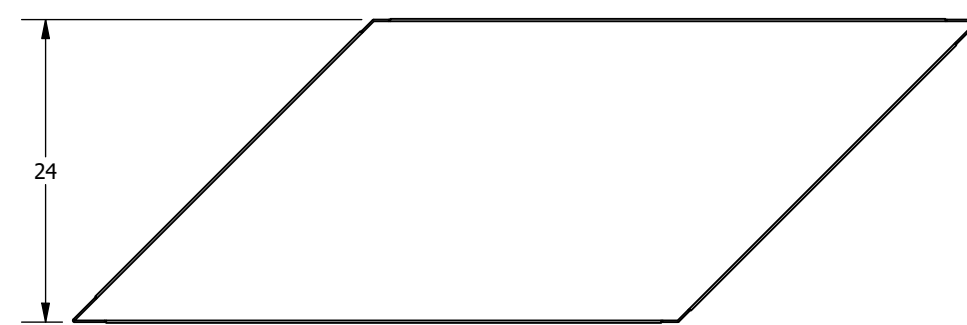

WoodWorks Tegular - 45 Deg. 48 in. Base Right Parallelogram
8274-W1

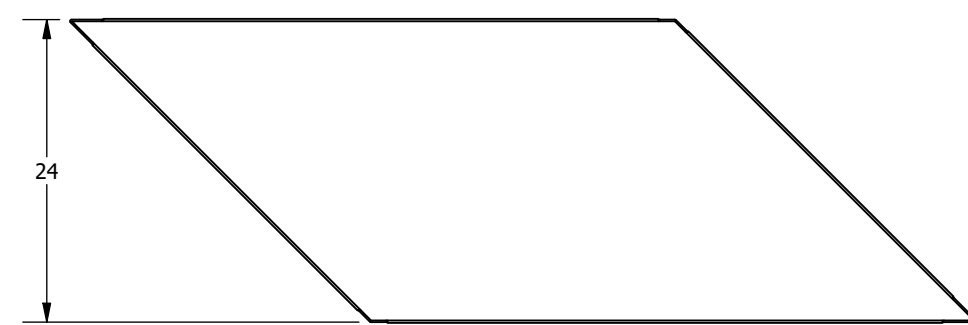

WoodWorks Tegular - 45 Deg. 48 in. Base Left Parallelogram
8275-W1

NOTES:

1. Views are from the face of the panel, and descriptions are based on these views
2. Dimensions are nominal and reflect grid spacings
3. Scale 1:15



DesignFlex - Panels WoodWorks Shapes

DRAWN BY: RDH DATE: 8/5/2020 PD

These drawings show typical conditions which the Armstrong products depicted are installed. They are not a substitute for an architect's or engineer's plan and do not reflect the unique requirements of local building codes, laws, statutes, ordinances, rules and regulations (Legal Requirements) that may be applicable for a particular installation. Armstrong does not warrant, and assumes no liability for the accuracy or completeness of the drawings for a particular installation or their fitness for a particular purpose. The user is advised to consult with a duly licensed architect or engineer in the particular locale of the installation to assure compliance with all legal requirements. Armstrong is not licensed to provide professional architecture or engineering design services.