

NOTES:  
 THE EXAMPLE LAYOUT AND CORRESPONDING BOM SHOWN ARE MEANT TO BE USED AS REFERENCE POINTS WHEN SPECIFYING A DESIGNFLEX SYSTEM.  
 IF YOU PLAN TO USE THE EXACT LAYOUT SHOWN, OR ANY VARIATION THEREOF, CONSIDER THE FOLLOWING NOTES:

- 1) DRAWING DETAILS SHOW A CEILING PLAN VIEW WHICH IS FROM A PLENUM POSITION LOOKING DOWN ONTO THE BACKSIDE OF THE CEILING SYSTEM. BOM LISTS DESCRIPTIONS THAT COORDINATE WITH THE DATA PAGES, AND THESE ITEM DESCRIPTIONS ARE BASED ON VIEWING THE FACE OF THE PRODUCTS.
- 2) ANGLE BRACKETS AND CORNER BRACKETS ARE INSTALLED AT STANDARD 6" OC ROUTE HOLE INCREMENTS ALONG THE MAIN BEAMS - ALL MAIN BEAMS ARE INSTALLED WITH ALIGNED ROUTE HOLES.
- 3) ANGLE BRACKETS USED WITHIN LAYOUTS HAVE SCREWS, WASHERS, AND NUTS INCLUDED WITH THEM FOR FASTENING TO MAIN BEAMS. IF CORNER BRACKETS ARE USED IN THE SYSTEM THEY WILL REQUIRE SCREWS THAT ARE NOT INCLUDED AND NEED TO BE SUPPLIED BY OTHERS.
- 4) SCREWS, RIVETS, AND OTHER GENERAL FASTENERS THAT ARE NOT INCLUDED IN BOM OR IN DETAILS BELOW, NEED TO BE SUPPLIED BY OTHERS. REFER TO INSTALLATION INSTRUCTIONS FOR DETAILS ON REQUIRED FASTENERS.
- 5) HANGER WIRE LOCATIONS SHOWN BELOW ARE ONLY SUGGESTIONS BASED ON EXAMPLE LAYOUT AND CAN BE MOVED IN ACCORDANCE WITH FOLLOWING REQUIREMENT - HANGER WIRES ARE REQUIRED ALONG MAINS WITHIN 24" OF THE WALL AND NO MORE THAN 48" O.C THEREAFTER.
- 6) CONDITIONS SHOWN ARE FOR NON-SEISMIC INSTALLATIONS (SEISMIC DESIGN CATEGORY A,B) - REFERENCE INSTALLATION INSTRUCTIONS FOR CONSIDERATIONS AND REQUIREMENTS FOR SEISMIC INSTALLATIONS.
- 7) DETAILS BELOW AND BOM ARE SUBJECT TO CHANGES AT THE PERIMETER BASED ON THE LAYOUT (LINEAR FEET OF PERIMETER, FULL SIZE VS. CUT PANELS, BORDER PANEL INSTALLATION METHOD).
- 8) 7800 WALL ANGLE PERIMETER SHOWN BELOW. REFERENCE INSTALLATION INSTRUCTIONS FOR DETAILS ON ALTERNATIVE PERIMETER SOLUTIONS.
- 9) BOM DOES NOT ACCOUNT FOR THE USE OF SCRAP OR EXCESS MATERIAL CUT FROM OTHER ITEMS.
- 10) REFER TO MASTER PARTS SHEET, PANEL SHEET, AND INSTALLATION INSTRUCTIONS ILLUSTRATIONS SHEET FOR SPECIFIC DETAIL VIEWS AND DIAGRAMS OF ALL PARTS AND PIECES LISTED IN BOM.

SH-0038-3 BILL OF MATERIALS				
ITEM	QTY	STOCK NUMBER	DESCRIPTION	
1	16	7800	Angle Molding	
2	76	7500/7501	12" ID/HD Suprafine Main Beam	
3	246	75AB60L	Suprafine 60 Deg. Left Angle Bracket	
4	246	75AB60R	Suprafine 60 Deg. Right Angle Bracket	
5	248	75AB60D	Suprafine 60 Deg. Double Angle Bracket	
6	520	XM756024	Suprafine 60 Deg. Cross Tee - 24in MBS	
7	90	BERC2	2" Beam End Retaining Clip	
8	260	100002	Lyra 9/16" Square Tegular - 60 Deg. 24 in Base Triangle	
9	140	100016	Lyra 9/16" Square Tegular - 60 Deg. 24 in Base Right Parallelogram	
10	140	100017	Lyra 9/16" Square Tegular - 60 Deg. 24 in Base Left Parallelogram	
11	209	7891	12 Gauge Hanger Wire (Qty. = number of min. hanging point locations)	

EXAMPLE LAYOUT AND BOM SHOWN WITH LYRA PANELS AND SUPRAFINE SUSPENSION SYSTEM

PANEL PRODUCT FAMILIES COMPATIBLE WITH THIS LAYOUT:  
 LYRA, OPTIMA, CALLA, METALWORKS TEGULAR, AND WOODWORKS TEGULAR

SUSPENSION SYSTEMS COMPATIBLE WITH THIS LAYOUT:  
 SUPRAFINE ID/HD

**SIDE A** - REPRESENTS A BORDER CONDITION UTILIZING A SINGLE GRID MEMBER CONNECTION TO THE PERIMETER

**SIDE B** - REPRESENTS A BORDER CONDITION UTILIZING A SINGLE GRID MEMBER CONNECTION OR MULTIPLE GRID MEMBER CONNECTIONS TO THE PERIMETER

REFERENCE INSTALLATION INSTRUCTIONS FOR FURTHER DETAILS ON HOW THESE BORDER CONDITIONS ARE INSTALLED

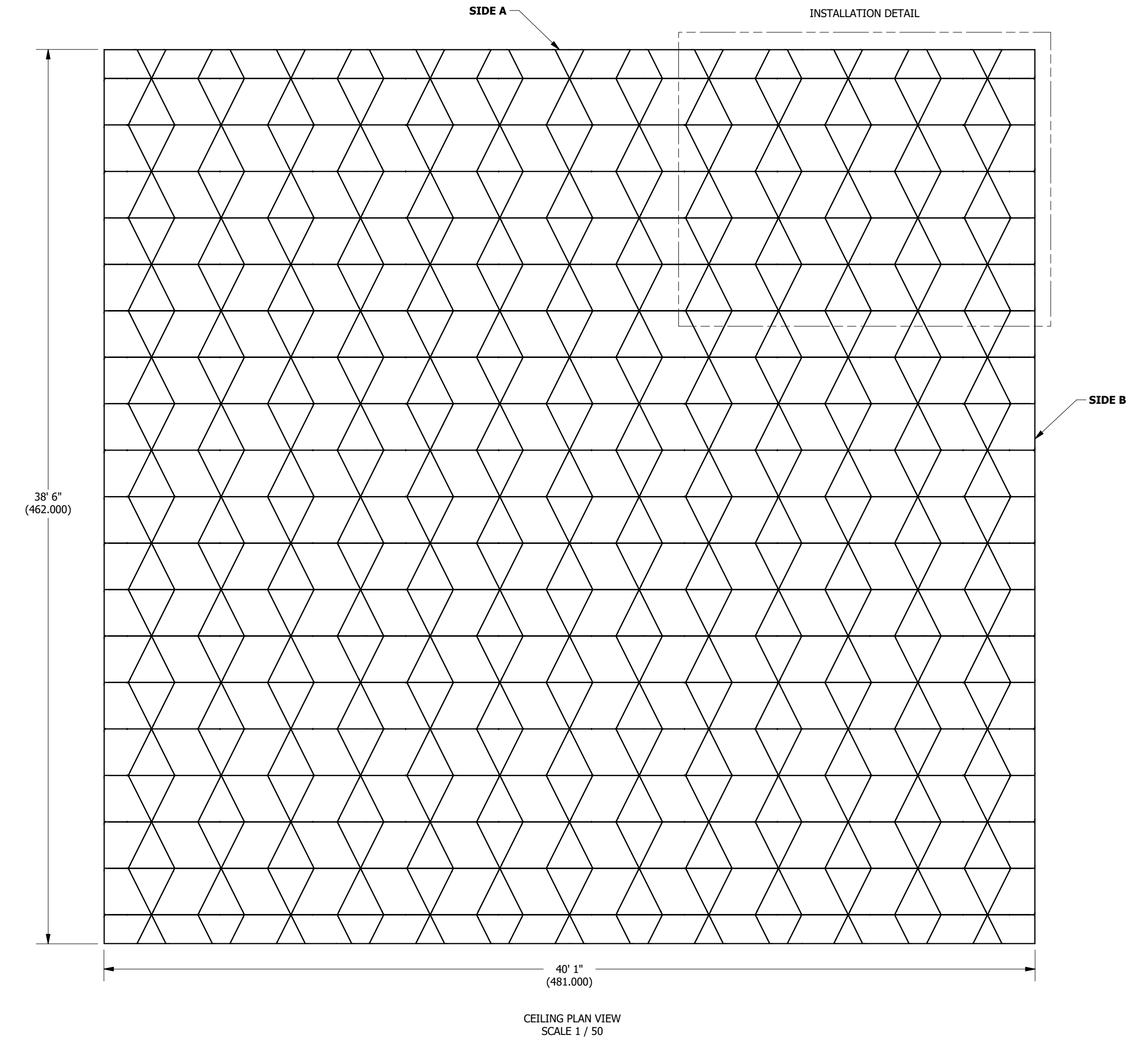
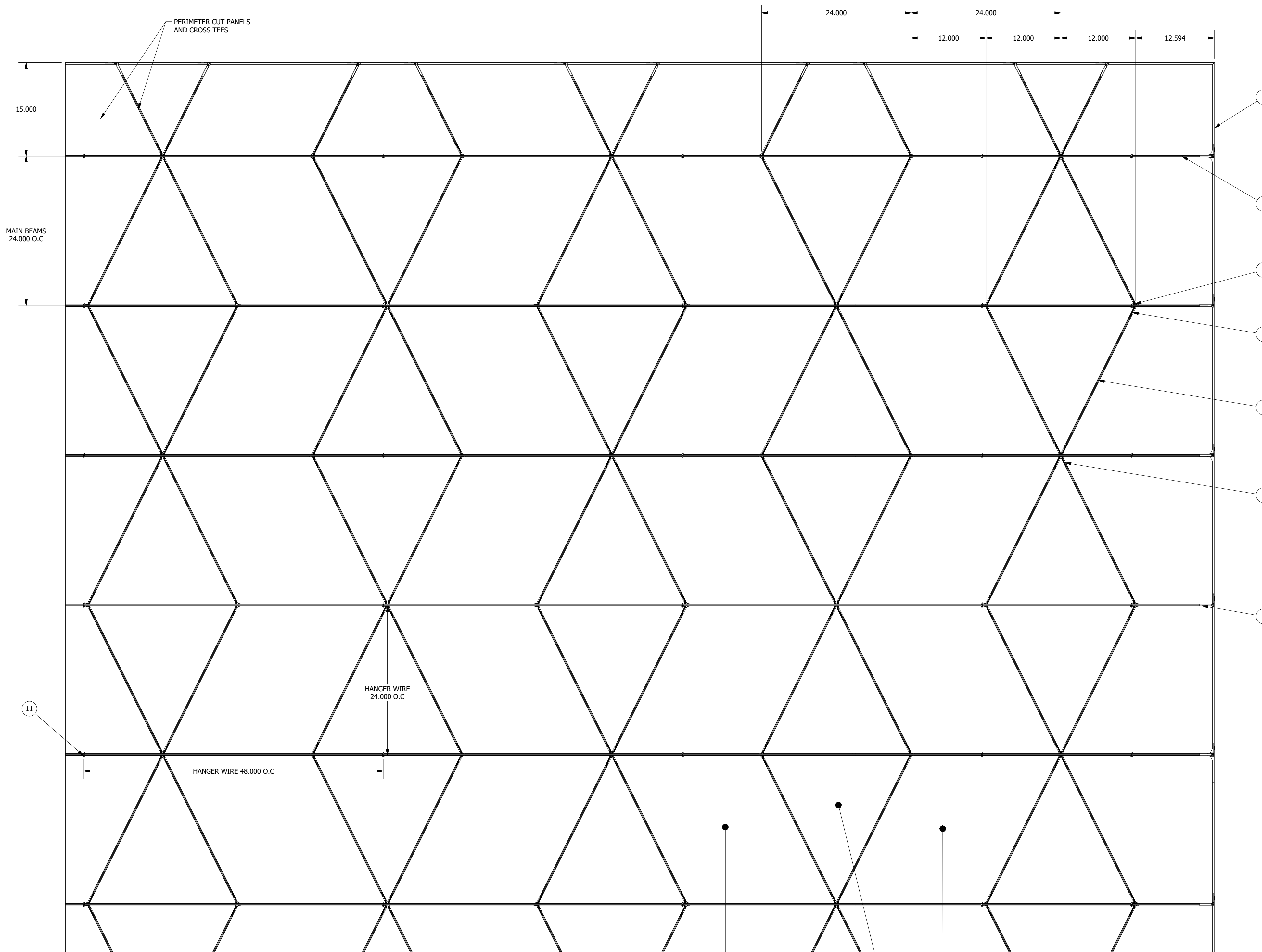

INSTALLATION DETAIL  
 SCALE 1 / 10



DESIGNFLEX SH-0038-3

DRAWN BY: NJF DATE: 10/2/2018 PD

These drawings show typical conditions which the Armstrong products depicted are installed. They are not a substitute for an architect's or engineer's plan and do not reflect the unique requirements of local building codes, laws, statutes, ordinances, rules and regulations (Legal Requirements) that may be applicable for a particular installation. Armstrong does not warrant, and assumes no liability for the accuracy or completeness of the drawings for a particular installation or their fitness for a particular purpose. The user is advised to consult with a duly licensed architect or engineer in the particular locale of the installation to assure compliance with all legal requirements. Armstrong is not licensed to provide professional architecture or engineering design services.

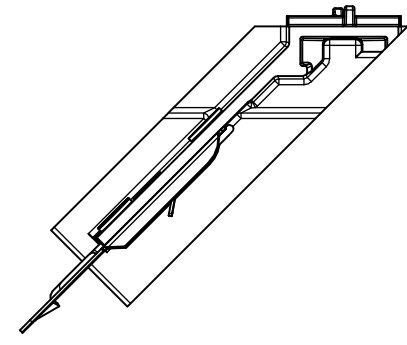

BP75AB45L Suprafine  
45° Left Angle Bracket

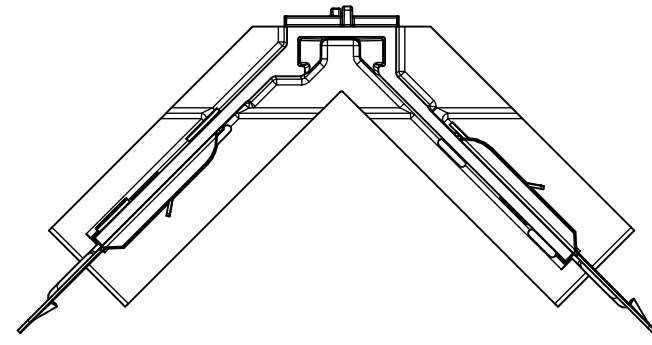

BP75AB45D Suprafine  
45° Double Angle Bracket

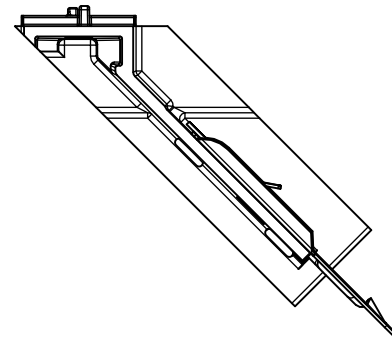

BP75AB45R Suprafine  
45° Right Angle Bracket

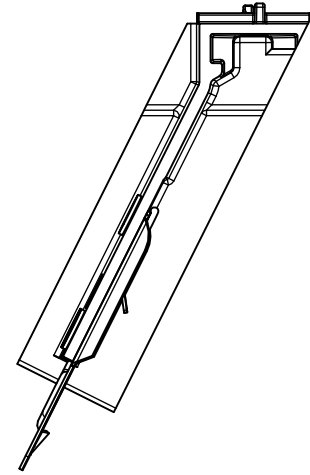

BP75AB60L Suprafine  
60° Left Angle Bracket

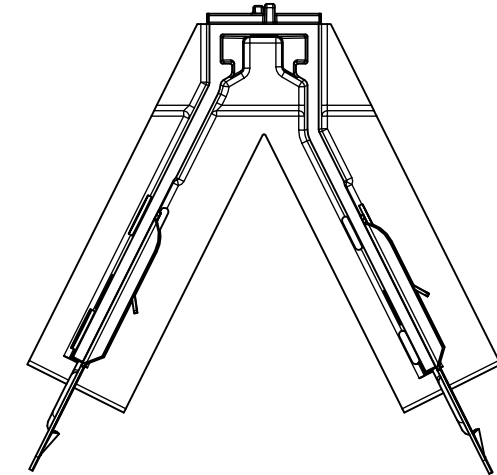

BP75AB60D Suprafine  
60° Double Angle Bracket

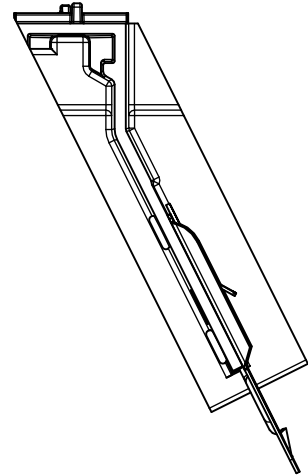

BP75AB60R Suprafine  
60° Right Angle Bracket

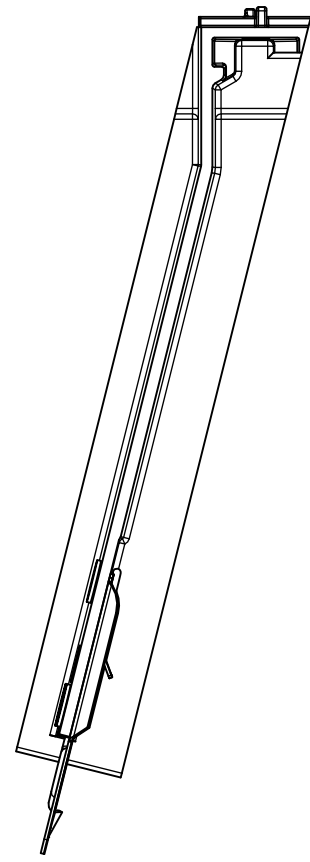

BP75AB75L Suprafine  
75° Left Angle Bracket

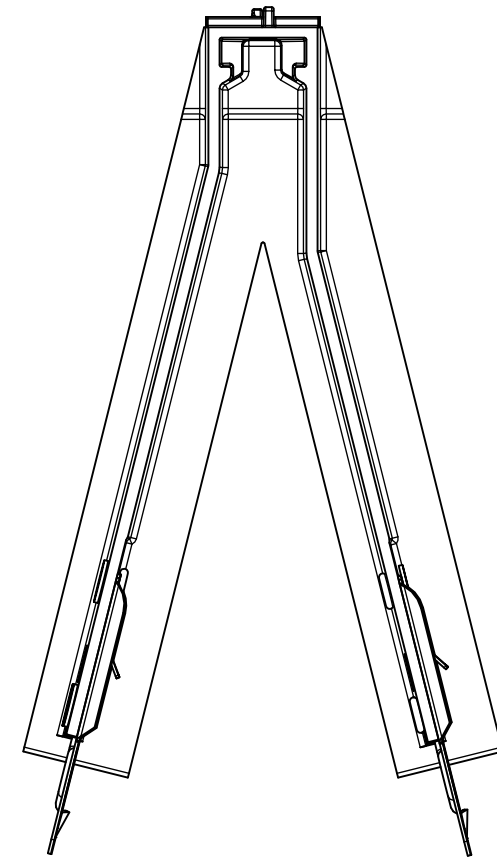

BP75AB75D Suprafine  
75° Double Angle Bracket

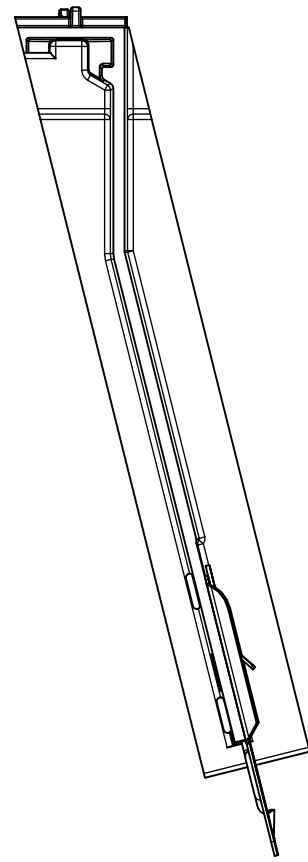

BP75AB75R Suprafine  
75° Right Angle Bracket

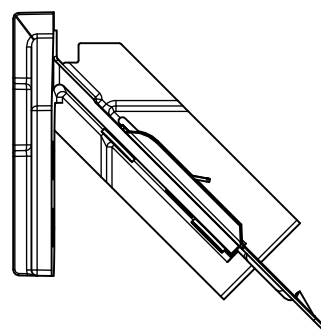

BP75CB45 Suprafine  
45° Corner Bracket

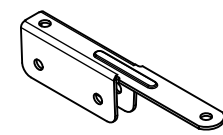

BPPAC  
Perimeter Angle Clip  
SCALE 1 / 2

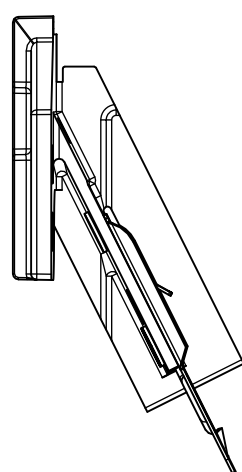

BP75CB60L Suprafine  
60° Left Corner Bracket

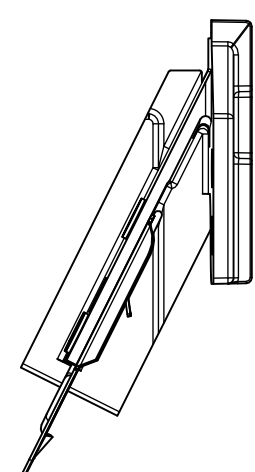

BP75CB60R Suprafine  
60° Right Corner Bracket

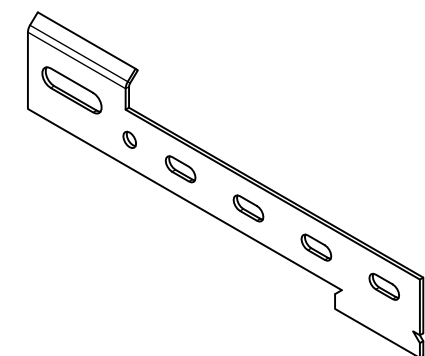

BPPCC  
Axiom Perimeter Corner Clip  
SCALE 1 / 2

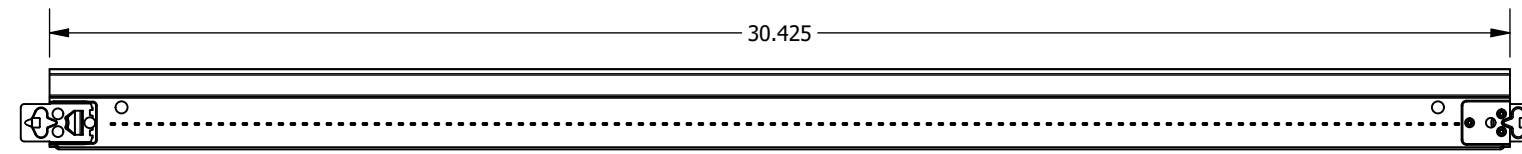

BPXM754524 Suprafine  
45° Cross Tee - 24" MBS  
SCALE 1 / 4

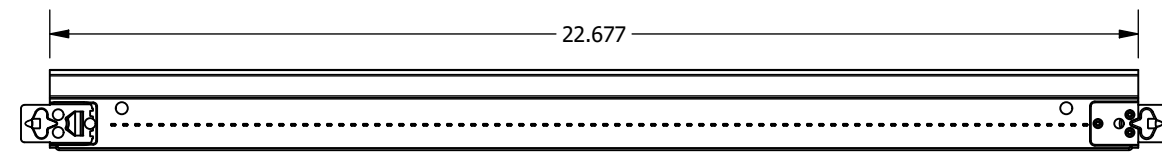

BPXM756024 Suprafine  
60° Cross Tee - 24" MBS  
SCALE 1 / 4

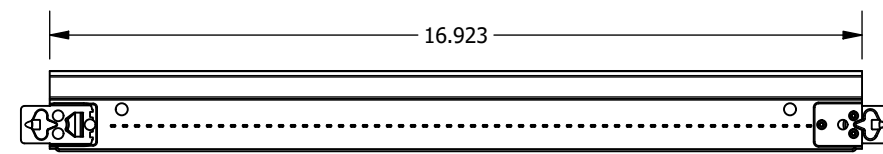

BPXM757524 Suprafine  
75° Cross Tee - 24" MBS  
SCALE 1 / 4

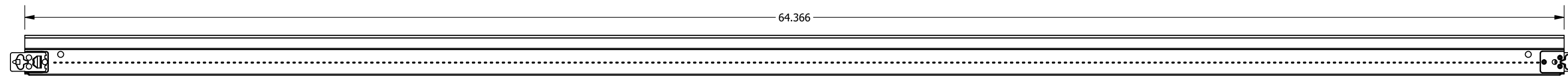

BPXM754548 Suprafine  
45° Cross Tee - 48" MBS  
SCALE 1 / 4

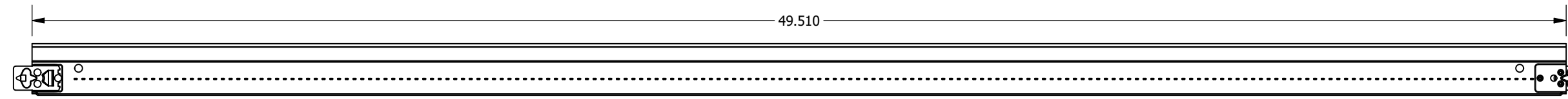

BPXM756048 Suprafine  
60° Cross Tee - 48" MBS  
SCALE 1 / 4

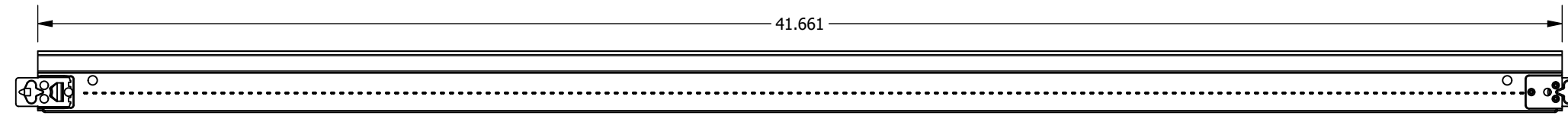

BPXM757548 Suprafine  
75° Cross Tee - 48" MBS  
SCALE 1 / 4

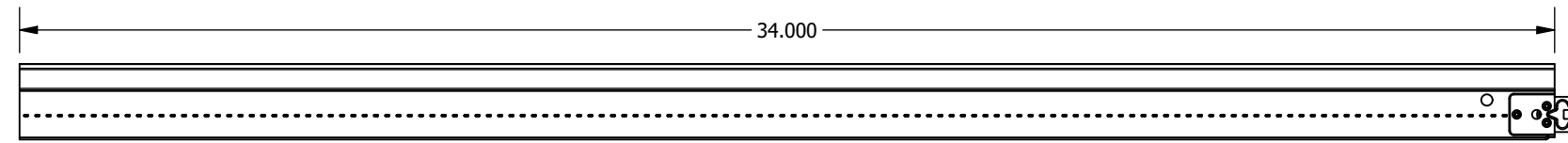

BPXM7524 Suprafine  
Perimeter Cross Tee - 24" MBS  
SCALE 1 / 4

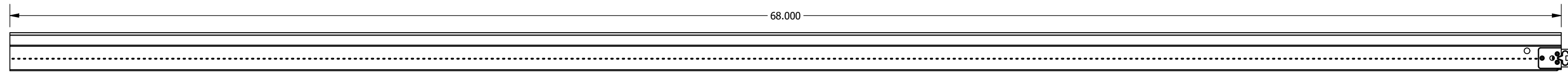

BPXM7548 Suprafine  
Perimeter Cross Tee - 48" MBS  
SCALE 1 / 4

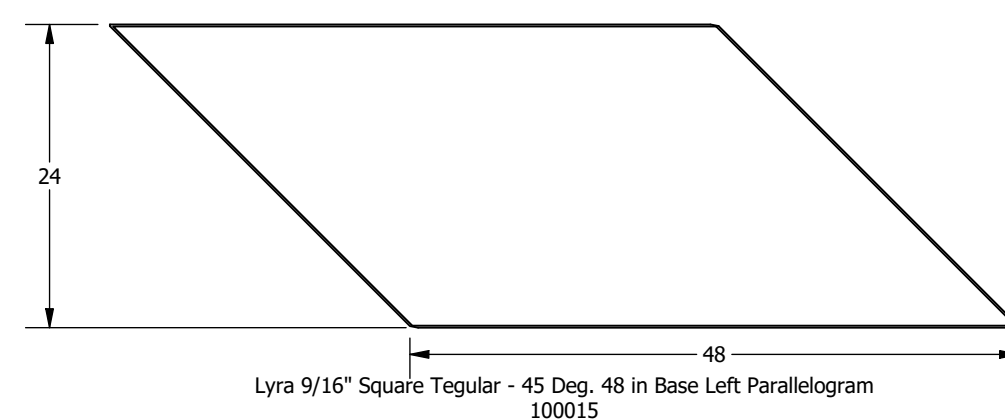
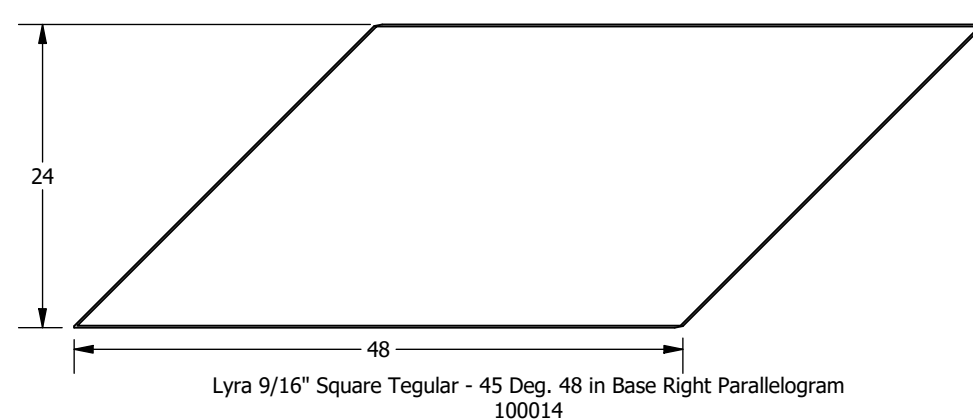
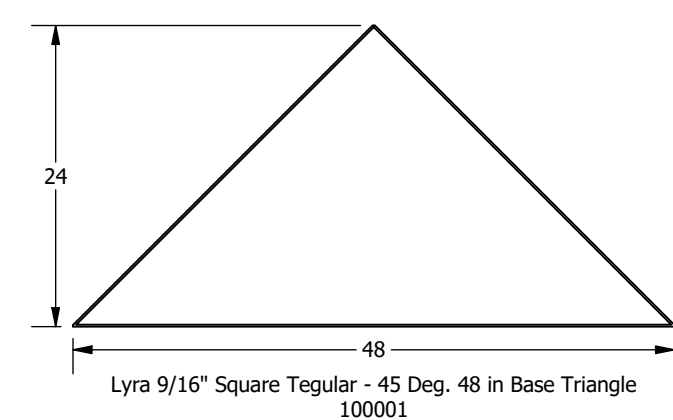
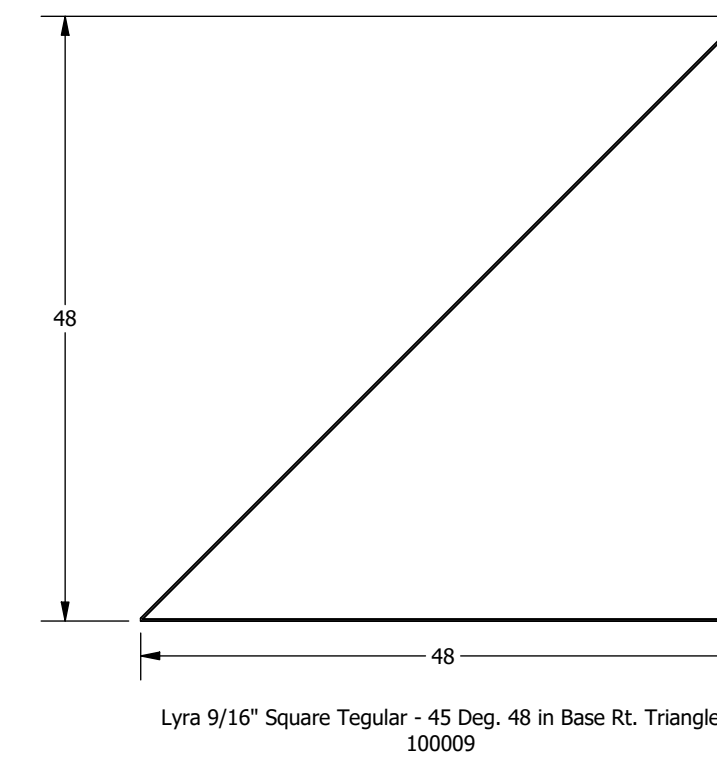
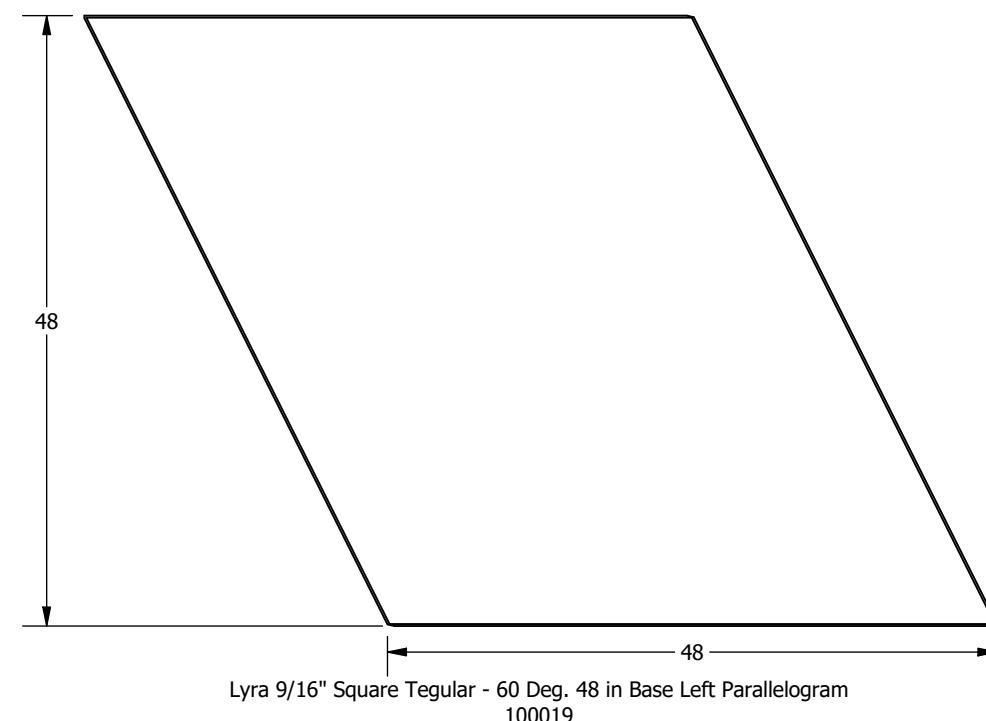
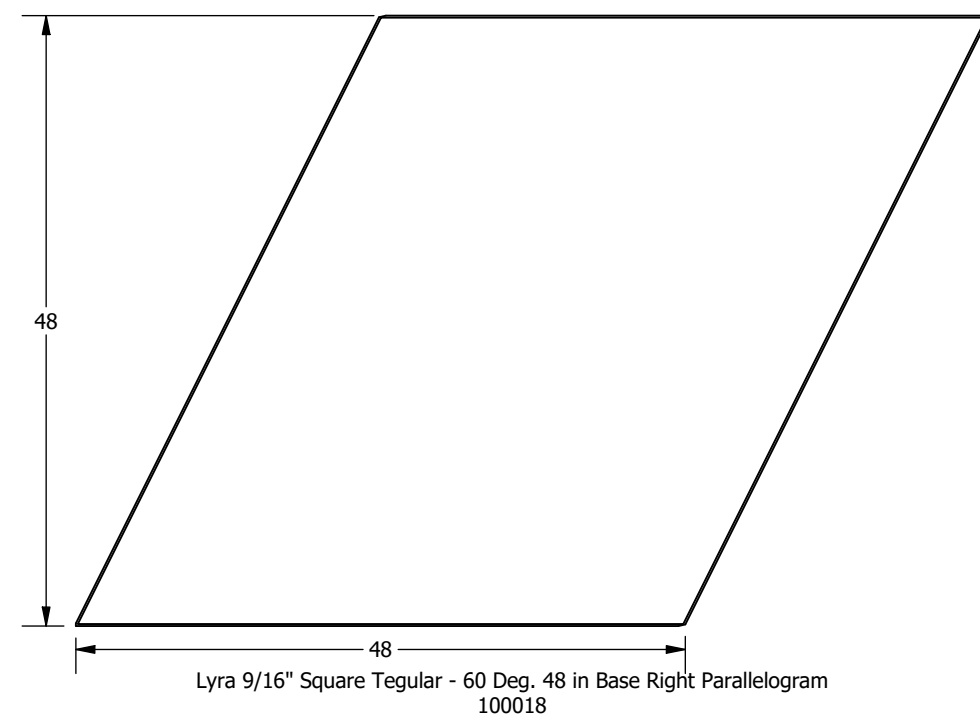
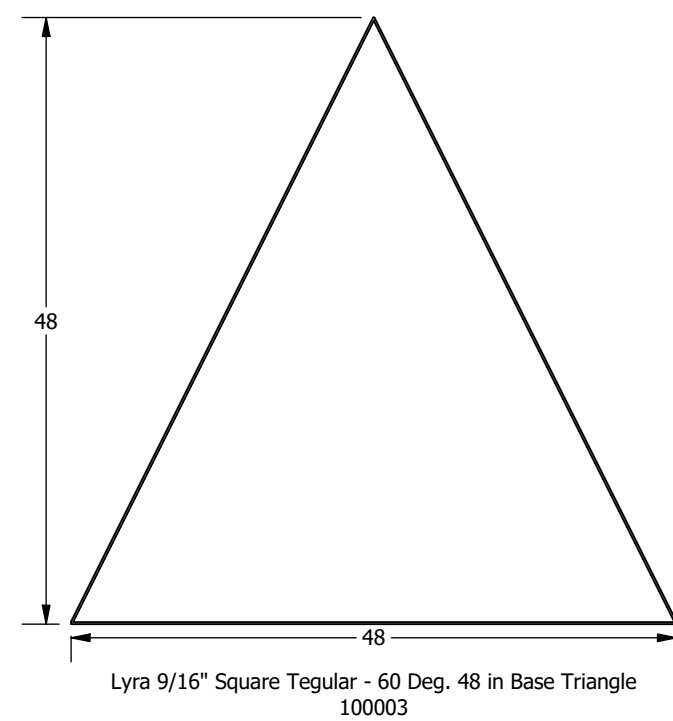
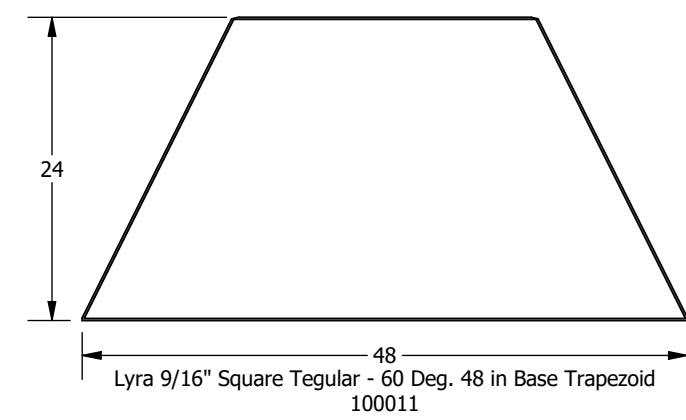
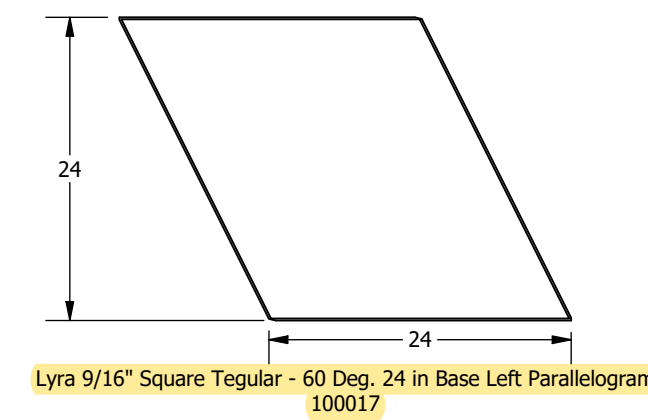
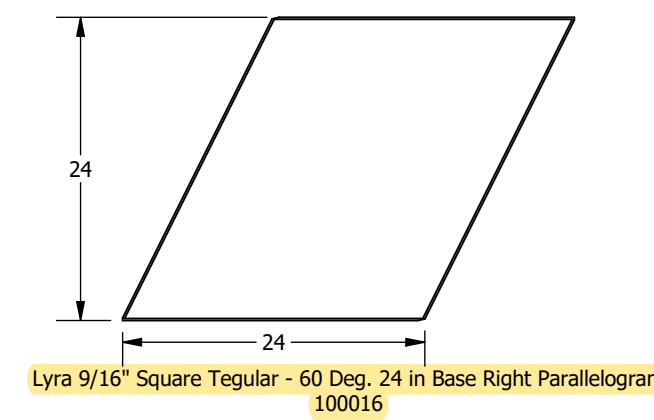
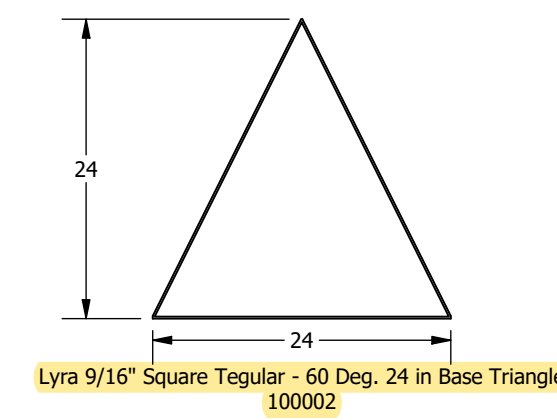
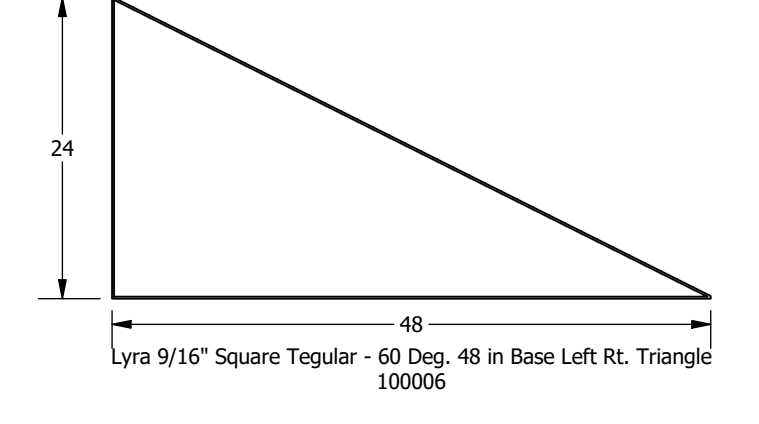
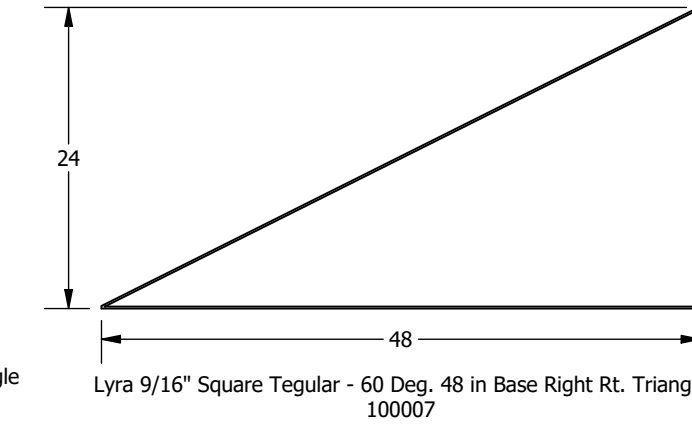
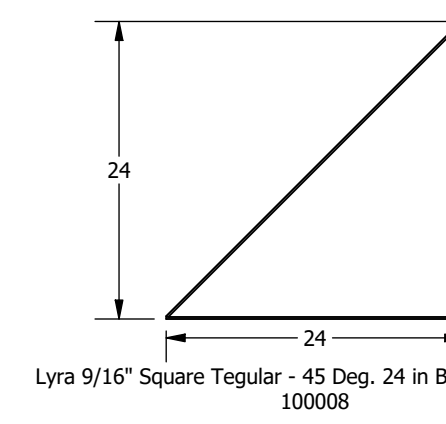
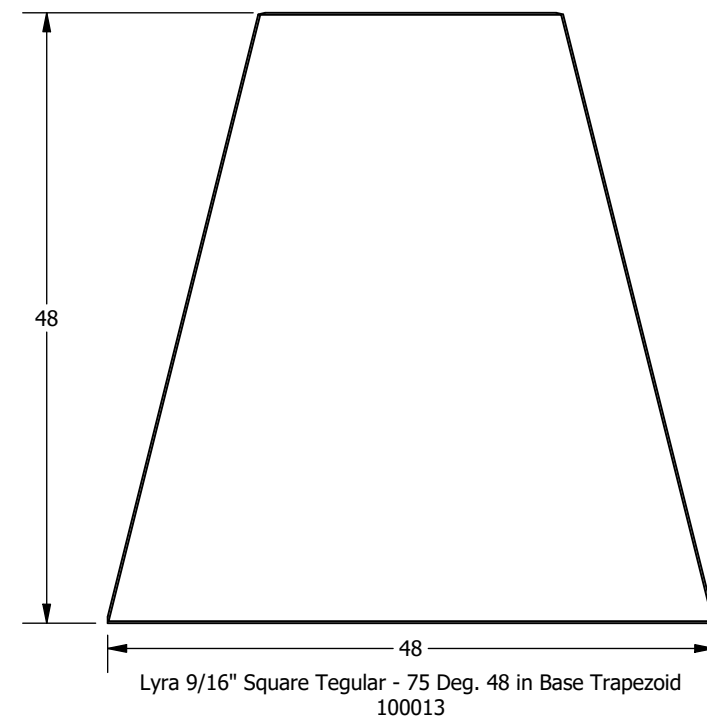
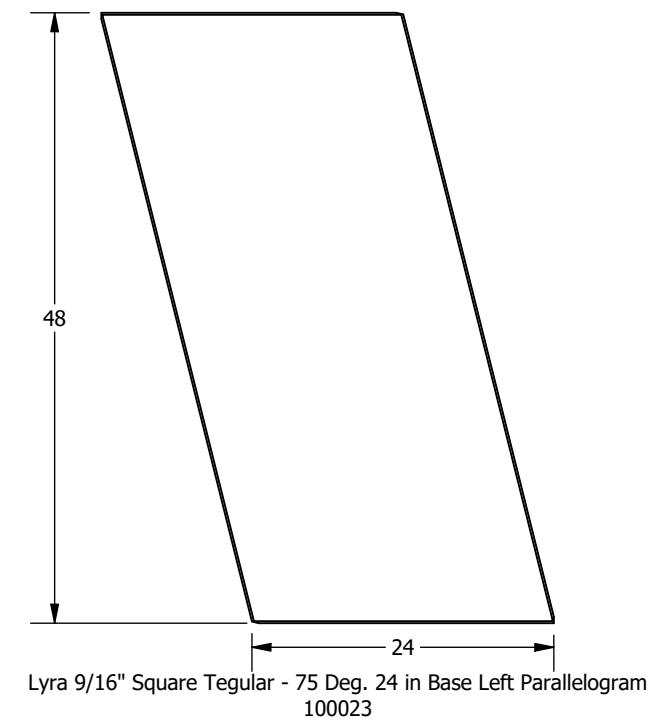
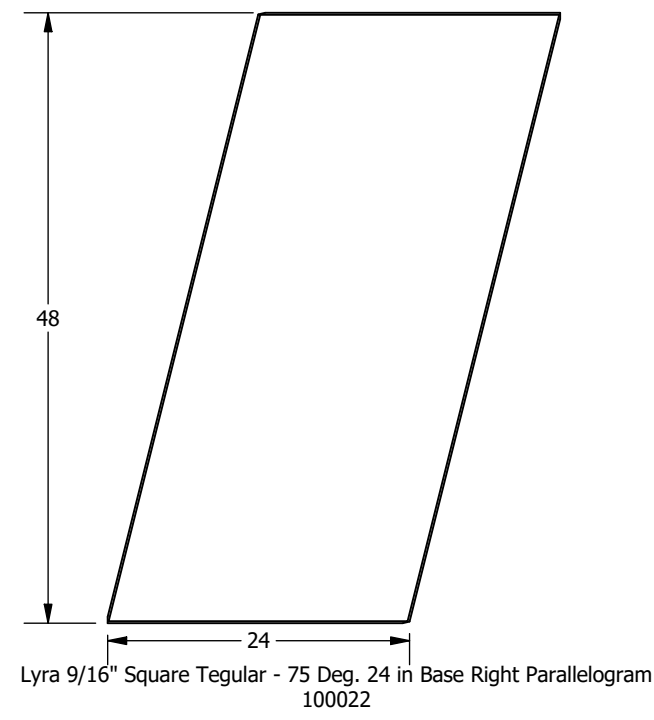
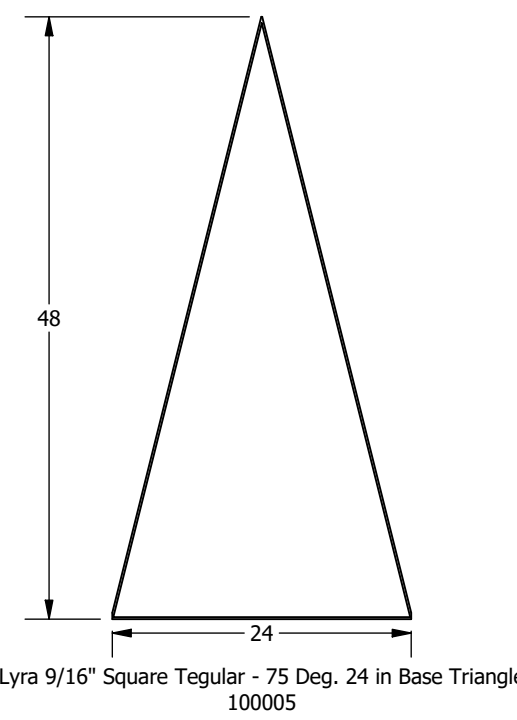
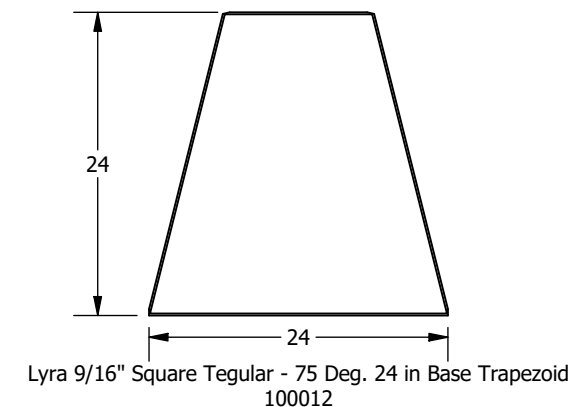
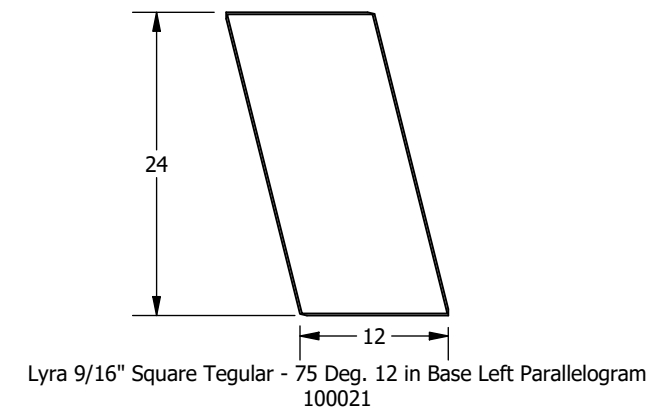
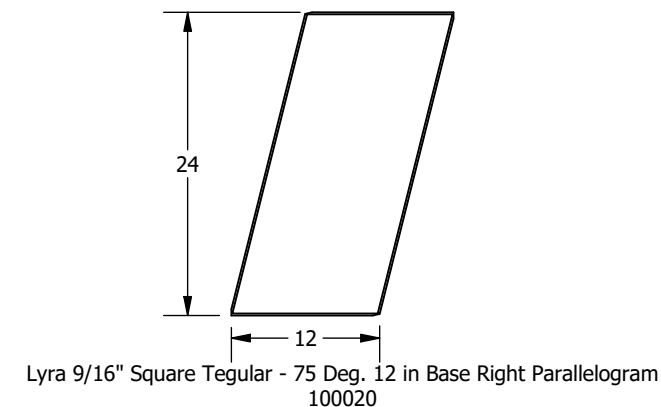
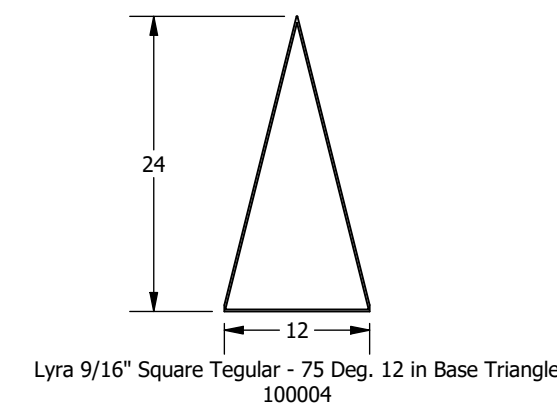

NOTES:  
1. Views are from the face of the panel, and descriptions are based on these views  
2. Dimensions are nominal and reflect grid spacings  
3. Scale 1:15

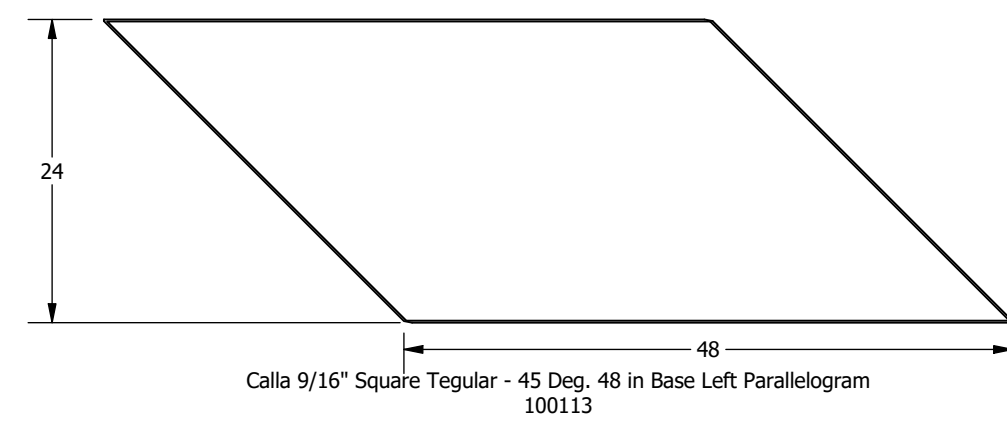
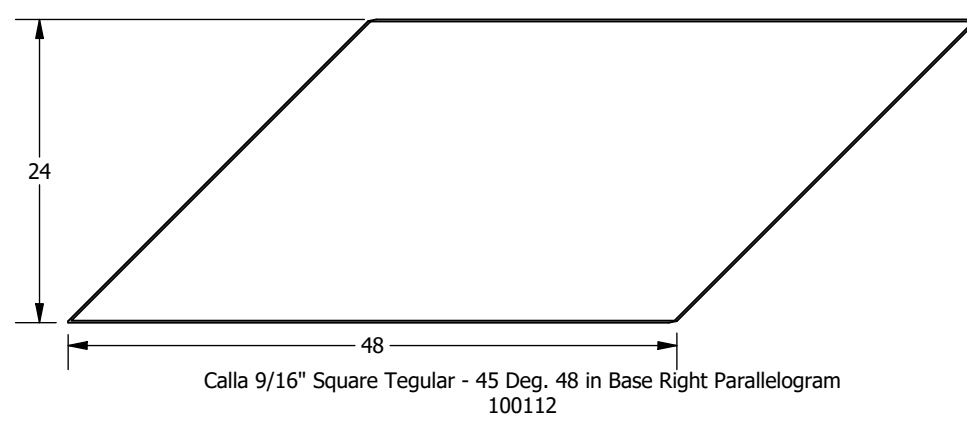
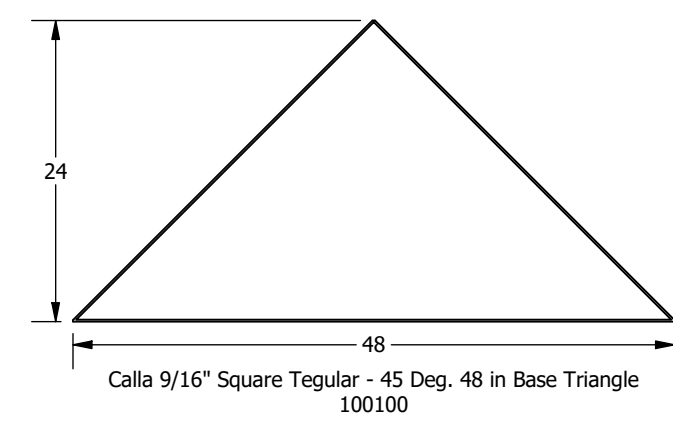
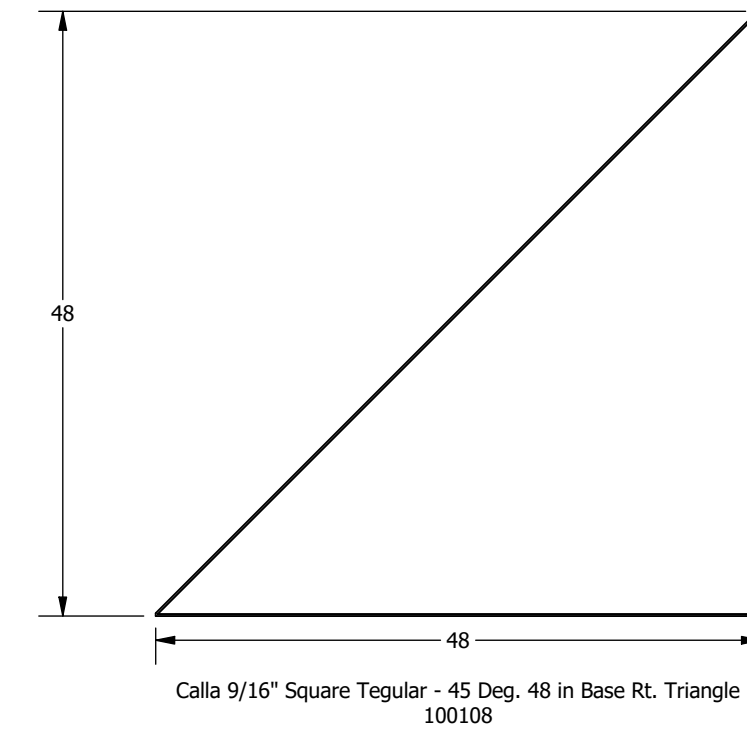
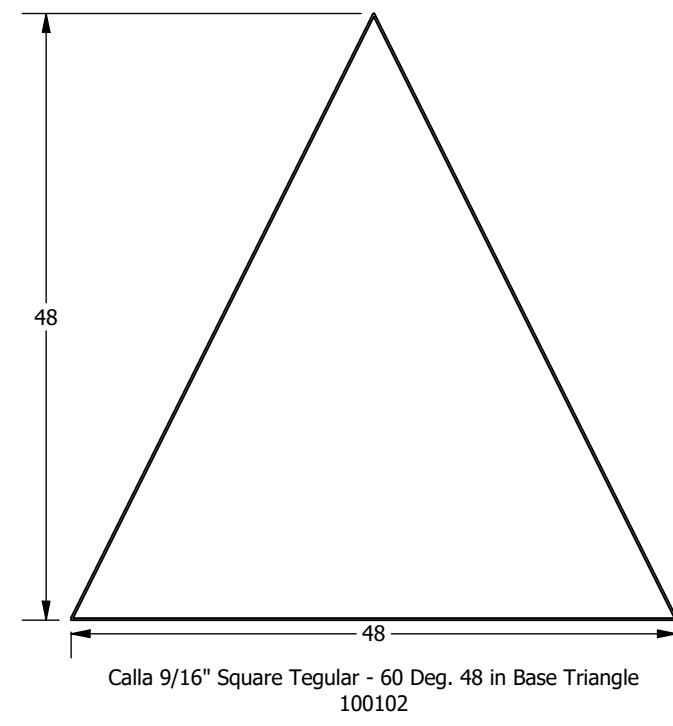
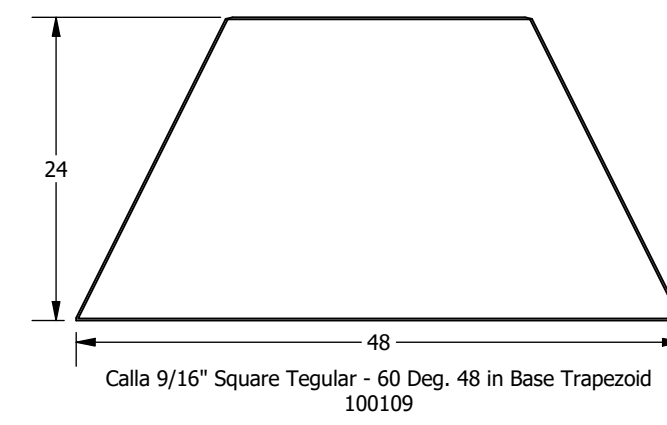
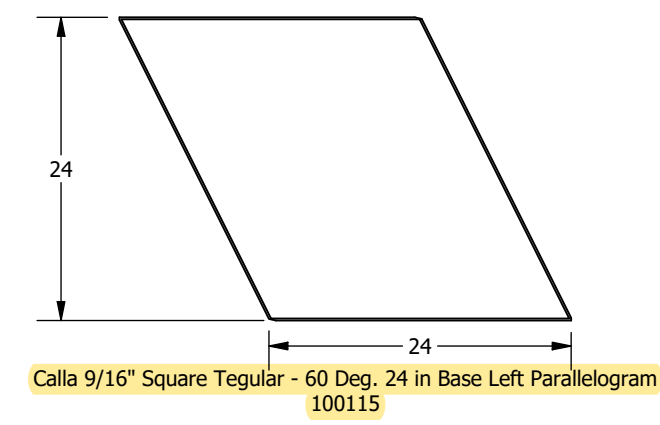
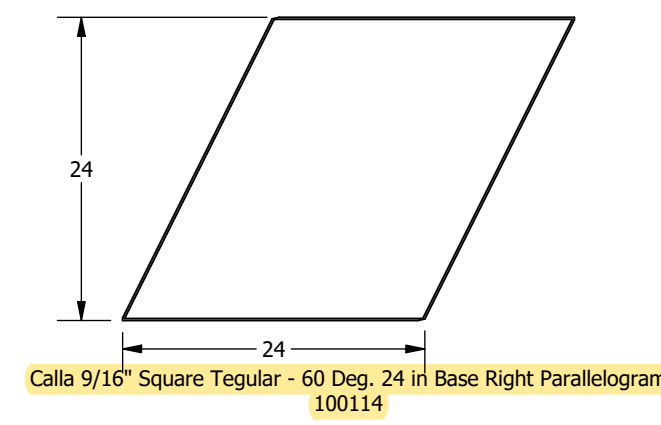
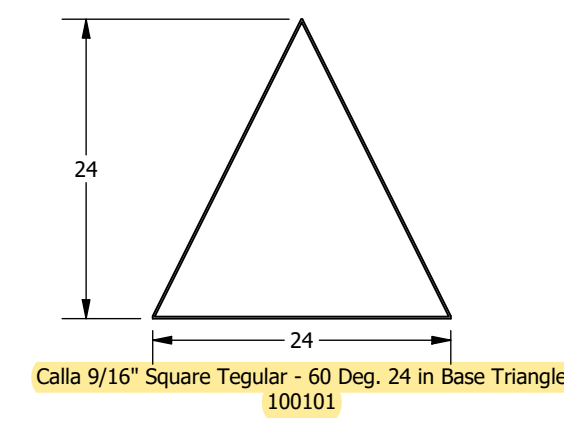
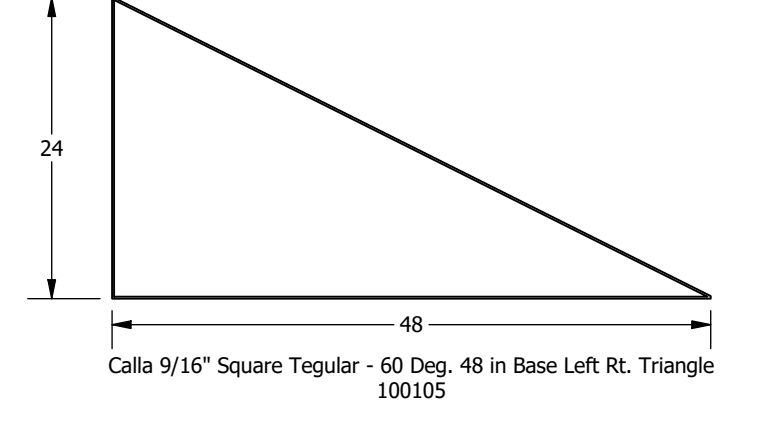
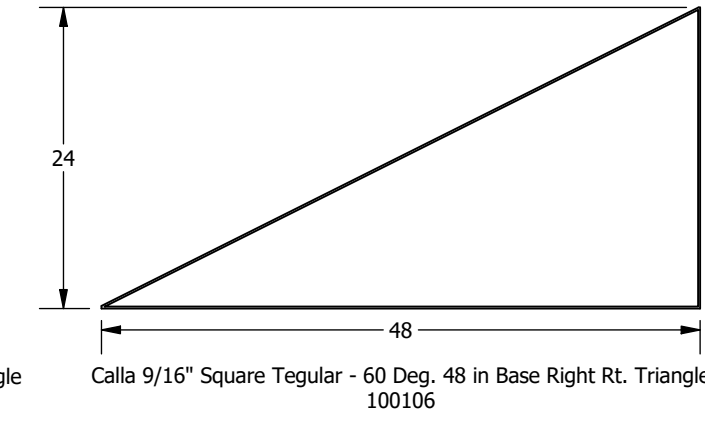
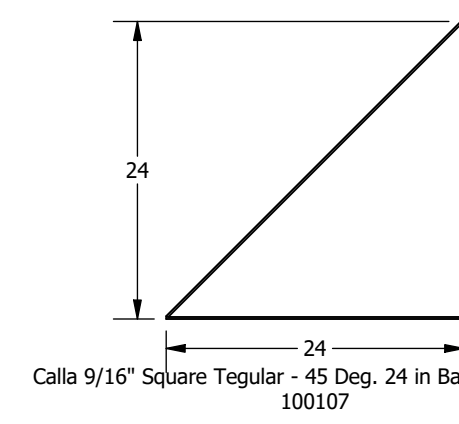
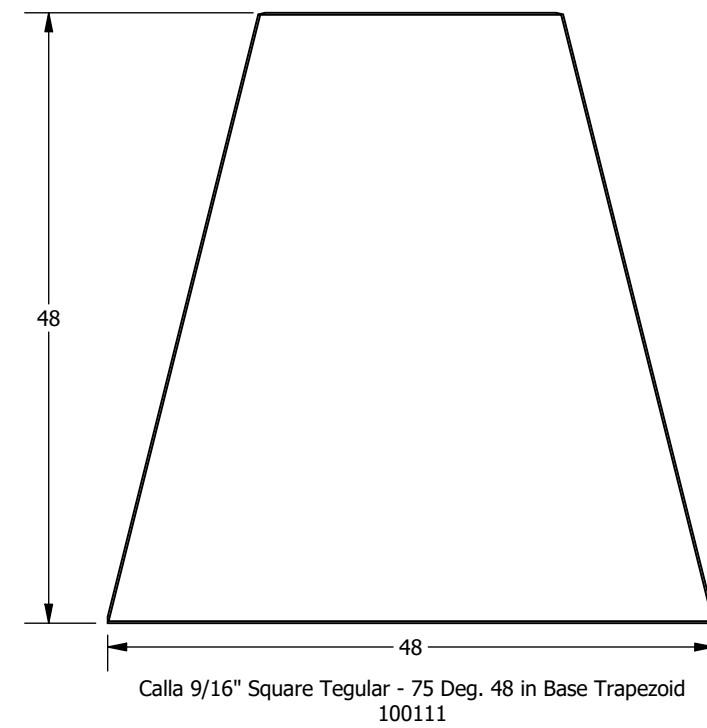
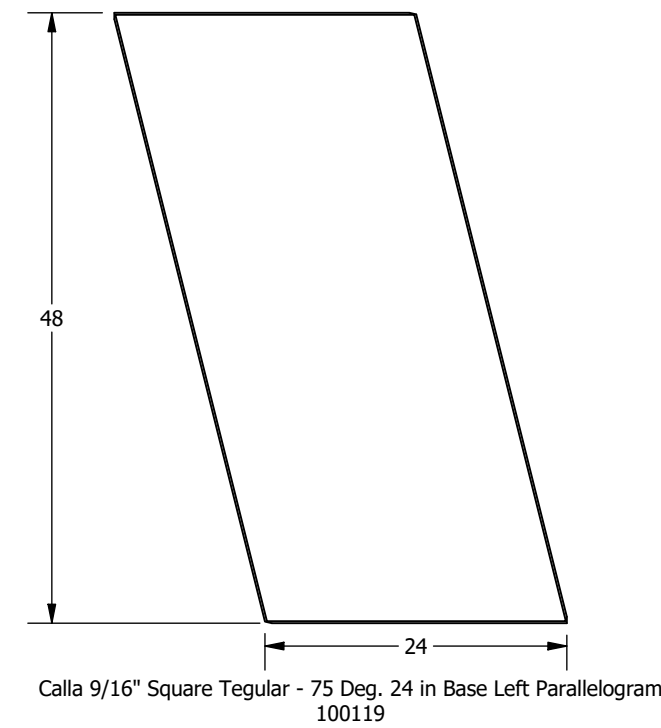
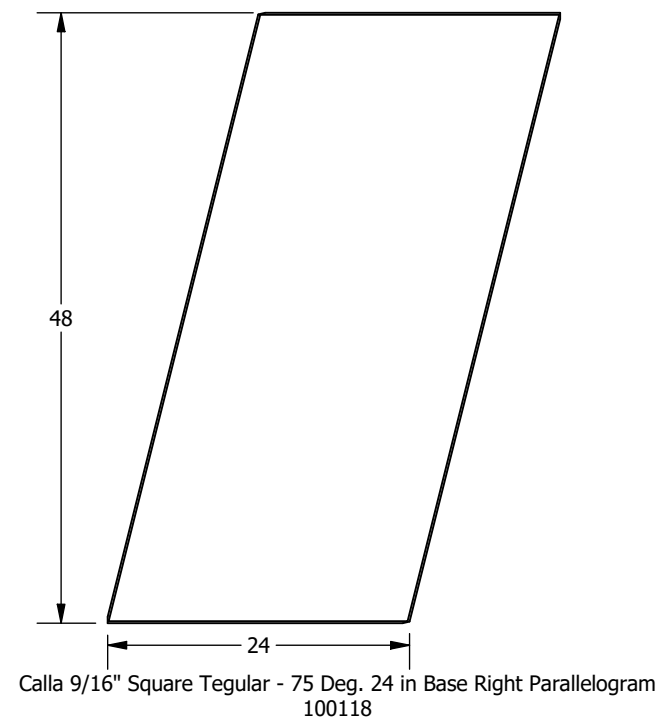
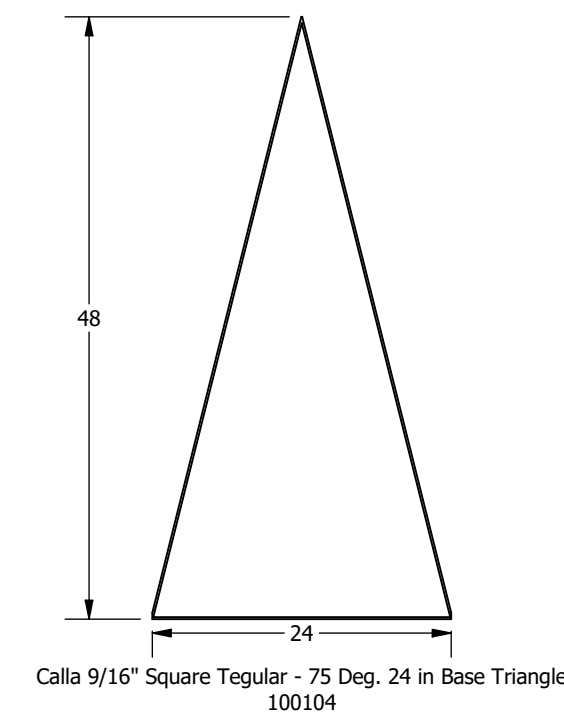
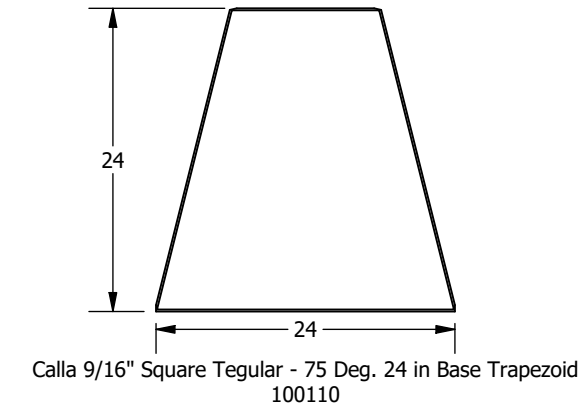
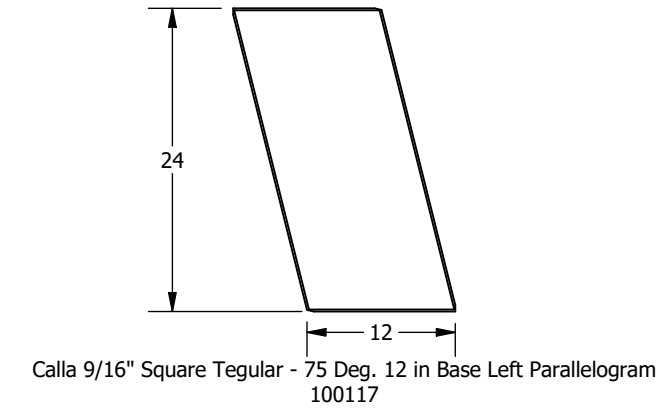
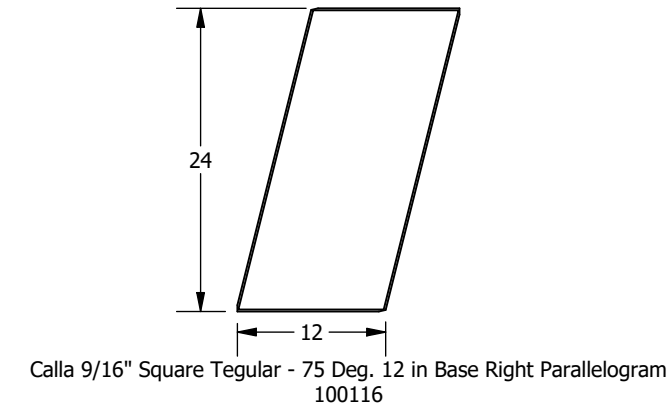
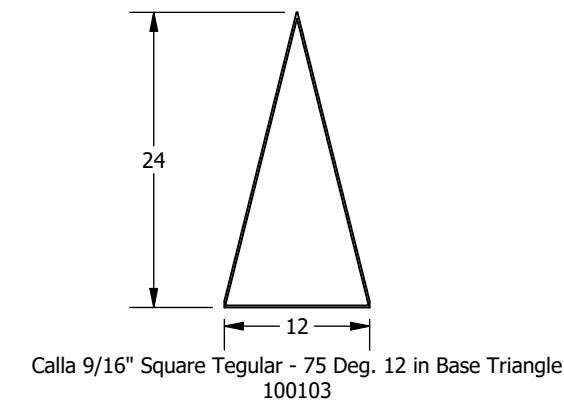

NOTES:  
1. Views are from the face of the panel, and descriptions are based on these views  
2. Dimensions are nominal and reflect grid spacings  
3. Scale 1:15



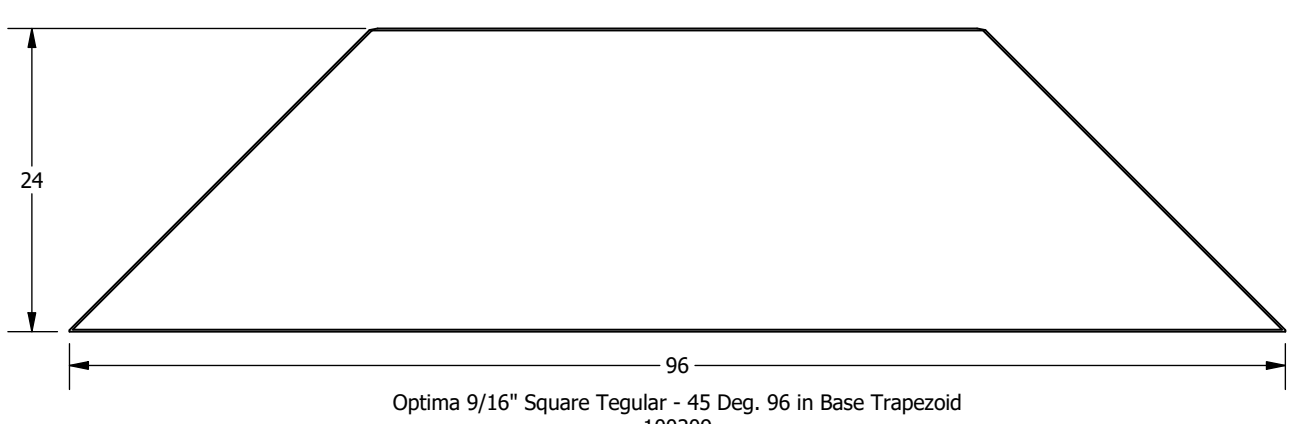
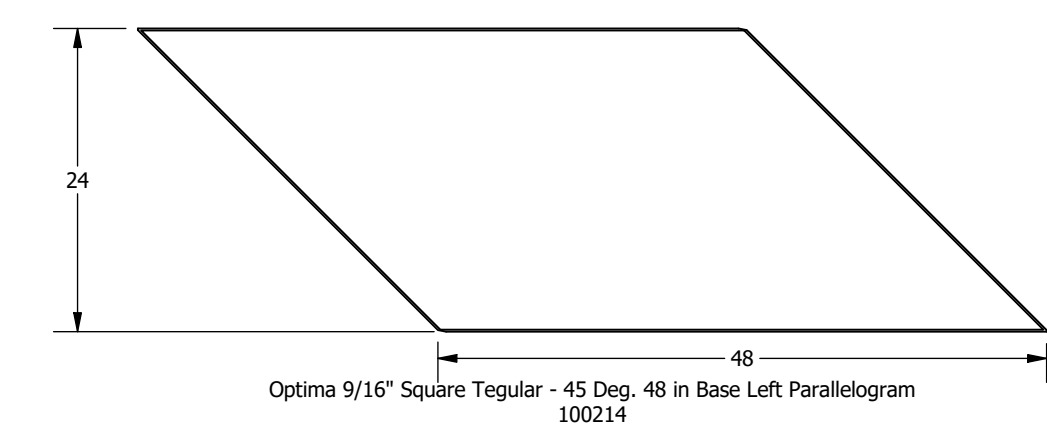
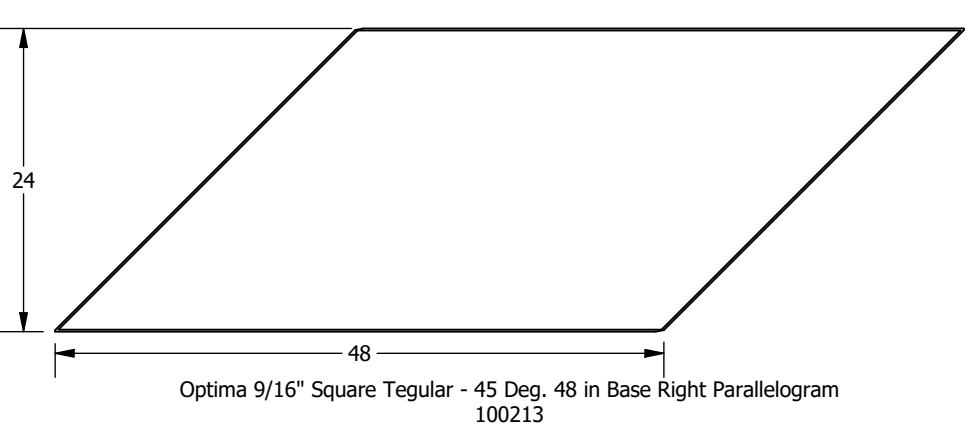
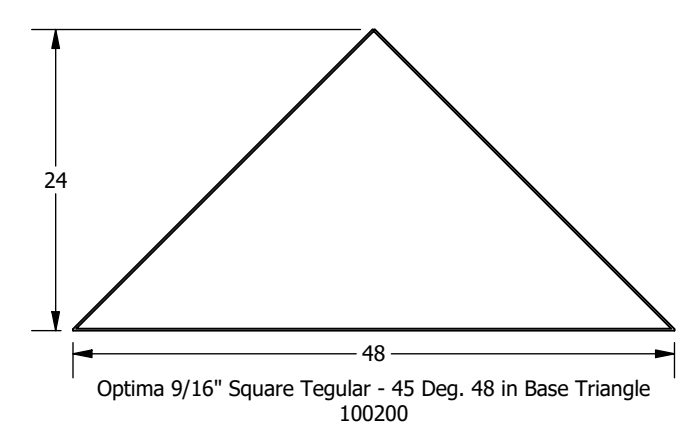
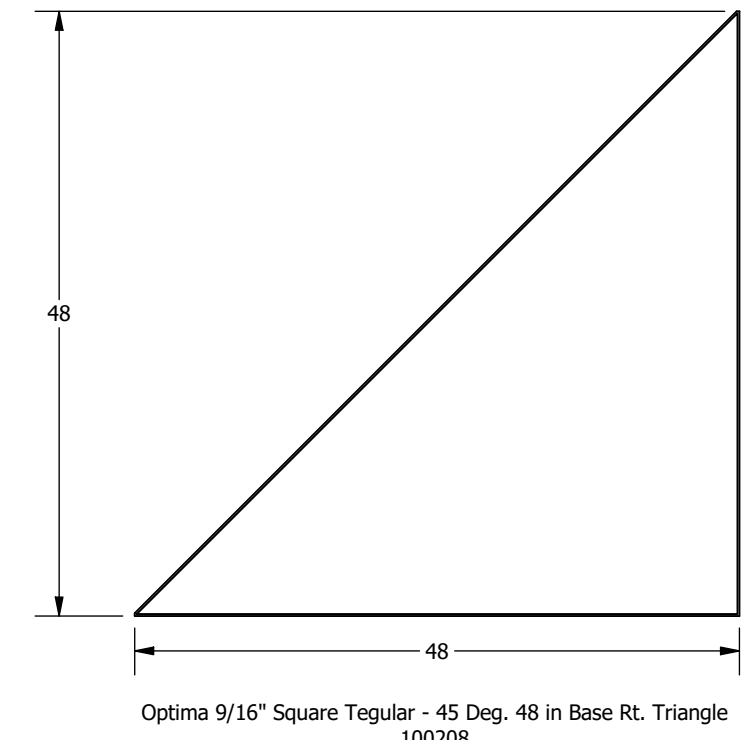
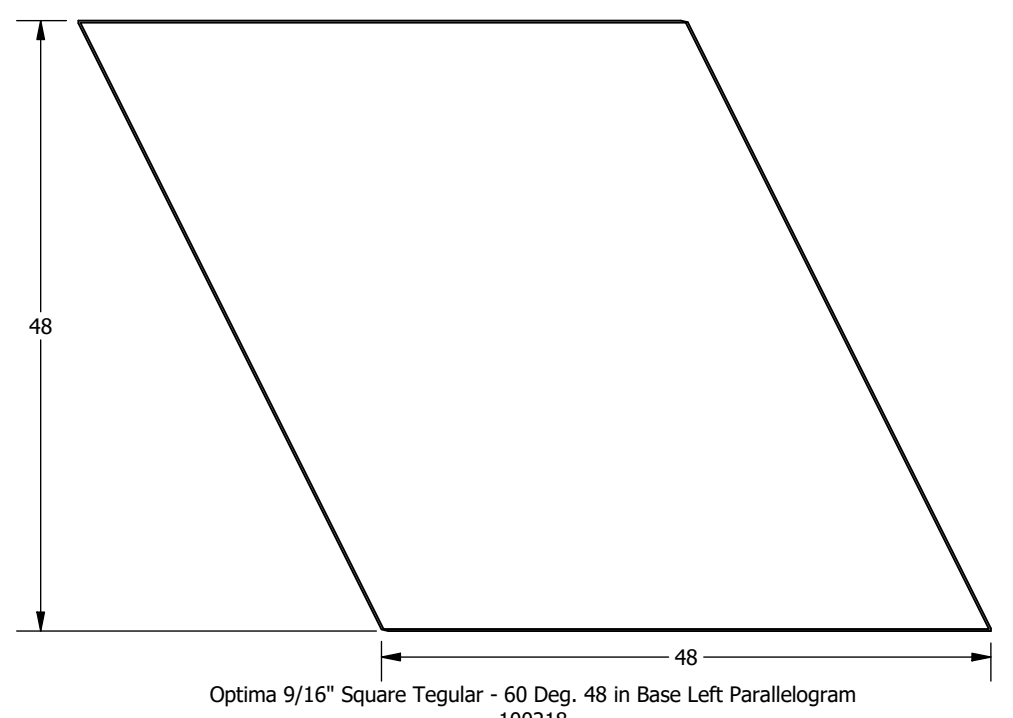
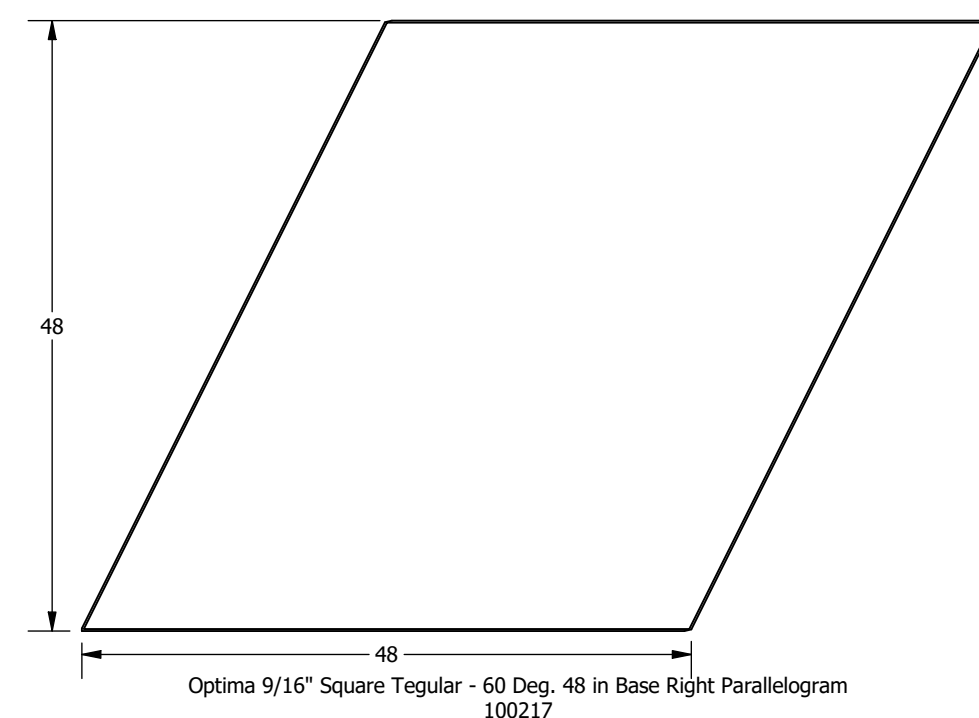
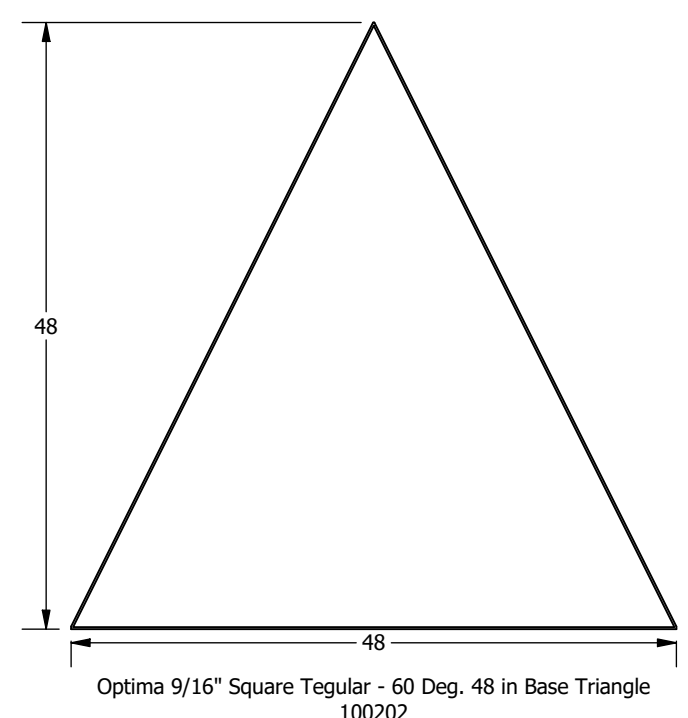
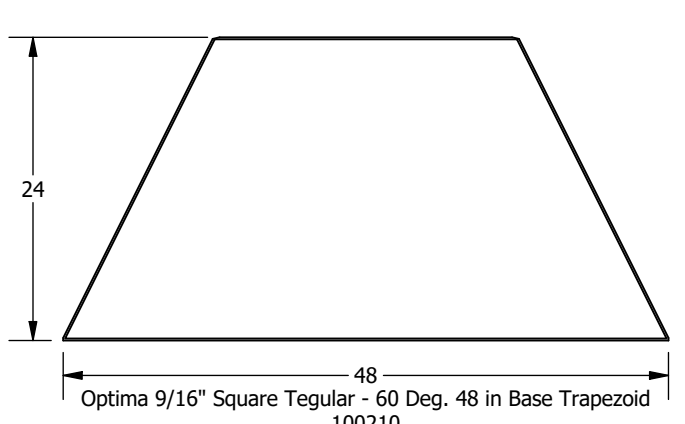
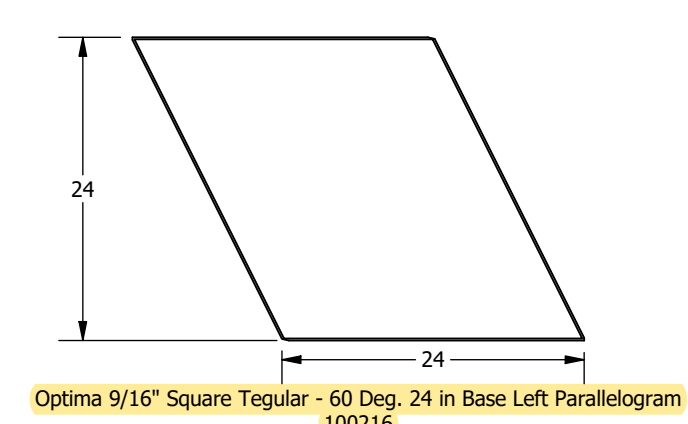
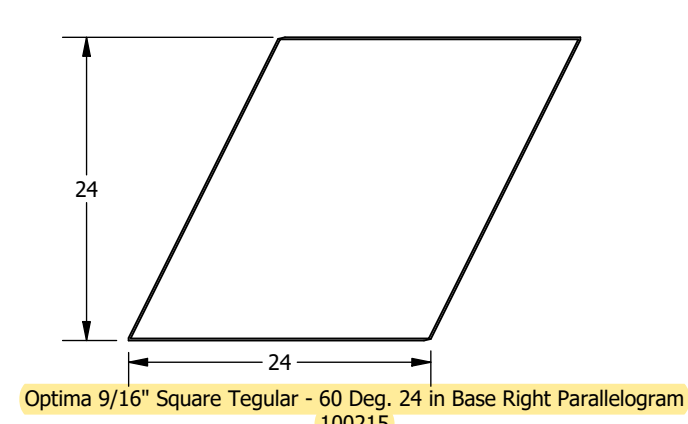
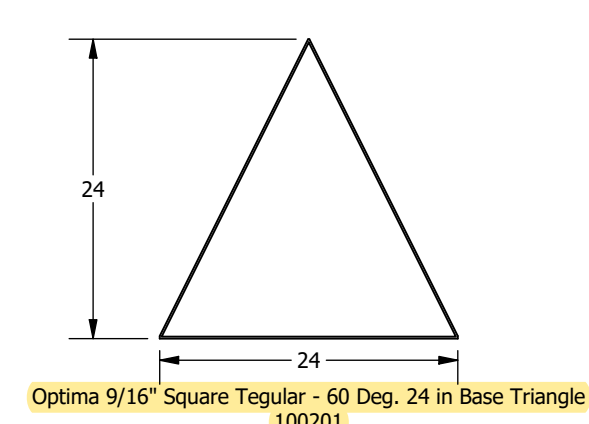
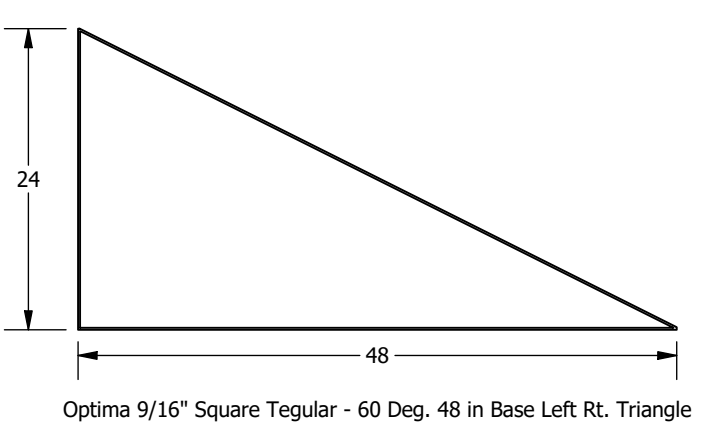
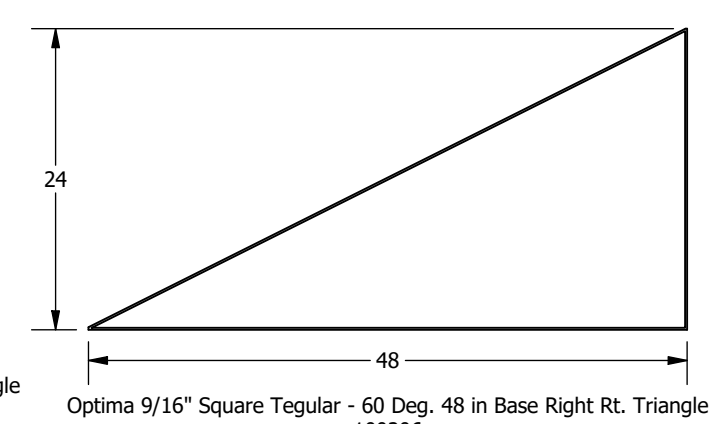
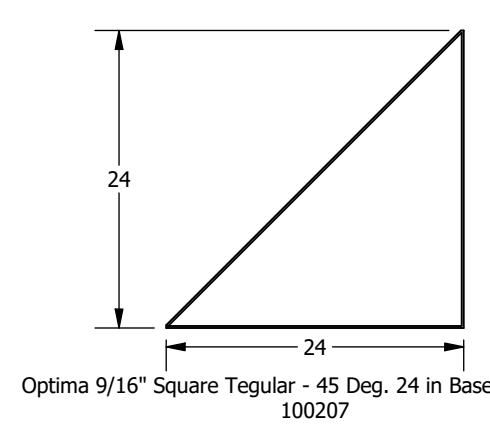
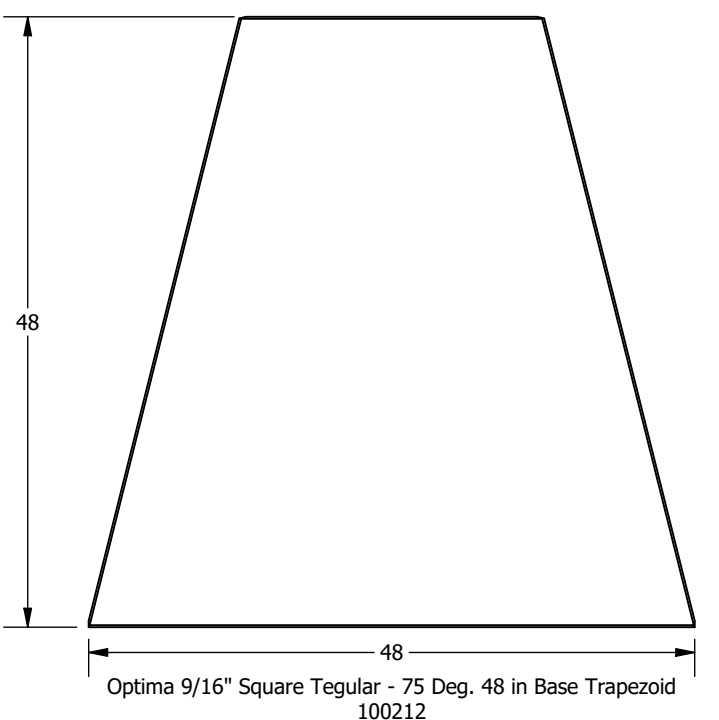
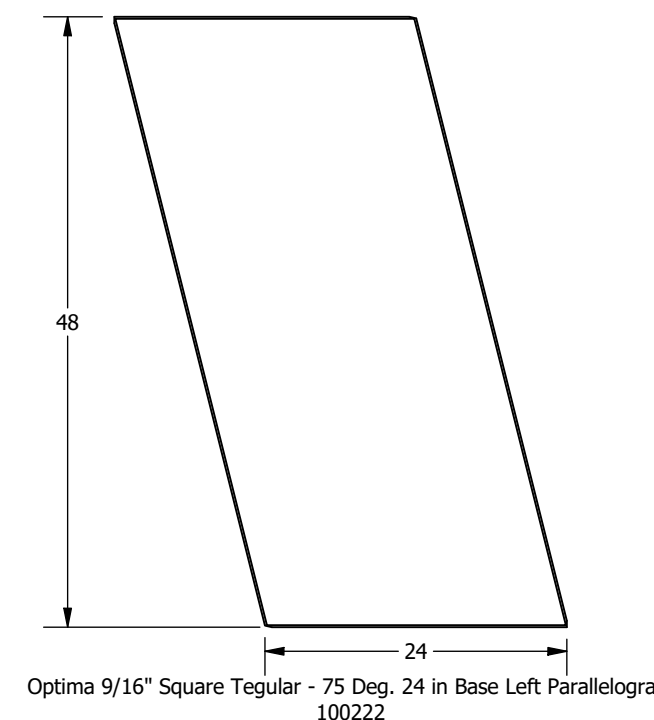
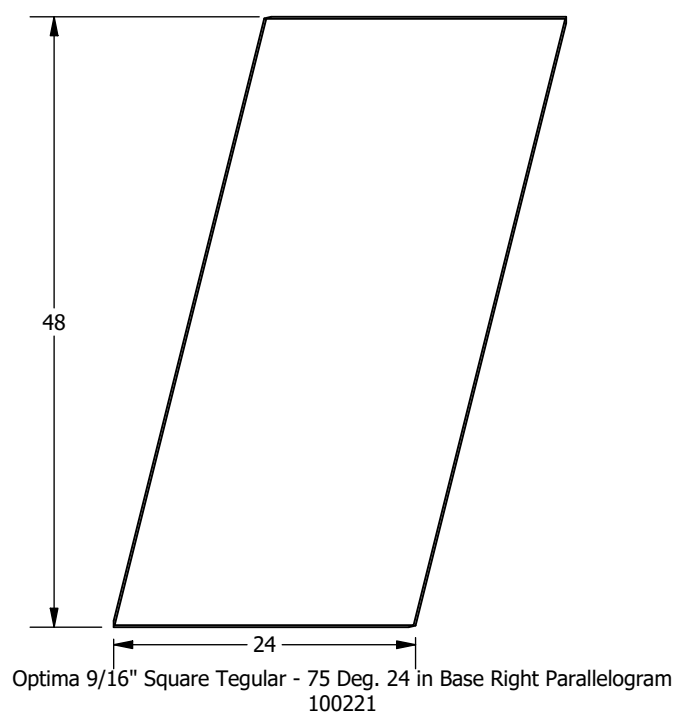
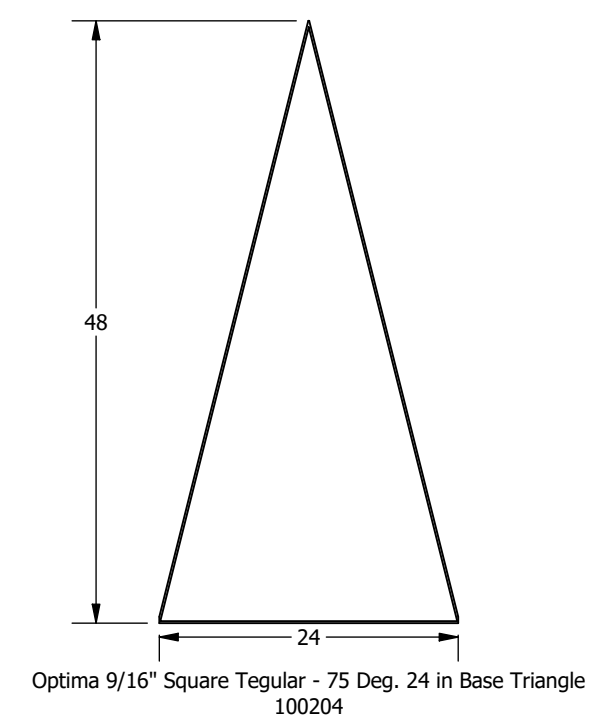
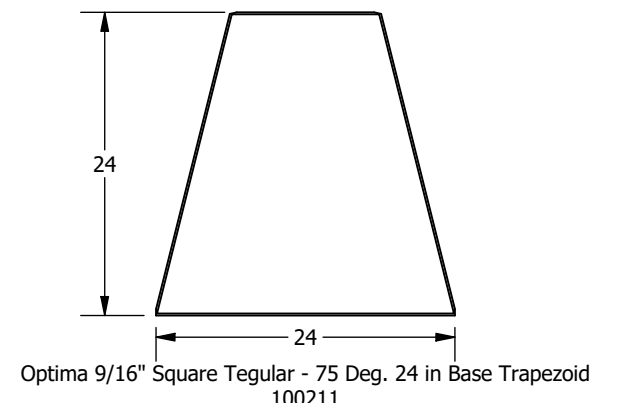
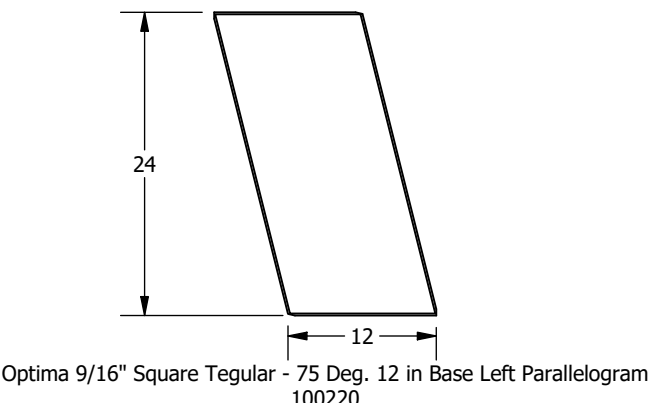
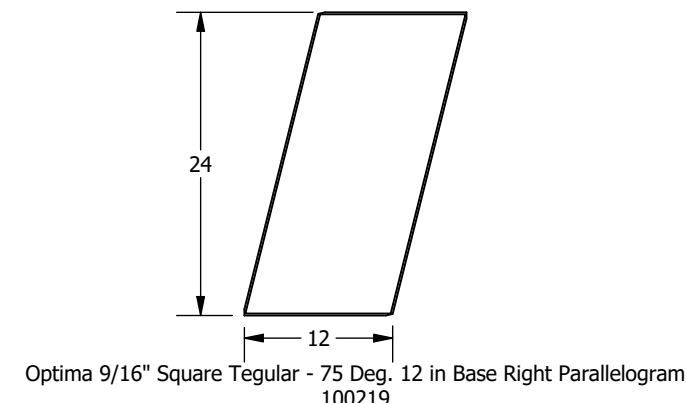
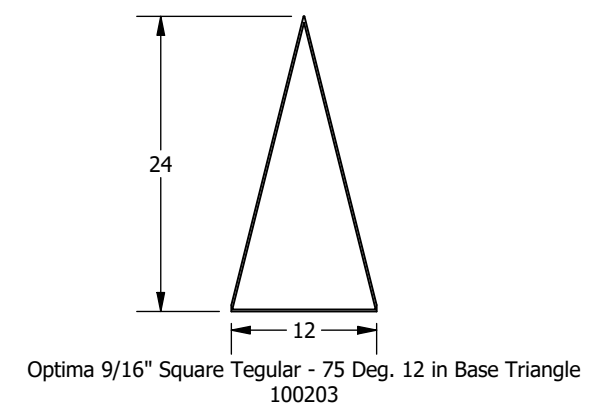

NOTES:  
1. Views are from the face of the panel, and descriptions are based on these views  
2. Dimensions are nominal and reflect grid spacings  
3. Scale 1:15

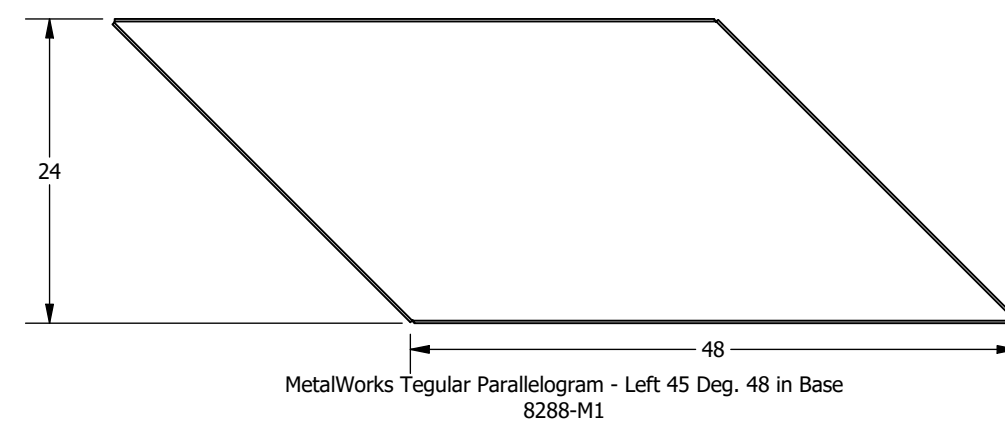
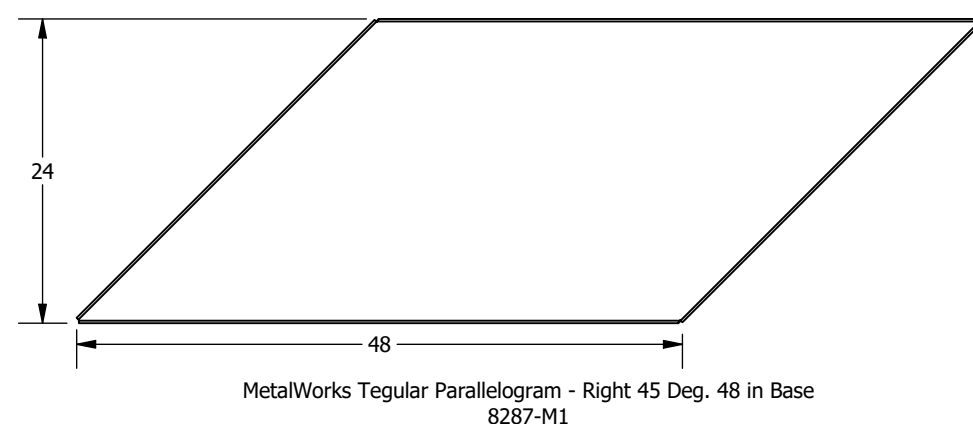
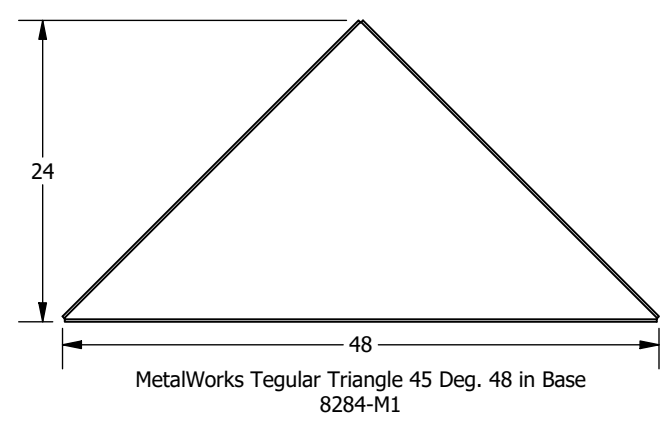
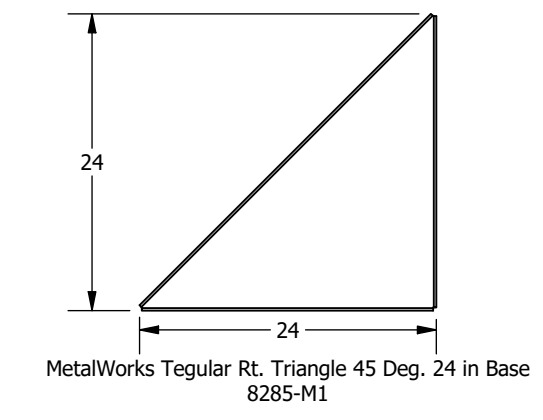
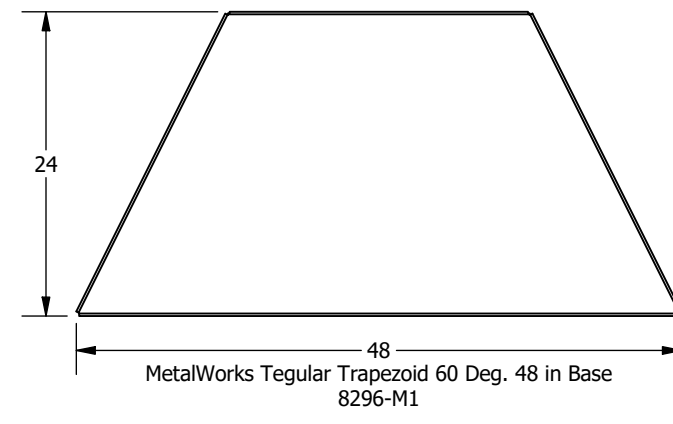
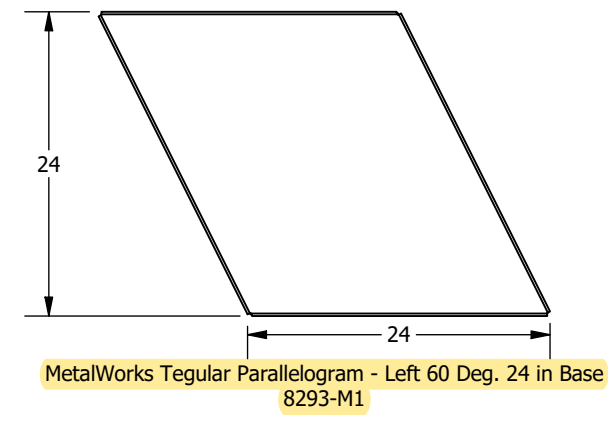
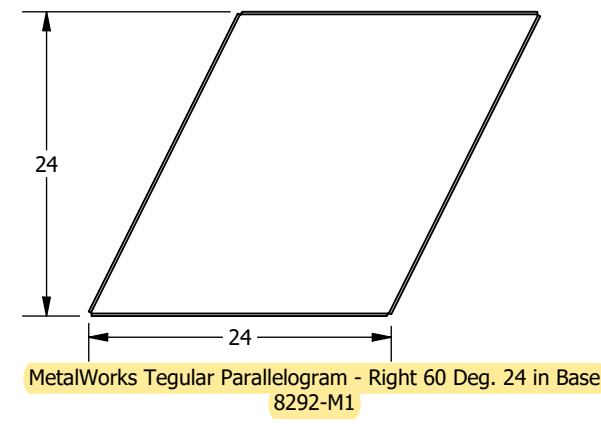
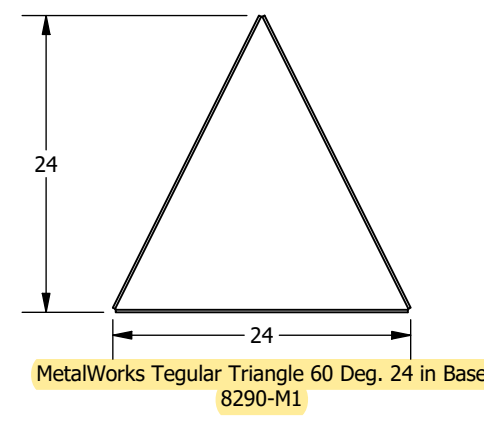

NOTES:  
 1. Views are from the face of the panel, and descriptions are based on these views  
 2. Dimensions are nominal and reflect grid spacings  
 3. Scale 1:15

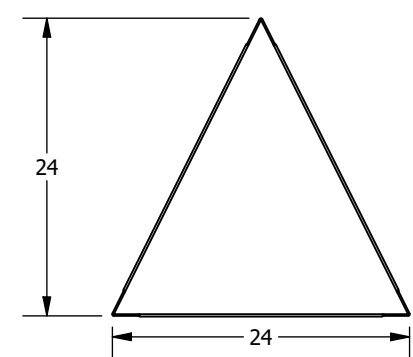

WoodWorks Tegular - 60 Deg. 24 in. Base Triangle  
8277-W1

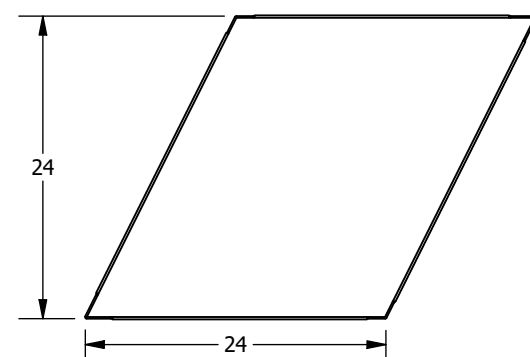

WoodWorks Tegular - 60 Deg. 24 in. Base Right Parallelogram  
8279-W1

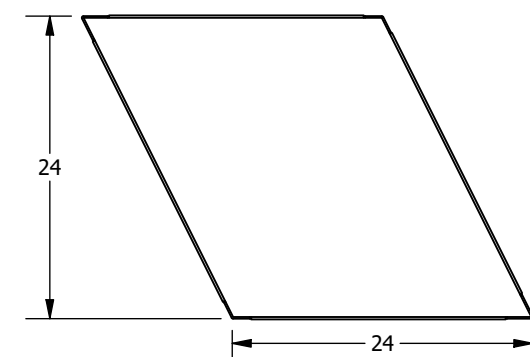

WoodWorks Tegular - 60 Deg. 24 in. Base Left Parallelogram  
8280-W1

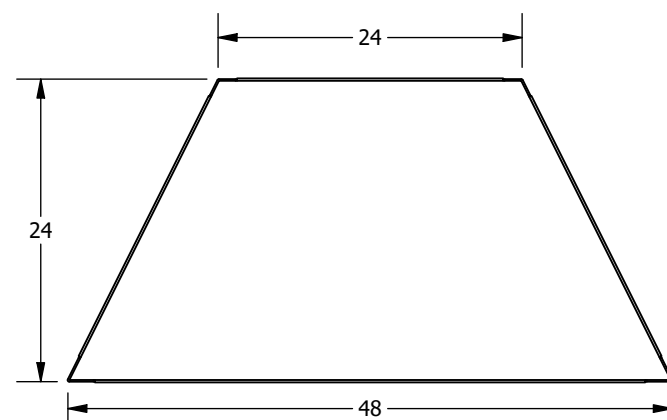

WoodWorks Tegular - 60 Deg. 48 in. Base Trapezoid  
8281-W1

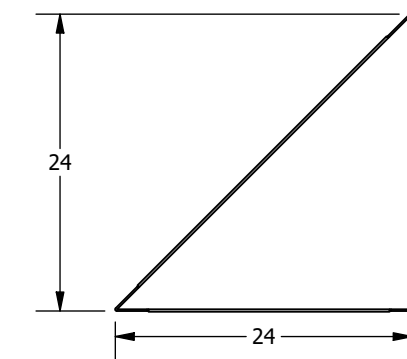

WoodWorks Tegular - 45 Deg. 24 in. Base Right Rt. Triangle  
8272-W1

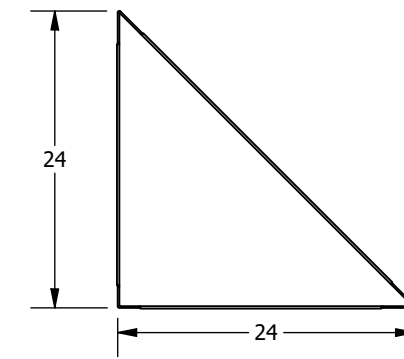

WoodWorks Tegular - 45 Deg. 24 in. Base Left Rt. Triangle  
8282-W1

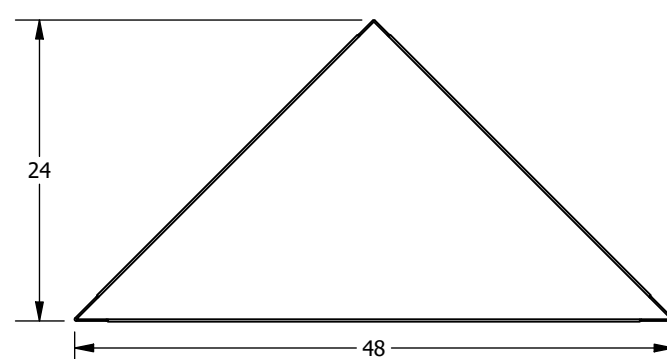

WoodWorks Tegular - 45 Deg. 48 in. Base Triangle  
8271-W1

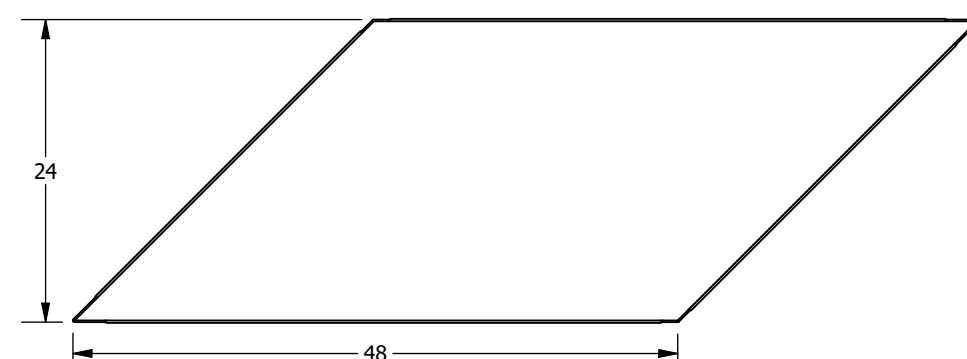

WoodWorks Tegular - 45 Deg. 48 in. Base Right Parallelogram  
8274-W1

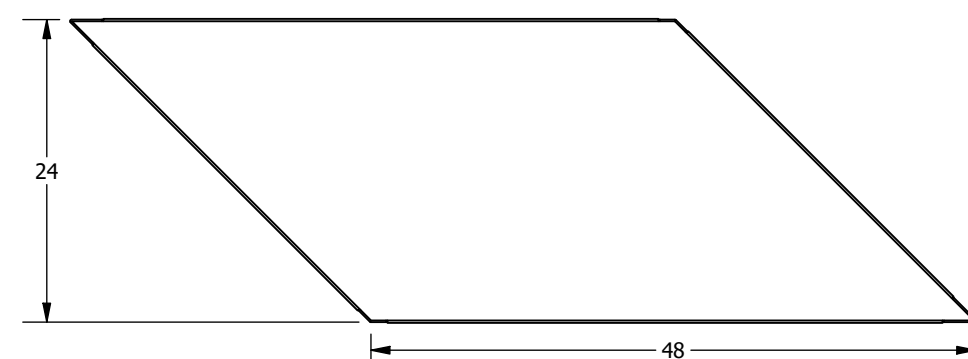

WoodWorks Tegular - 45 Deg. 48 in. Base Left Parallelogram  
8275-W1

NOTES:  
1. Views are from the face of the panel, and descriptions are based on these views  
2. Dimensions are nominal and reflect grid spacings  
3. Scale 1:15