

FLAT DETAILS

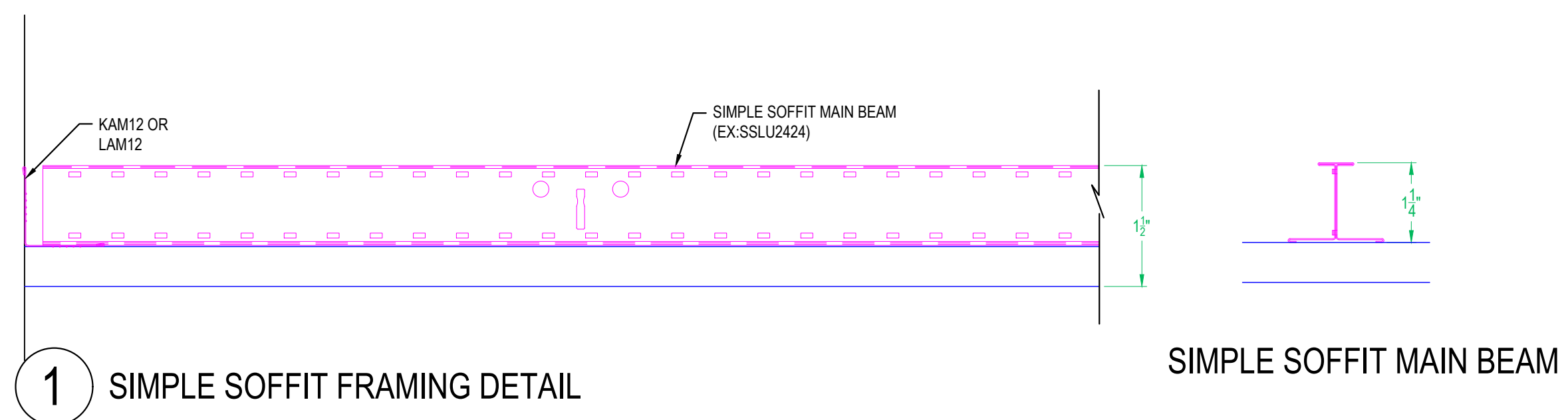

WALL ANGLE DETAILS

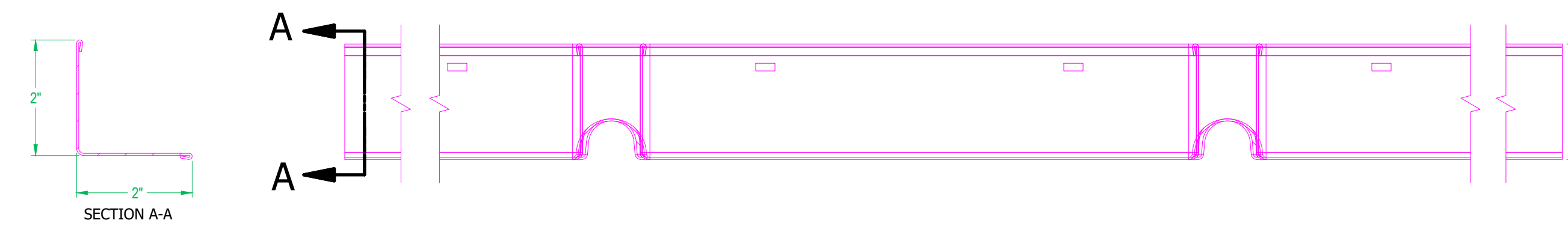
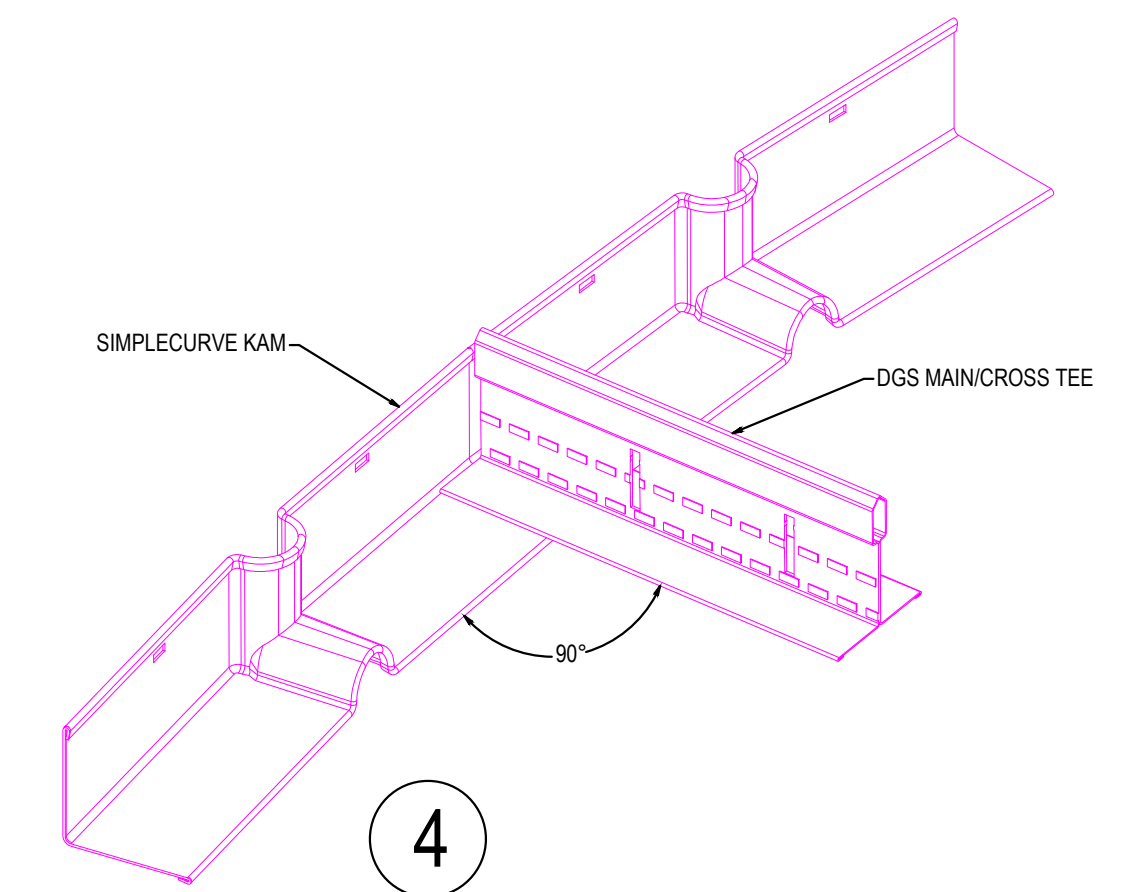
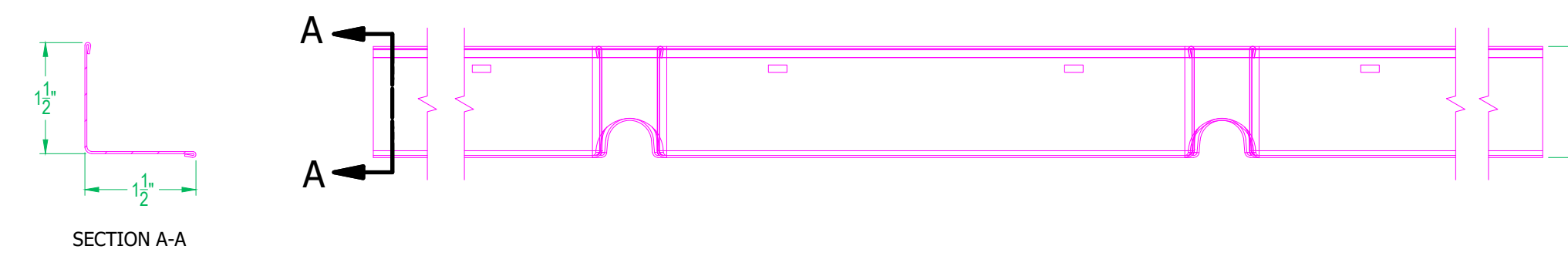
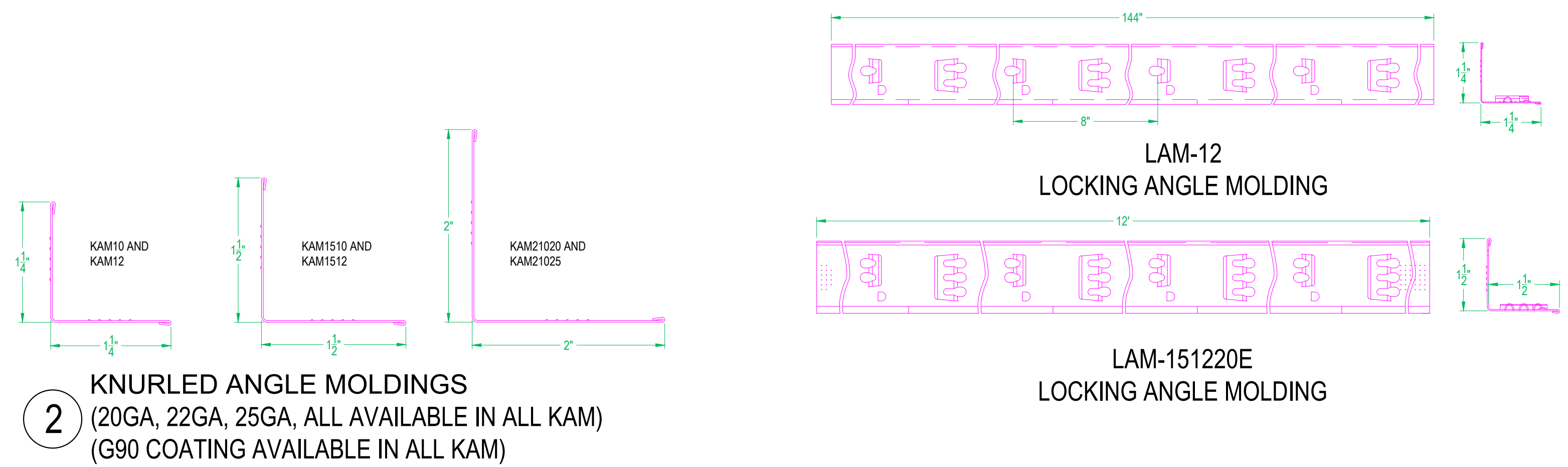

<small>These drawings show typical conditions in which the Armstrong® product depicted is installed. They are not a substitute for an architect's or engineer's plan and do not reflect the unique requirements of local building codes, laws, statutes, ordinances, rules and regulations (Legal Requirements) that may be applicable for a particular installation.</small> <small>Armstrong Ceiling Solutions does not warrant, and assumes no liability for the accuracy or completeness of the drawings for a particular installation or their fitness for a particular purpose. The user is advised to consult with a duly licensed architect or engineer in the particular locale of the installation to assure compliance with all Legal Requirements. Armstrong is not licensed to provide professional architecture or engineering design services.</small>		PROJECT NAME: SIMPLE SOFFIT MASTER SHEET	
DWG. NO. SHEET 1	SCALE: .	REV: .	DATE: .
DATE: 11/10/22	DRAWN BY: MAP	CHK BY: .	DESC: .
TechLine		ARMSTRONG CEILING & WALL SOLUTIONS • Lancaster, PA • Phone: 877-ARMSTRONG	

SIMPLE SOFFIT DETAILS

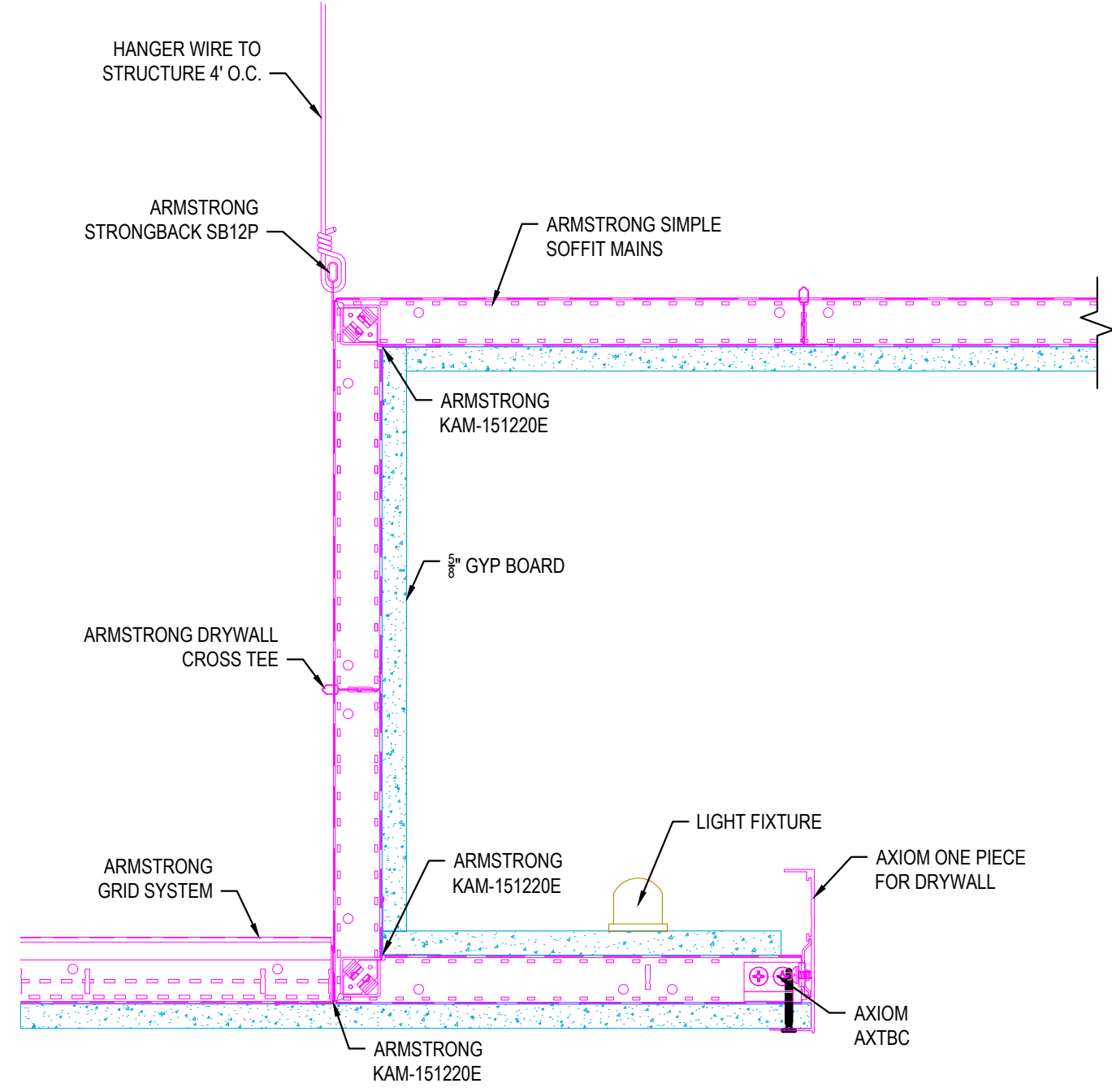

6 SIMPLE SOFFIT LIGHT COVE WITH AXIOM ONE PIECE

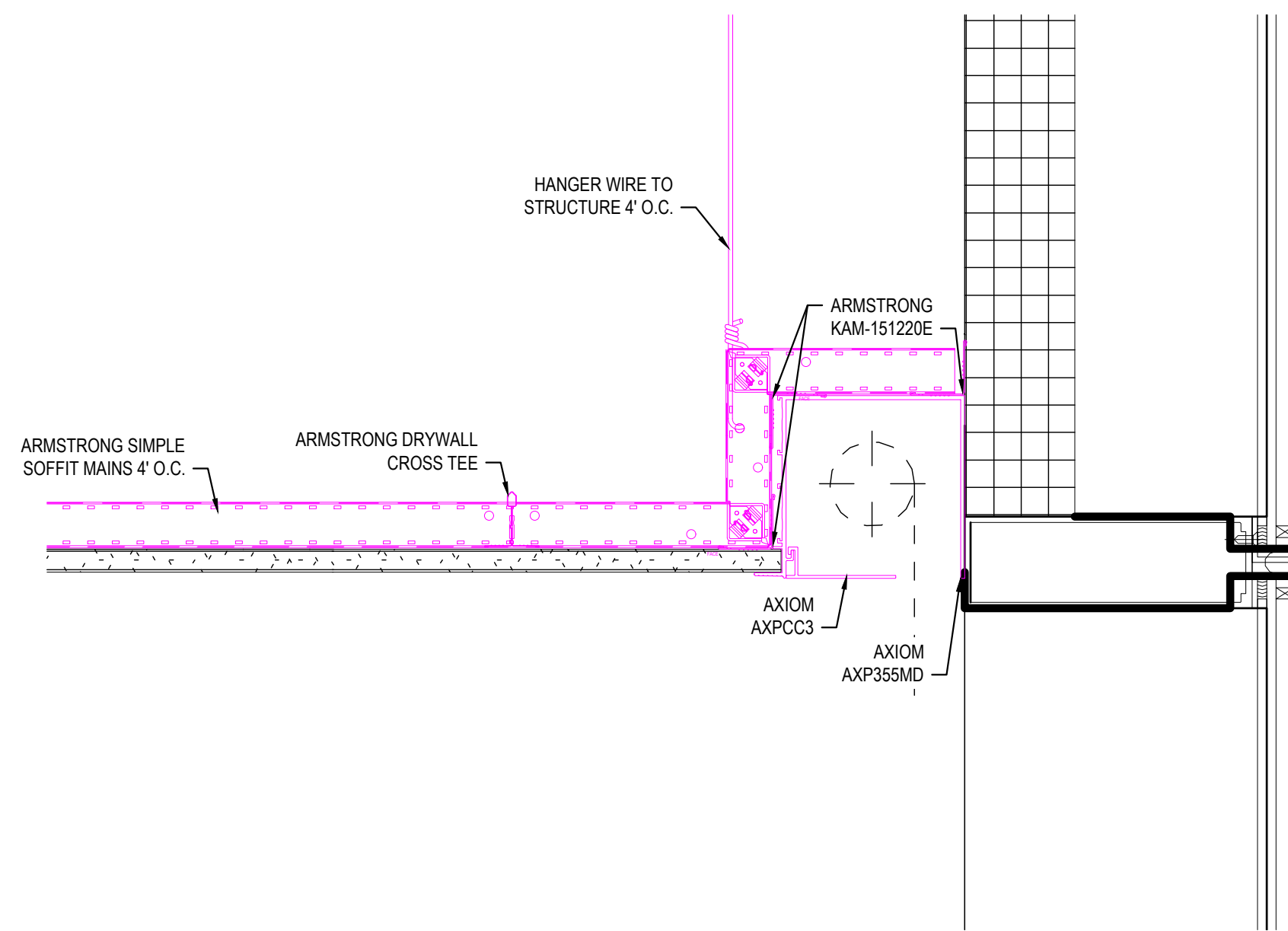

7 SIMPLE SOFFIT SOFFIT AROUND AXIOM BUILDING PERIMETER POCKET

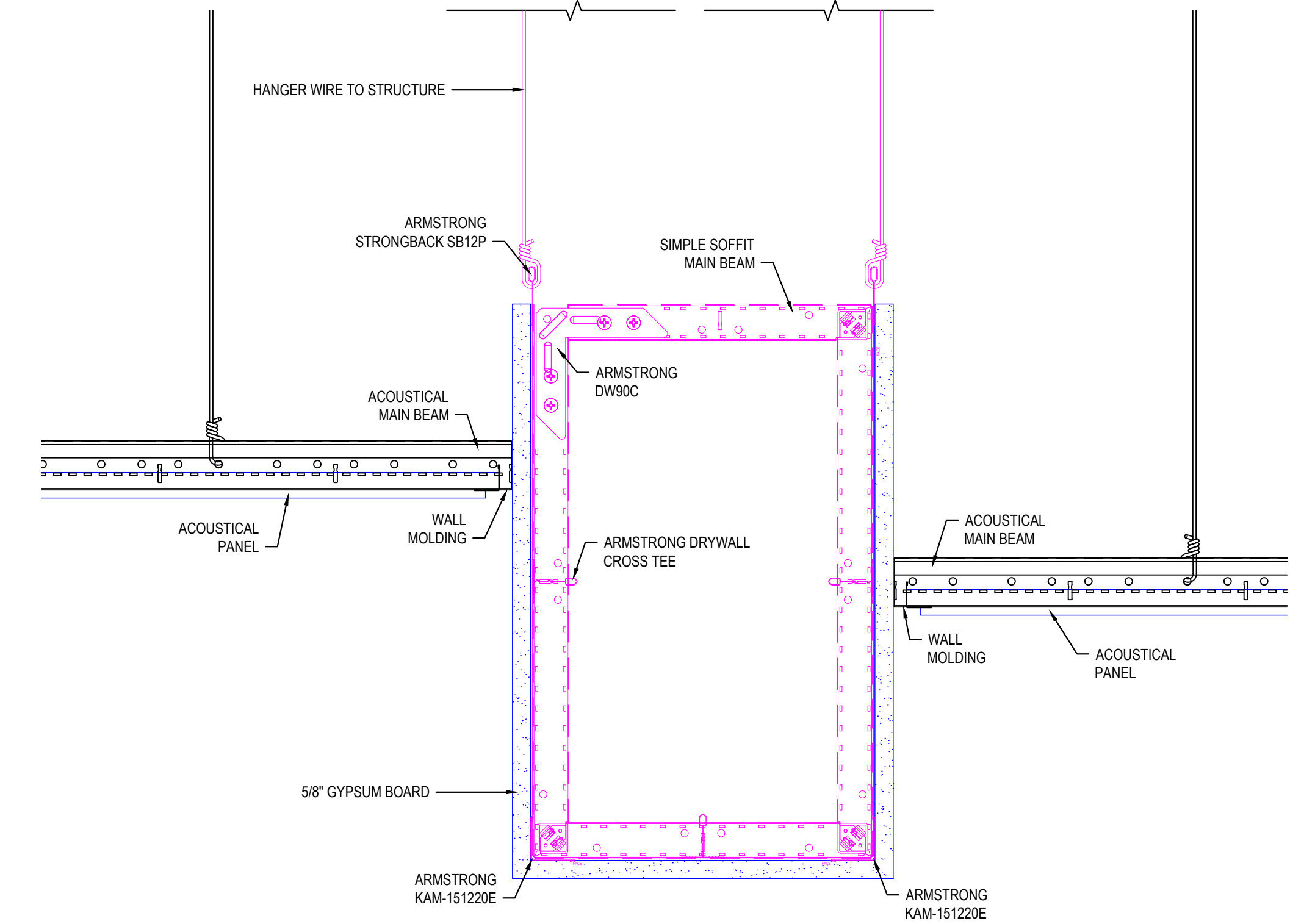

8 SIMPLE SOFFIT SOFFIT BULKHEAD

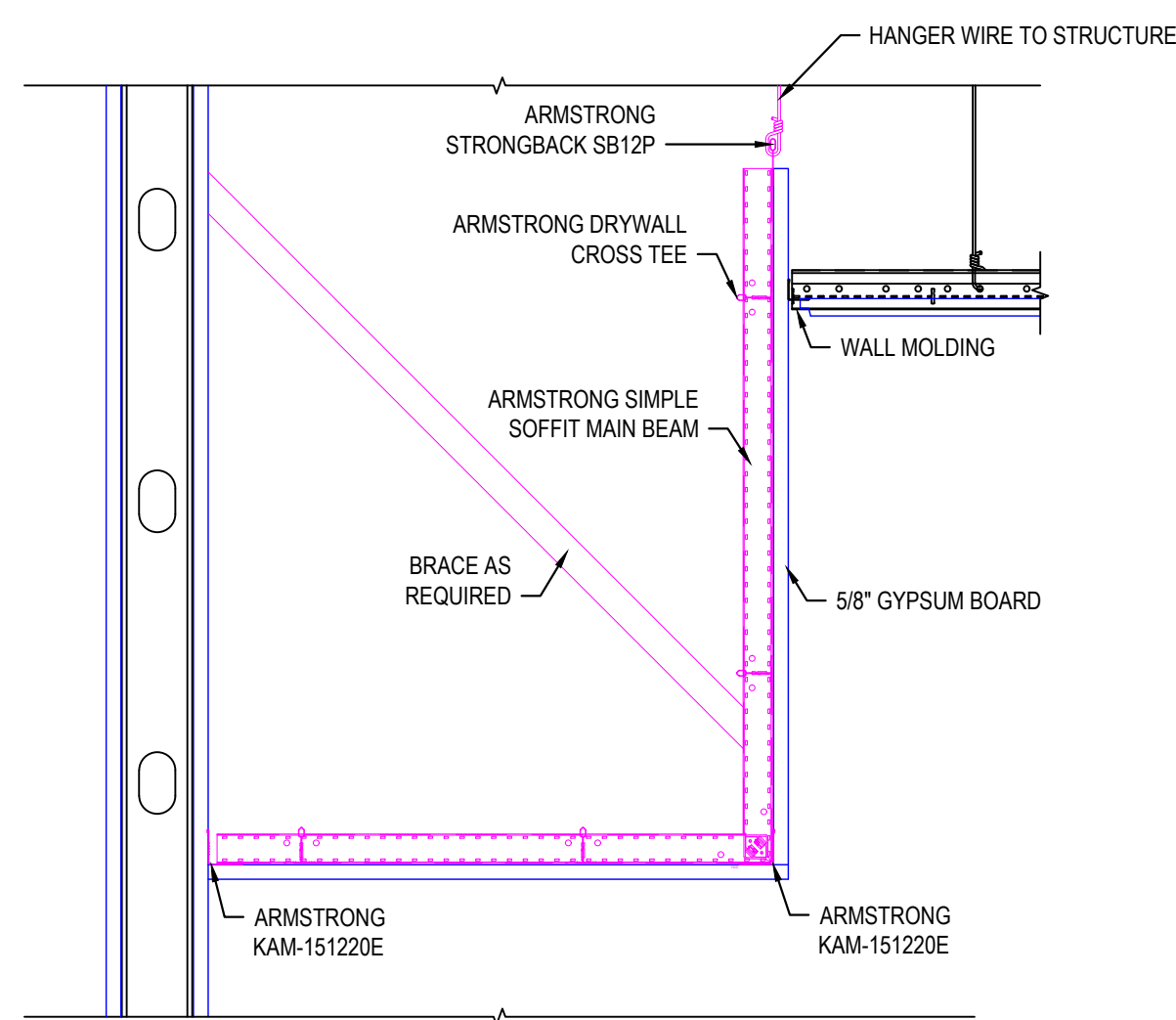

9 SIMPLE SOFFIT L SOFFIT

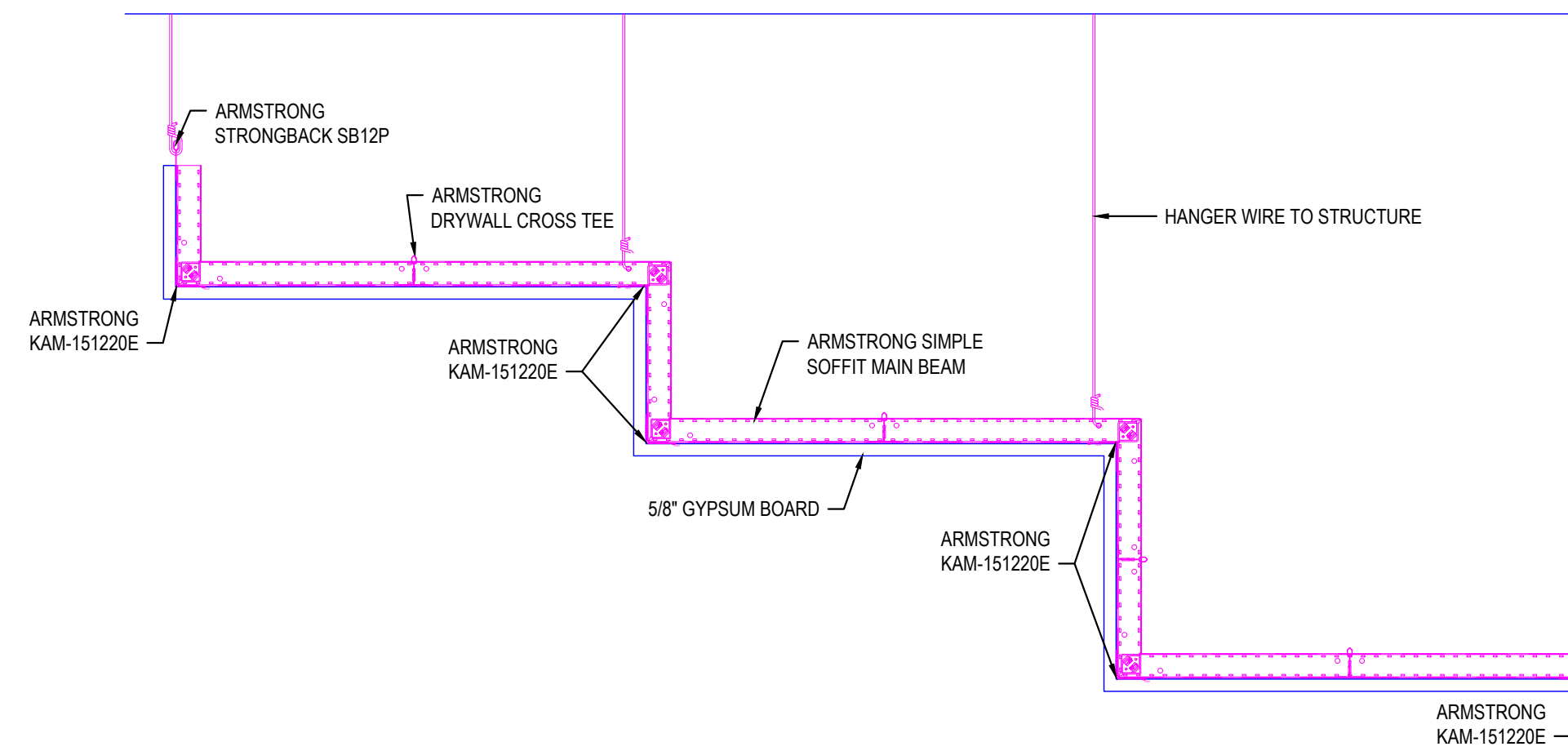

10 SIMPLE SOFFIT STEP SOFFIT

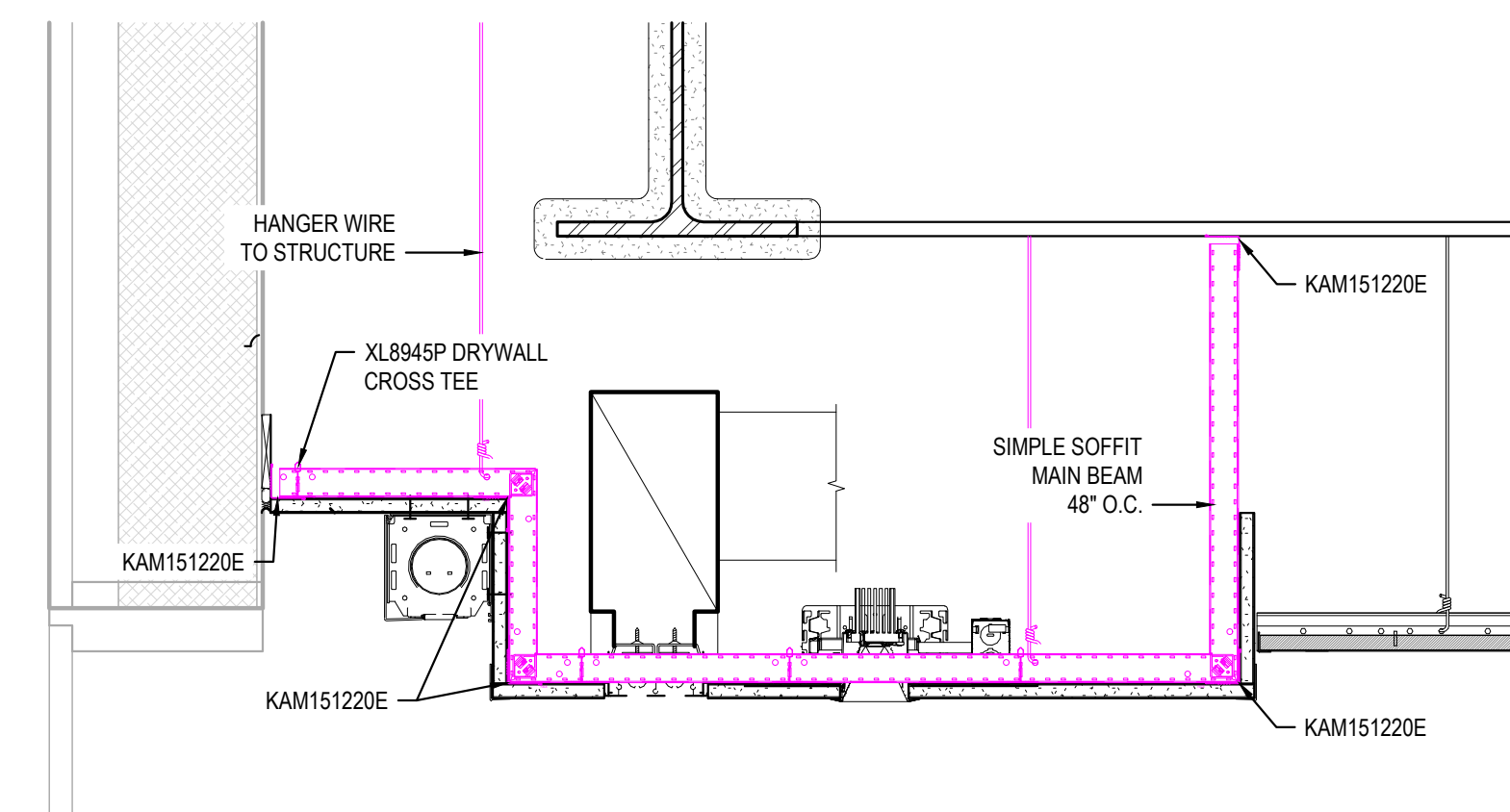

11 SIMPLE SOFFIT CUSTOM SOFFIT

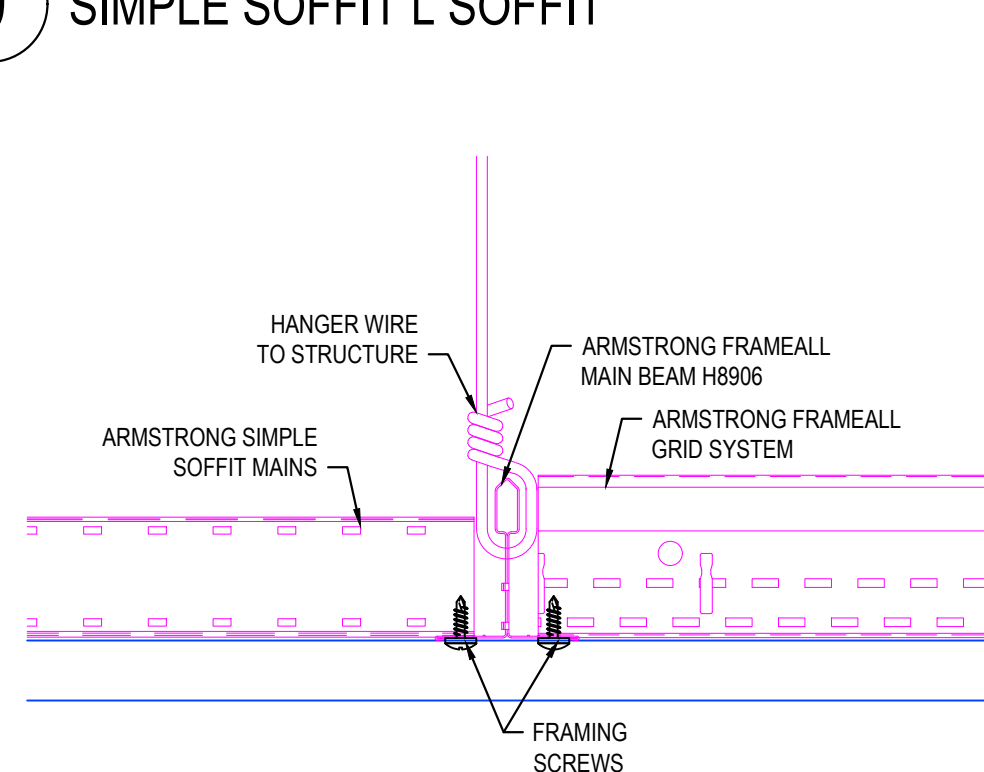

12 SIMPLE SOFFIT FLUSH TRANSITION TO FRAMEALL DRYWALL GRID

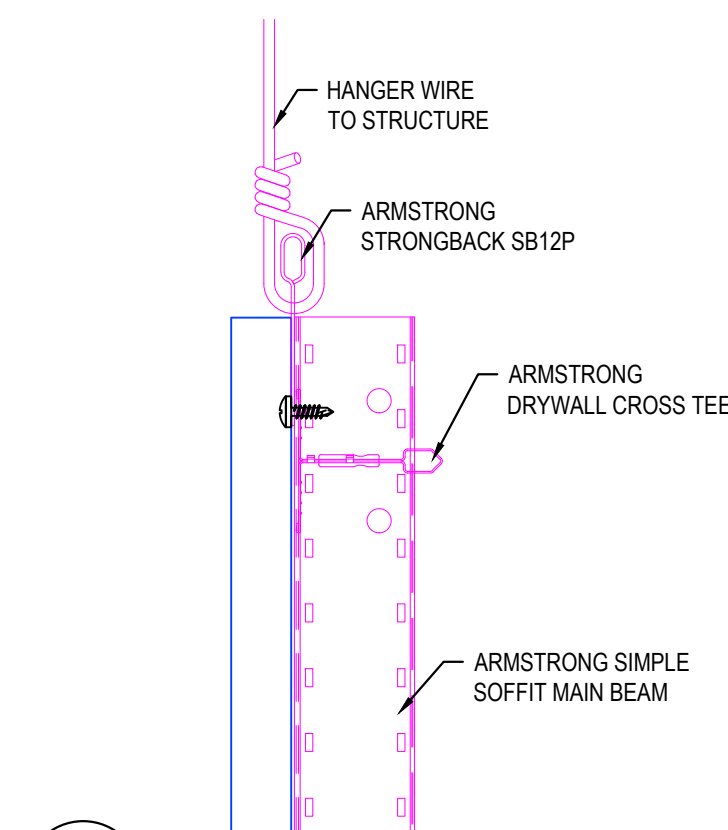

13 SIMPLE SOFFIT WITH STRONGBACK SUPPORT

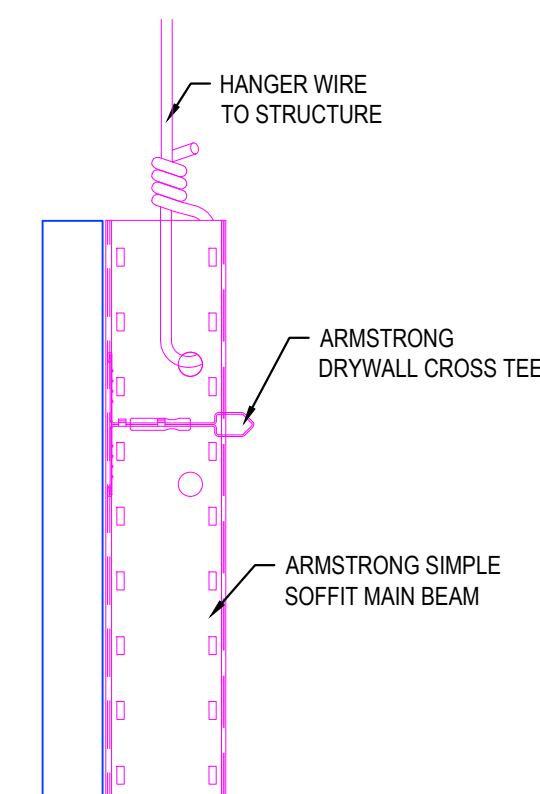

14 SIMPLE SOFFIT WITH HANGER WIRE

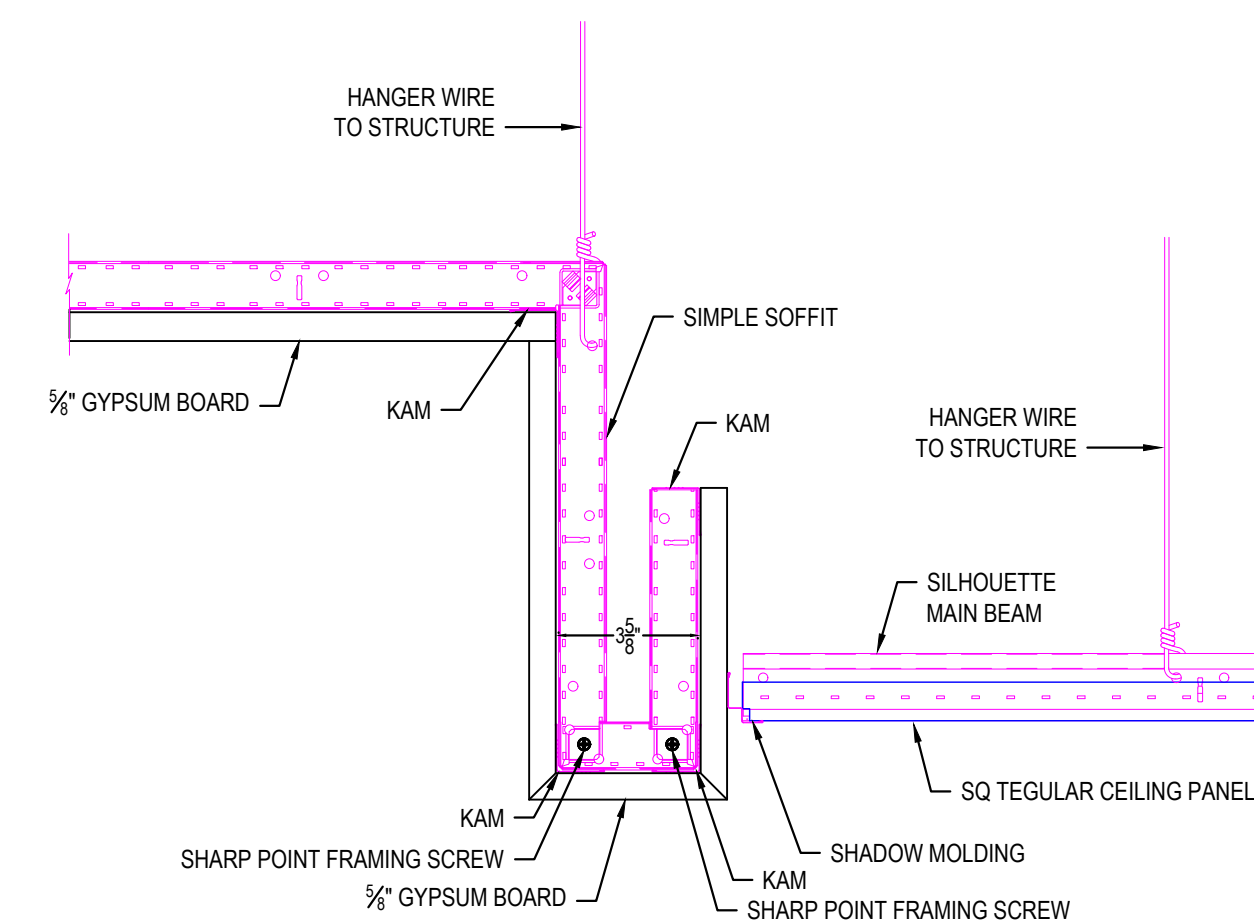

15 SIMPLE SOFFIT 3-5/8" BULKHEAD

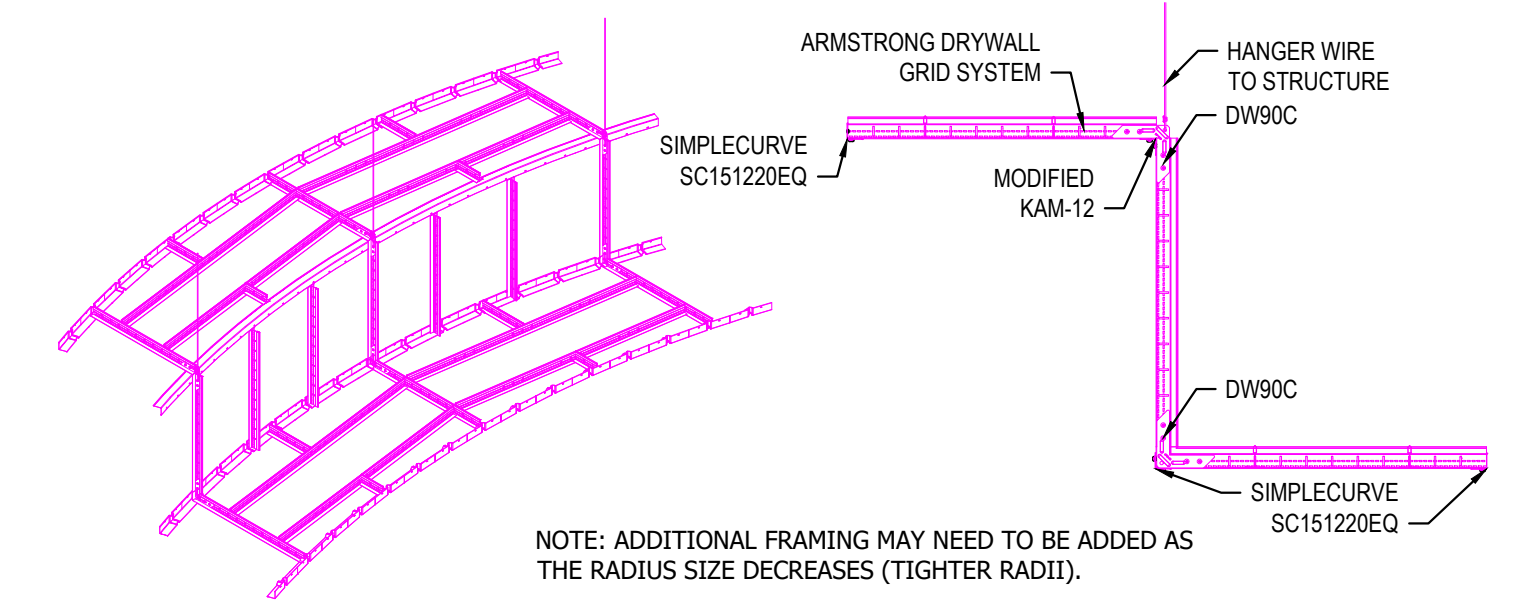

16 DRYWALL STEP SOFFIT SOFFIT WITH SIMPLECURVE

<small>These drawings show typical conditions in which the Armstrong® product depicted is installed. They are not a substitute for an architect's or engineer's plan and do not reflect the unique requirements of local building codes, laws, ordinances, rules and regulations (Legal Requirements) that may be applicable for a particular installation.</small> <small>Armstrong Ceiling Solutions does not warrant, and assumes no liability for the accuracy or completeness of the drawings for a particular installation or their fitness for a particular purpose.</small> <small>The user is advised to consult with a duly licensed architect or engineer in the particular locale of the installation to assure compliance with all legal requirements.</small> <small>Armstrong is not licensed to provide professional architecture or engineering design services.</small>		PROJECT NAME: SIMPLE SOFFIT MASTER SHEET	
DWG. NO. SHEET 2 DATE: 8/7/23 DRAWN BY: MAP	SCALE: CHK BY:	REV.: DESC.:	DATE:
TechLine <small>ARMSTRONG CEILING & WALL SOLUTIONS • Lancaster, PA • Phone: 877-ARMSTRONG</small>			

SIMPLE SOFFIT STANDARD OPTIONS

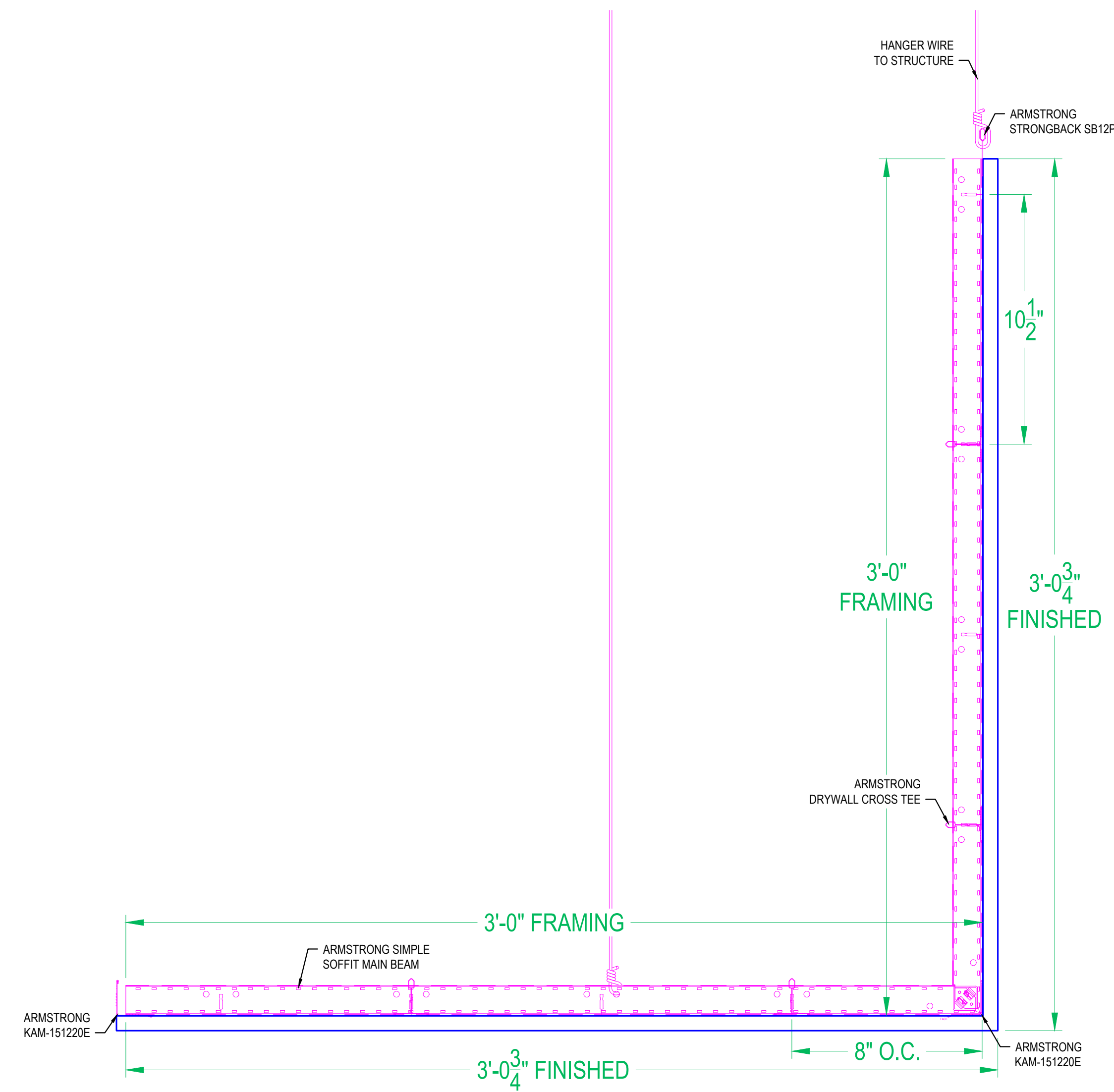

15 SIMPLE SOFFIT SSLU3636

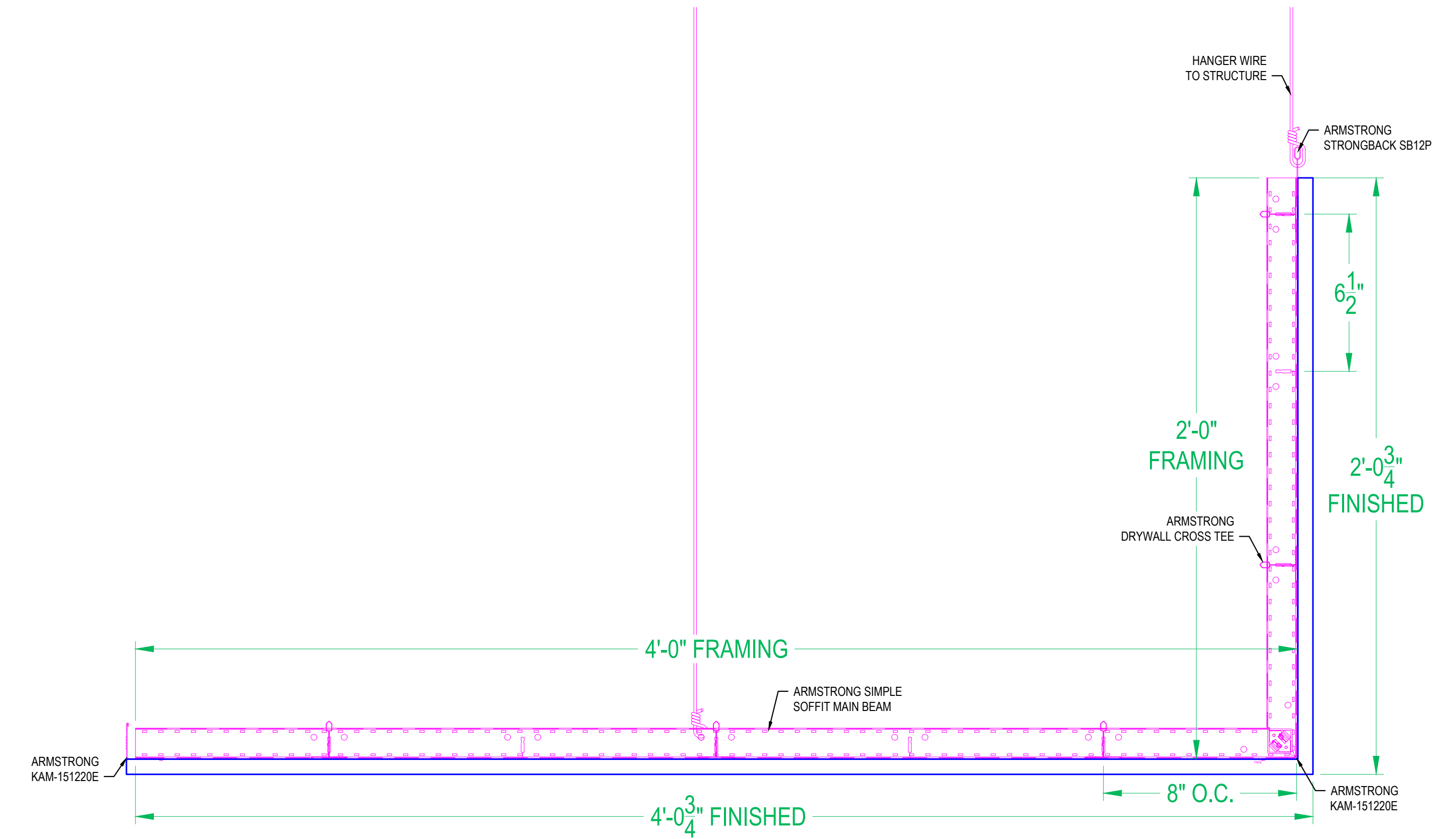

16 SIMPLE SOFFIT SSLU4824

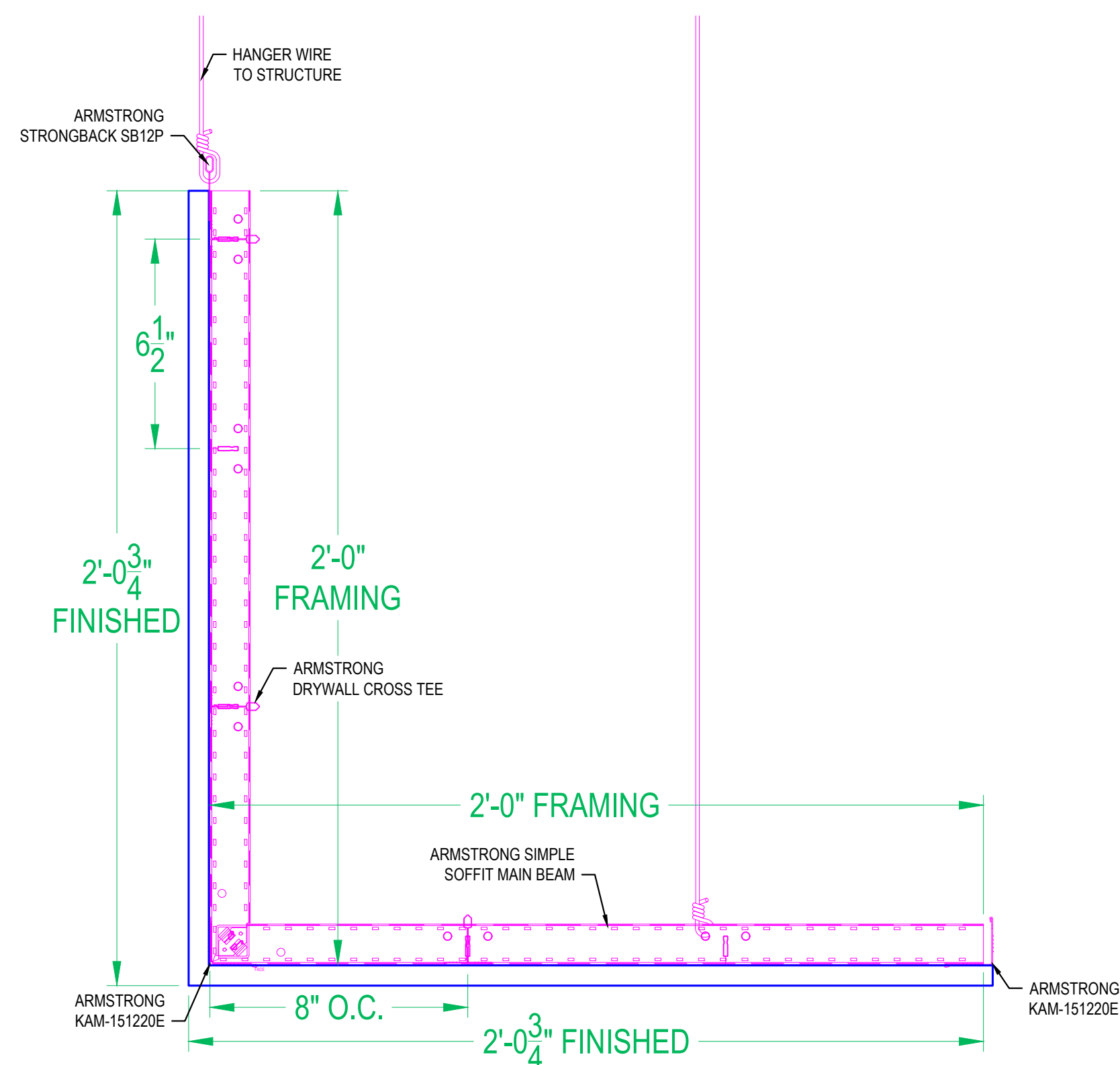

17 SIMPLE SOFFIT SSLU2424

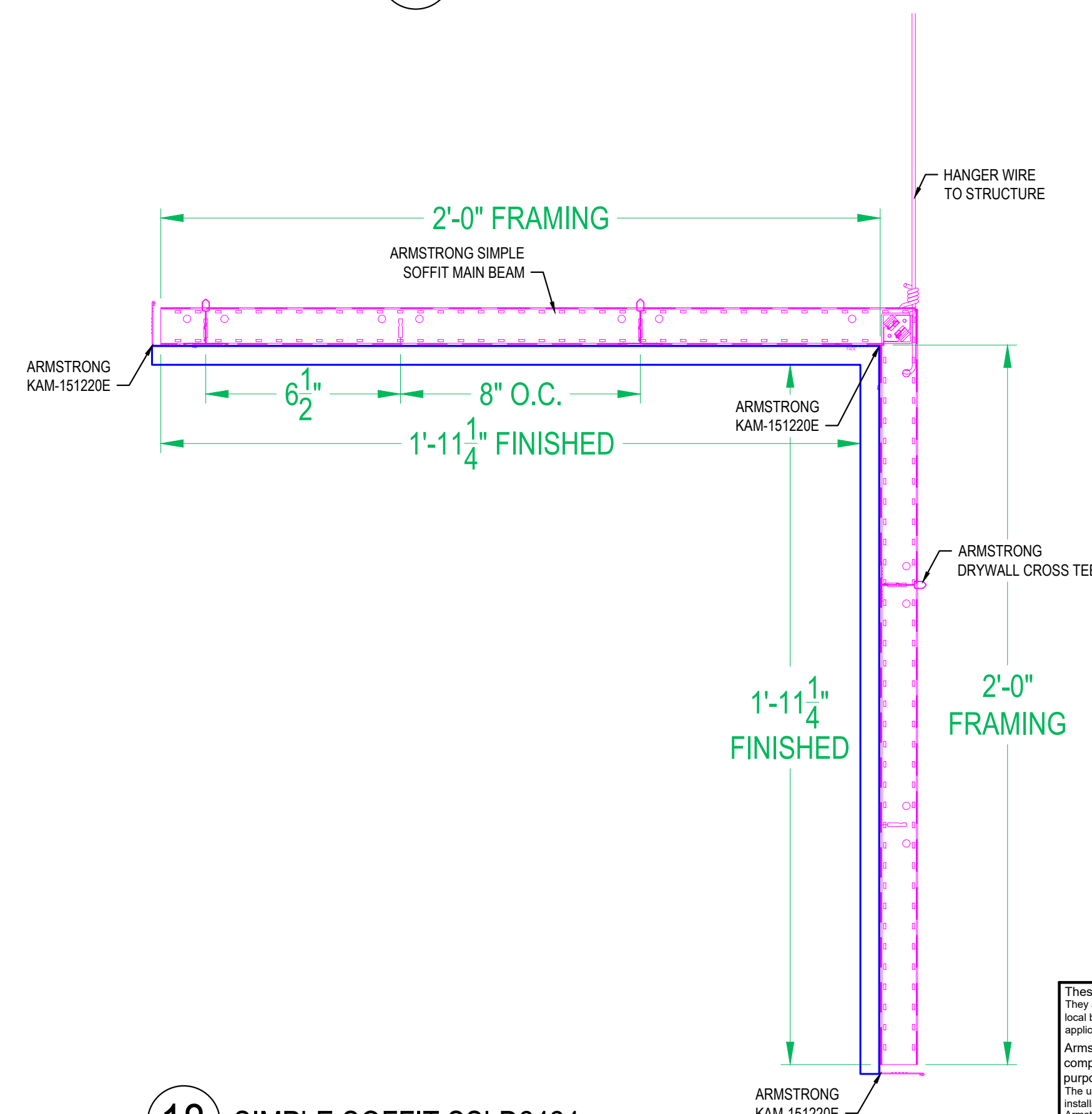

18 SIMPLE SOFFIT SSLD2424

These drawings show typical conditions in which the Armstrong® product depicted is installed. They are not a substitute for an architect's or engineer's plan and do not reflect the unique requirements of local building codes, laws, statutes, ordinances, rules and regulations (Legal Requirements) that may be applicable for a particular installation.

Armstrong Ceiling Solutions does not warrant, and assumes no liability for the accuracy or completeness of the drawings for a particular installation or their fitness for a particular purpose. The user is advised to consult with a duly licensed architect or engineer in the particular locale of the installation to assure compliance with all legal requirements. Armstrong is not licensed to provide professional architecture or engineering design services.

PROJECT NAME: SIMPLE SOFFIT MASTER SHEET		REV: .	DATE: .
DWG. NO. SHEET 3	SCALE: .		
DATE: 8/7/23	DRAWN BY: MAP	CHK BY: .	

Techn ARMSTRONG CEILING & WALL SOLUTIONS • Lancaster, PA • Phone: 877-ARMSTRONG **Armstrong** CEILING & WALL SOLUTIONS

SIMPLE SOFFIT STANDARD OPTIONS

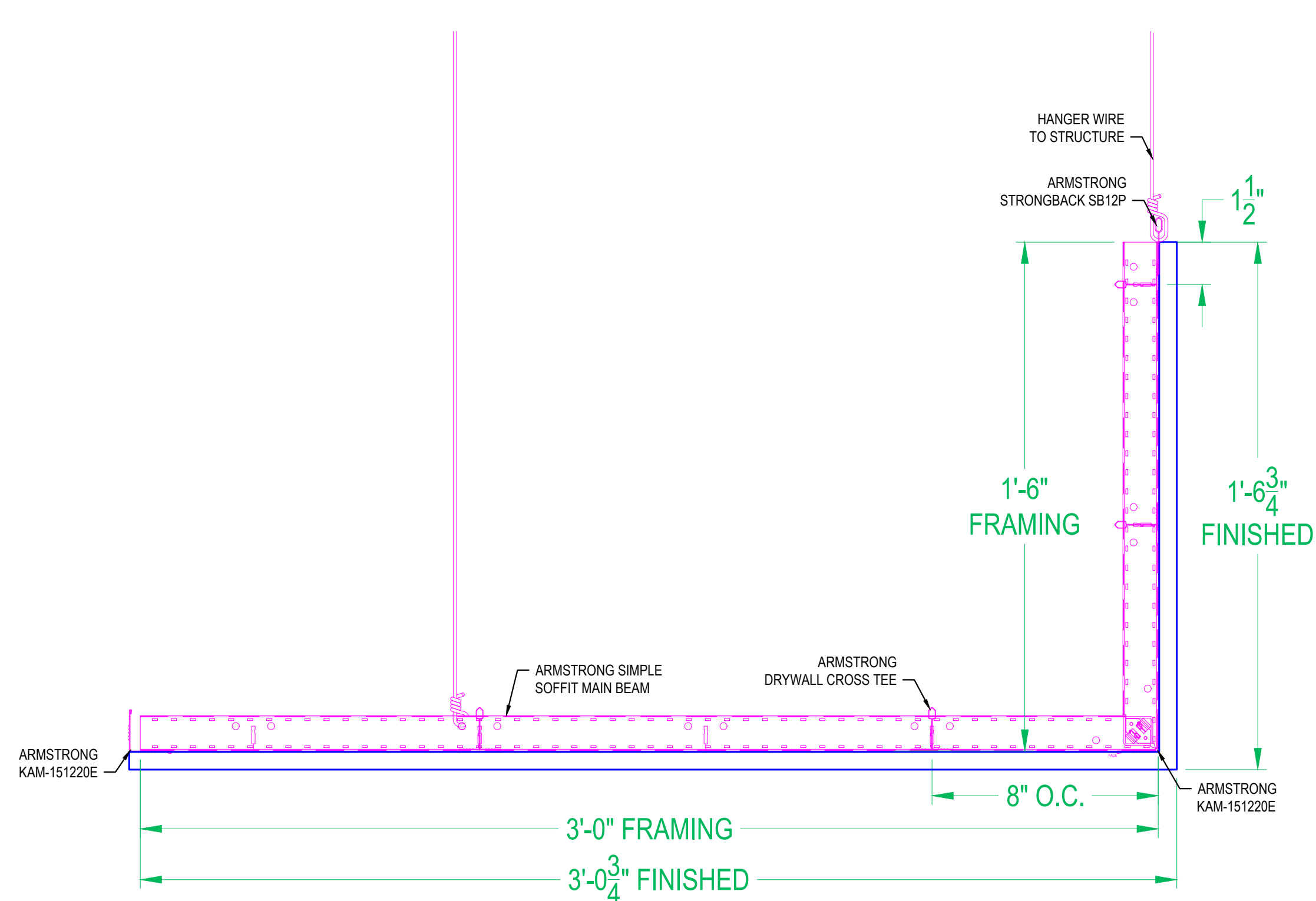

19 SIMPLE SOFFIT SSLU1836

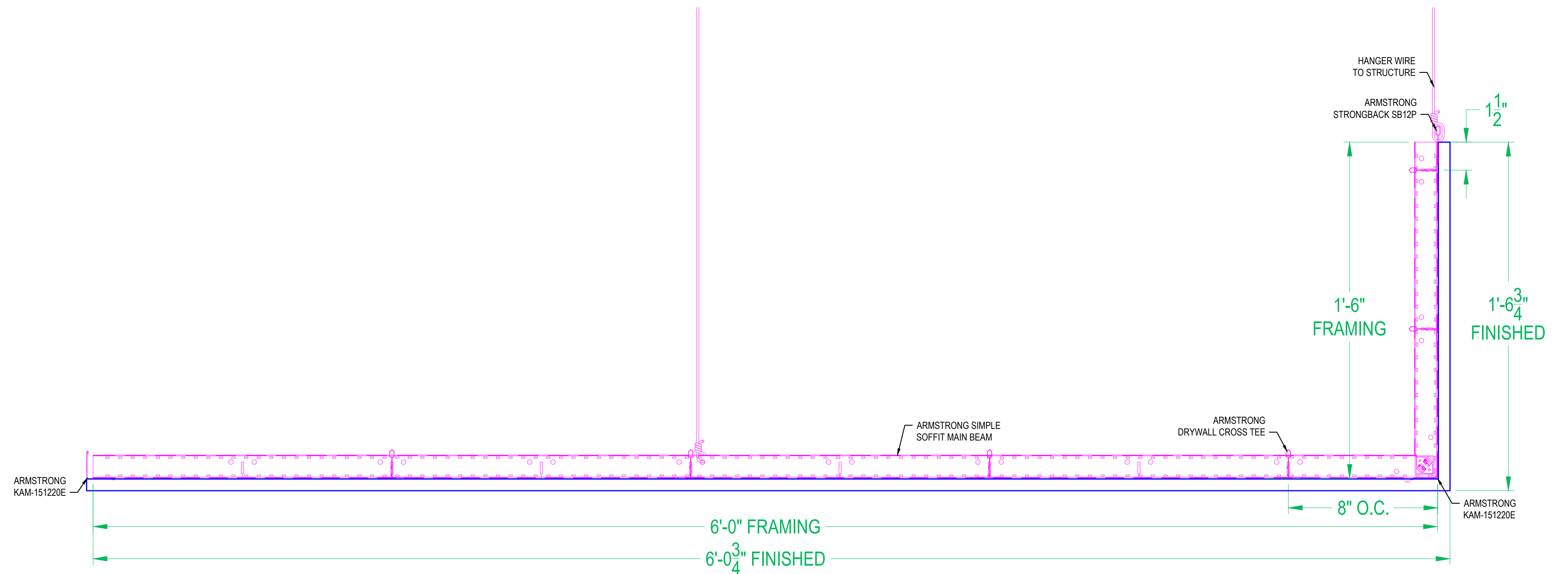

20 SIMPLE SOFFIT SSLU1872

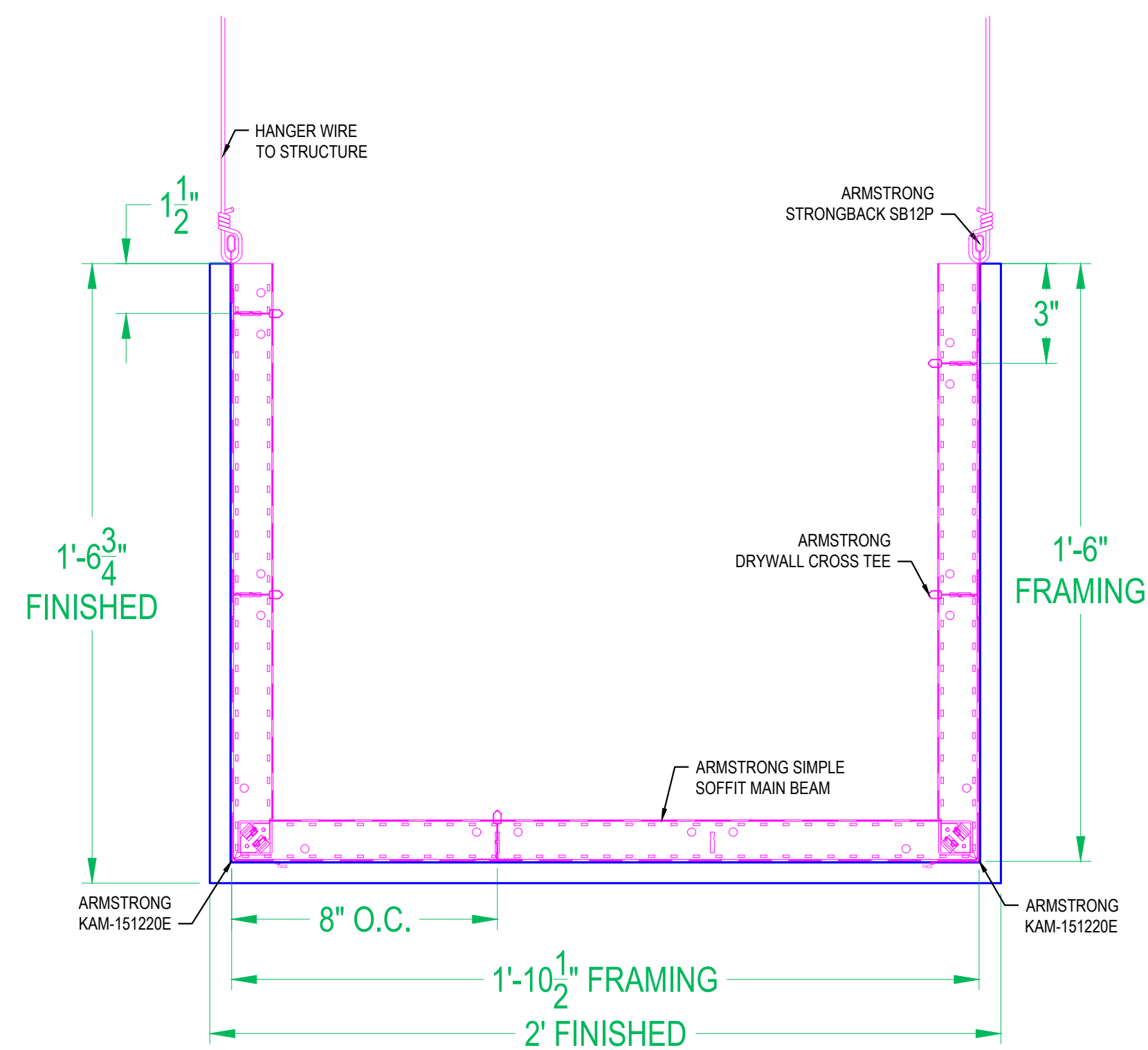

21 SIMPLE SOFFIT SSU182418

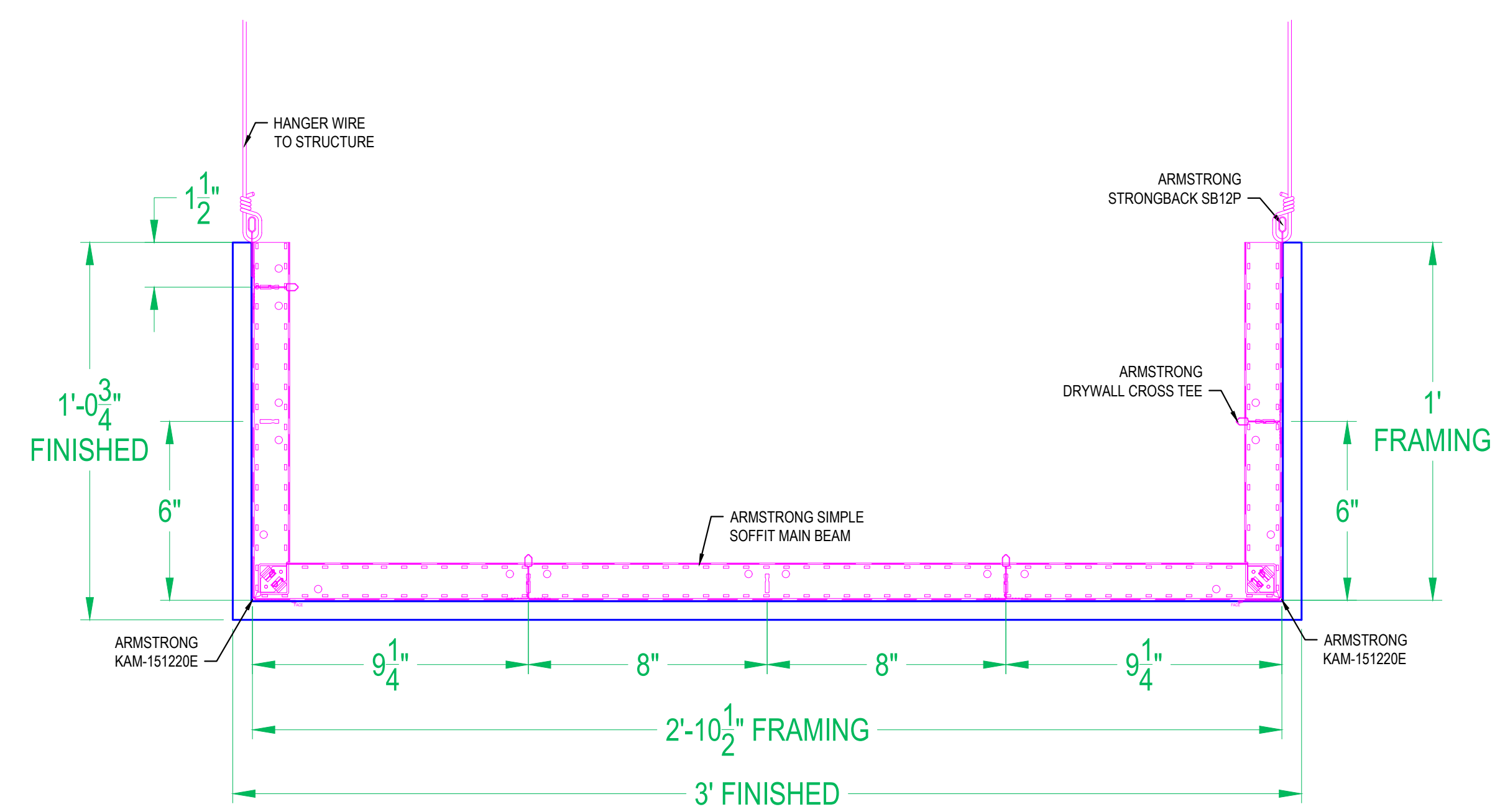

22 SIMPLE SOFFIT SSU123612

These drawings show typical conditions in which the Armstrong® product depicted is installed. They are not a substitute for an architect's or engineer's plan and do not reflect the unique requirements of local building codes, laws, statutes, ordinances, rules and regulations (Legal Requirements) that may be applicable for a particular installation.		PROJECT NAME: SIMPLE SOFFIT MASTER SHEET	
Armstrong Ceiling Solutions does not warrant, and assumes no liability for the accuracy or completeness of the drawings for a particular installation or their fitness for a particular purpose.		DWG. NO. SHEET 4	REV. DATE
The user is advised to consult with a duly licensed architect or engineer in the particular locale of the installation to assure compliance with all Legal Requirements.		DATE: 8/7/23	SCALE:
Armstrong is not licensed to provide professional architecture or engineering design services.		DRAWN BY: MAP	CHK BY:
TechLine		ARMSTRONG CEILING & WALL SOLUTIONS • Lancaster, PA • Phone: 877-ARMSTRONG	

