

NOTE:

- 1'X4' PANEL - 3x 1" WIDE BY 1-3/8" DEEP SLATS

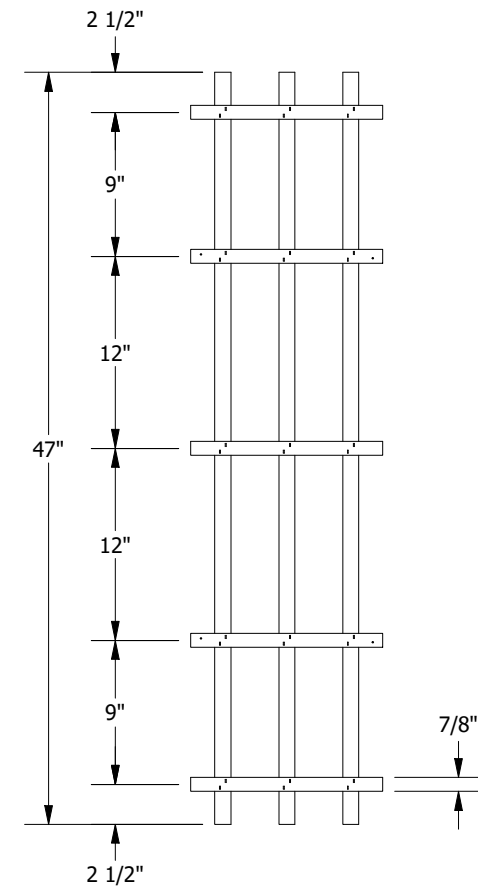
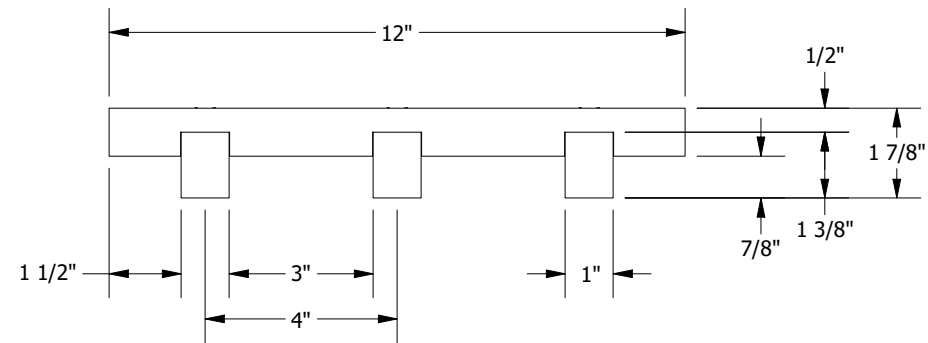
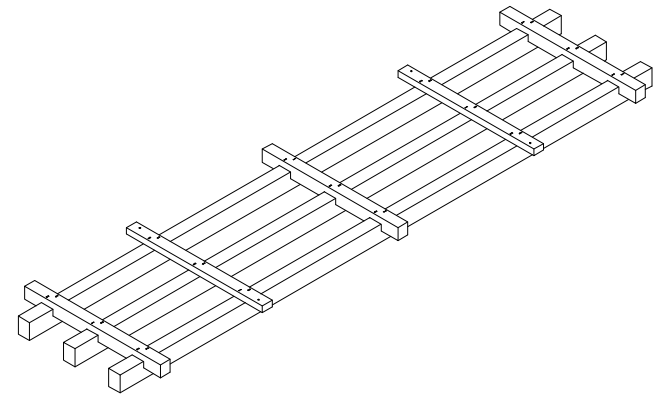

WOODWORKS GRILLE FORTÉ
SOLID WOOD PANEL BP6323L4S05

DRAWN BY: APF DATE: 6/14/2022 PD

These drawings show typical conditions which the Armstrong products depicted are installed. They are not a substitute for an architect's or engineer's plan and do not reflect the unique requirements of local building codes, laws, statutes, ordinances, rules and regulations (Legal Requirements) that may be applicable for a particular installation. Armstrong does not warrant, and assumes no liability for the accuracy or completeness of the drawings for a particular installation or their fitness for a particular purpose. The user is advised to consult with a duly licensed architect or engineer in the particular locale of the installation to assure compliance with all legal requirements. Armstrong is not licensed to provide professional architecture or engineering design services.